

Material :

- (a) Cover : PA66(UL94V-0)
- (b) Contact : Phosphor Bronze
- (c) Cage : Brass , Ni Plated
- (d) Housing : PA66(UL94V-0)
- (e) Screws : Steel , Cr³⁺Zn Plated

Electrical :

- | | | |
|------------------------------|------------------|--------------------|
| | UL | IEC |
| 1.Rated Voltage : | 300V | 320V |
| 2.Rated Current : | 15A | 10A |
| 3.Torque Value : | M2.5 , 3.54Lb.in | M2.5 , 0.4N.m |
| 4.Wire Range: | 28-12AWG | 2.5mm ² |
| 5.Stripping Length : | 7-8mm | |
| 6.Withstanding Voltage : | AC1600V/1Min. | |
| 7.Operating Temperature : | -40 °C~+105 °C | |
| 8.RoHS Compliance | | |
| 9.Safety Approval : | cULus | |
| 10.Undimensioned Tolerances: | | |

Pitch Range In mm		Nominal Dimension Range In mm						
≤6	6 ~ 10	10 ~ 24	≤30	30 ~ 60	60 ~ 100	100 ~ 150	>150	0.05/10
±0.10	±0.15	±0.25	±0.20	±0.30	±0.50	±0.70	±1.00	±0.1°

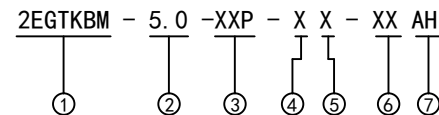

- ① Series NO.
- ② Pitch
- ③ Poles
02 02Contacts
03 03Contacts
...
24 24Contacts
- ④ 1 Single Pitch
2 Double Pitch
- ⑤ Color: 1 Grey
2 Blue
3 Black
4 Green(Standard For AH)
5 Orange
6 Red
7 Transparent
8 Yellow
9 White
- ⑥ Customer Request: 00--Standard M2.5
- ⑦ AH--Standard(PA66)

DETACHED LISTS	Grolten 宁波冠泰电子有限公司 NINGBO GOLTEN ELECTRONICS CO., LTD.							
	APPD: MA_9/16/16'	PART NO. 2EGTKBM-5.0-XXP-XX-00AH						
	CHKD: Yu_9/15/16'							
	DRFT: Chen_9/14/16'							
 THIRD ANGLE PROJECTION		<table border="1"> <tr> <td>REV</td> <td>1</td> </tr> <tr> <td>SHEET</td> <td>1/1</td> </tr> <tr> <td>SCALE</td> <td>1/1</td> </tr> </table>	REV	1	SHEET	1/1	SCALE	1/1
REV	1							
SHEET	1/1							
SCALE	1/1							
 MM (INCH) DO NOT SCALE DRAWING								

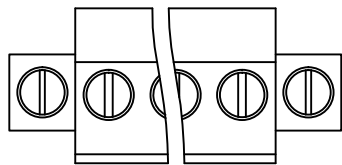

Material :

- ① Cover : PA66(UL94V-0)
- ② Contact : Phosphor Bronze
- ③ Cage : Brass , Ni Plated
- ④ Housing : PA66(UL94V-0)
- ⑤ Screws : Steel , Cr³⁺Zn Plated

Electrical :

- | | | |
|-------------------------------|------------------|--------------------|
| | UL | IEC |
| 1. Rated Voltage : | 300V | 320V |
| 2. Rated Current : | 15A | 10A |
| 3. Torque Value : | M2.5 , 3.54Lb.in | M2.5 , 0.4N.m |
| 4. Wire Range : | 28-12AWG | 2.5mm ² |
| 5. Stripping Length : | 7-8mm | |
| 6. Withstanding Voltage : | AC1600V/1Min. | |
| 7. Operating Temperature : | -40 °C~+105 °C | |
| 8. RoHS Compliance | | |
| 9. Safety Approval : | | |
| 10. Undimensioned Tolerances: | | |

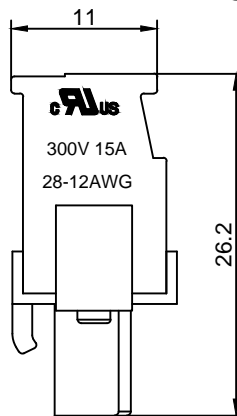
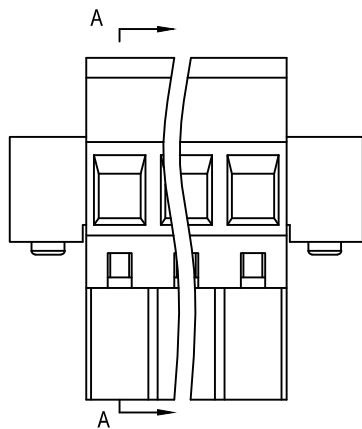
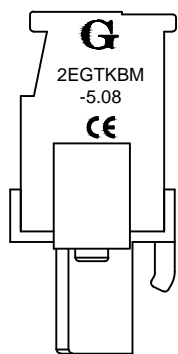

Pitch Range In mm		Nominal Dimension Range In mm				0.05/10	0.1°
≤6	6 ~ 10	≤30	30 ~ 60	60 ~ 100	100 ~ 150		
±0.10	±0.15	±0.25	±0.20	±0.30	±0.50	±0.70	±1.00

2EGTKBM - 5.08 -XXP - X X - XX AH

① ② ③ ④ ⑤ ⑥ ⑦

- ① Series NO.
- ② Pitch
- ③ Poles
02 02Contacts
03 03Contacts
...
24 24Contacts
- ④ 1 Single Pitch
2 Double Pitch
- ⑤ Color: 1 Grey
2 Blue
3 Black
4 Green(Standard For AH)
5 Orange
6 Red
7 Transparent
8 Yellow
9 White
- ⑥ Customer Request: 00--Standard M2.5
- ⑦ AH--Standard(PA66)

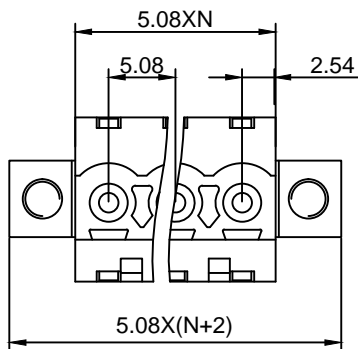
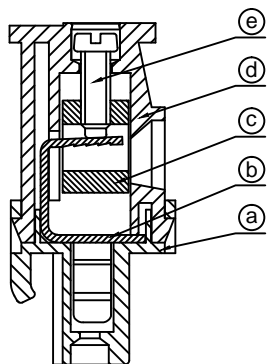

DETACHED LISTS			宁波冠泰电子有限公司 NINGBO GOLTEN ELECTRONICS CO., LTD.	
	APPD: MA_9/16/16'	PART NO. 2EGTKBM-5.08-XXP-XX-00AH		
	CHKD: Yu_9/15/16'	DRAWING NO.		
	DRFT: Chen_9/14/16'	DO NOT SCALE DRAWING		REV 1
THIRD ANGLE PROJECTION		MM (INCH)	SCALE 1/1	SHEET 1/1