

## Single phase - general purpose

Comprehensive family of single and multi-stage chassis mount filters. Throughout the power range, a high level of performance is provided within various sizes and styles of metal enclosure and termination options.

Designed to provide economic solutions to a multitude of general purpose filtering requirements; industrial power equipment, office, business and medical equipments.

The two stage FAS series is specifically designed to suppress RFI generated by switch mode power supply applications.

- Current ratings from 0.5A to 40A
- High symmetric and asymmetric attenuation
- Earth line choke and medical versions available
- Custom designs to client specifications

### Mechanical Specifications

Manufacture: metal case and cover, internal components sealed with self-extinguishing resin.

Connections: faston 6.3 x 0.8mm ( $\leq 16A$ ),  
flexible leads, screws M4 ( $\leq 40A$ )  
ground terminal connected to case.

### Electrical Specifications

Rated voltage ( $V_R$ ): max 250V, 50/60Hz

Rated current ( $I_R$ ): referred to room temperature = 40°C

Leakage current ( $I_L$ ): at 220V, 50Hz, max value

Voltage test ( $2_s$ ): line to ground 3000Vdc or 1800Vac  
line to line 1700Vdc

Climatic category: HPF (25/085/21);

Temperature range: -25°C to +85°C

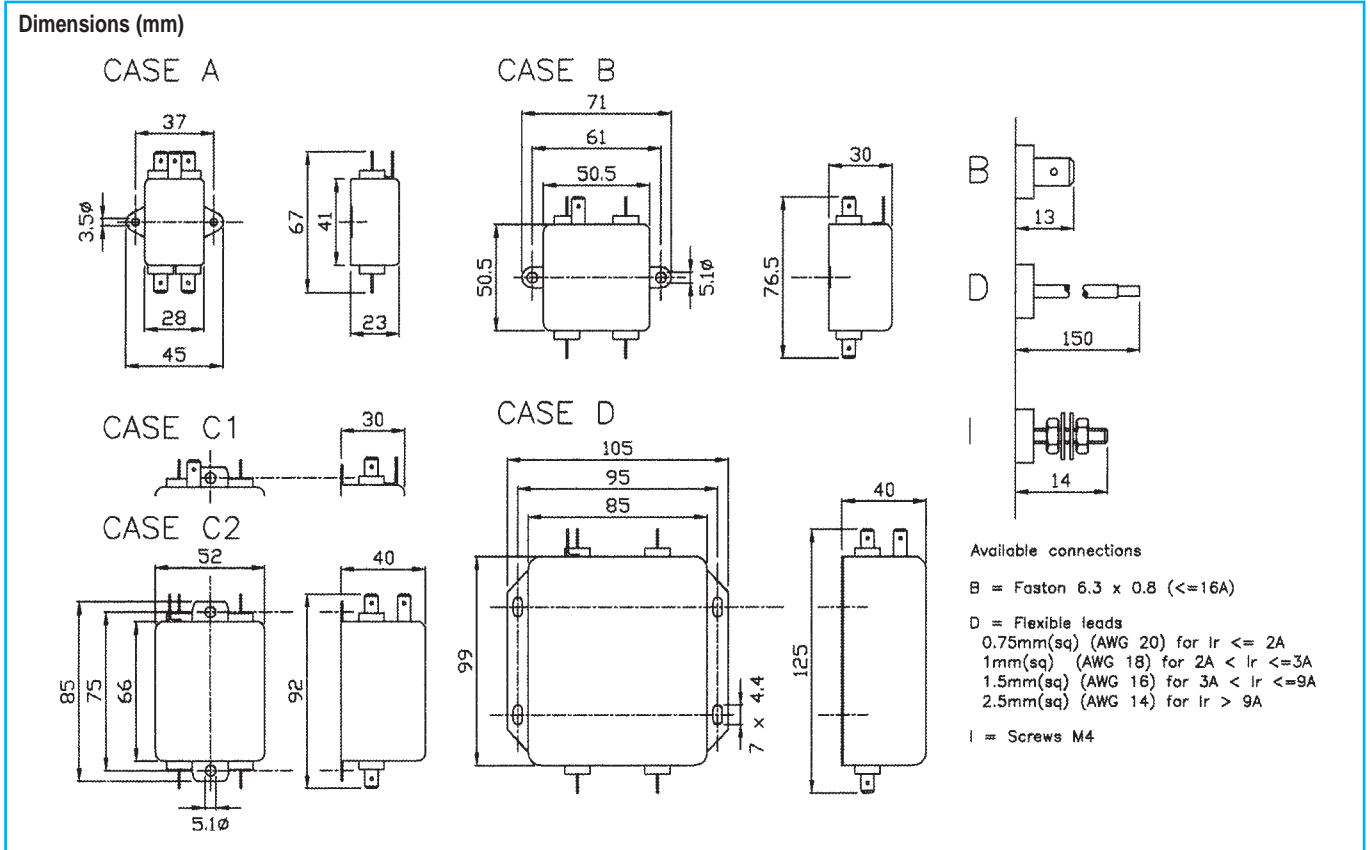

# Chassis Mount Filters

# F.AI-F.AM-F.AK-F.AR-F.AS series

## F.AR

Insertion loss (typical): — Asymmetrical (line to ground)    - - - Symmetrical (line to line)

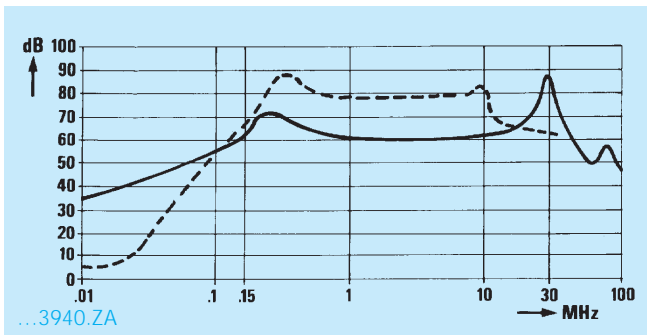
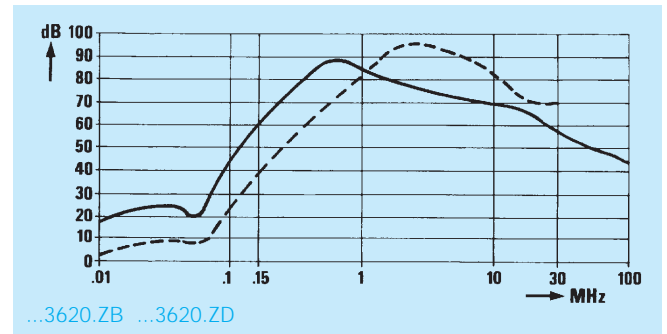
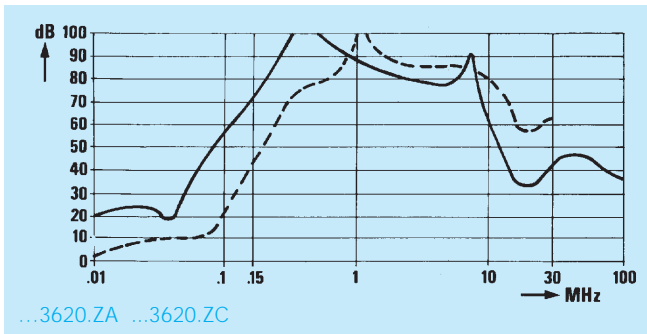

## F.AS

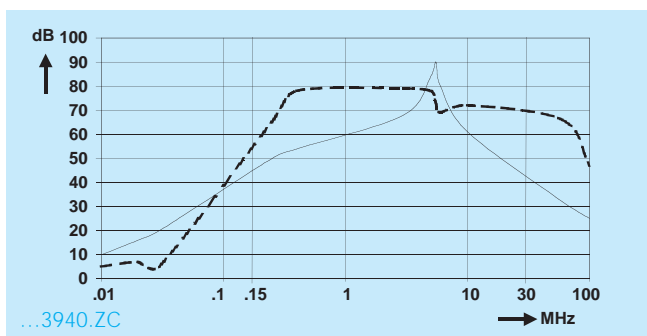
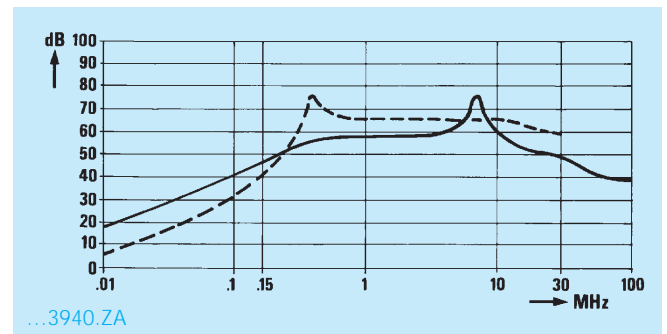
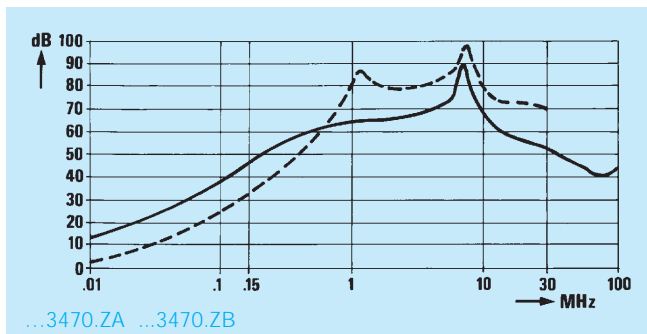
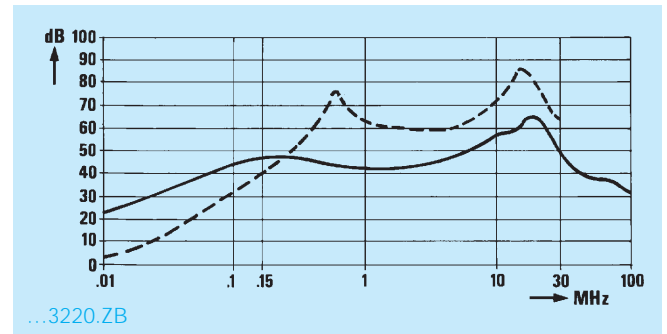
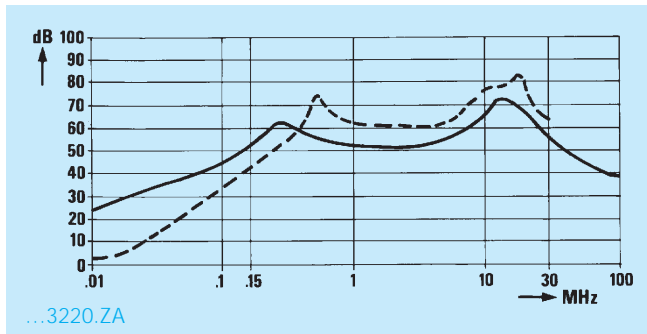

## F.AK

Insertion loss (typical): — Asymmetrical (line to ground) - - - Symmetrical (line to line)

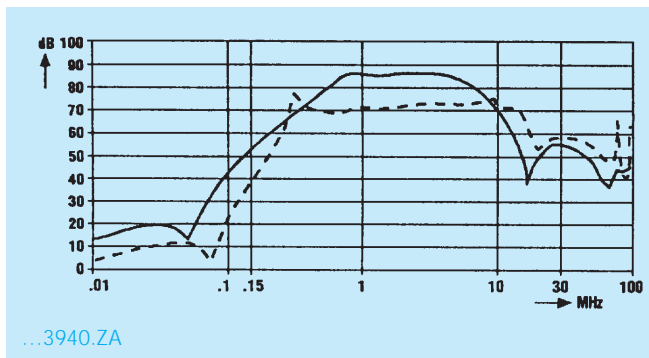
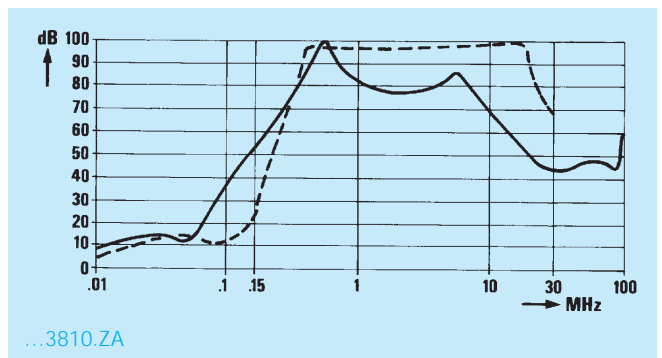
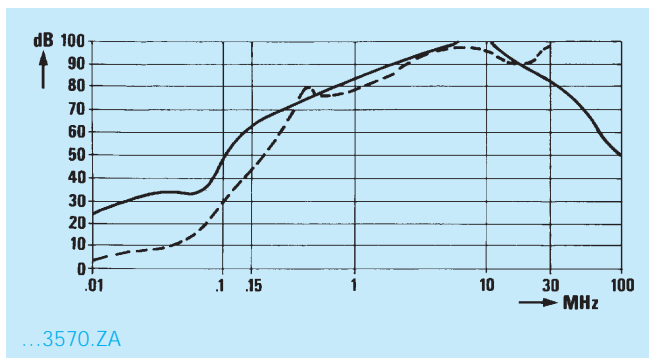
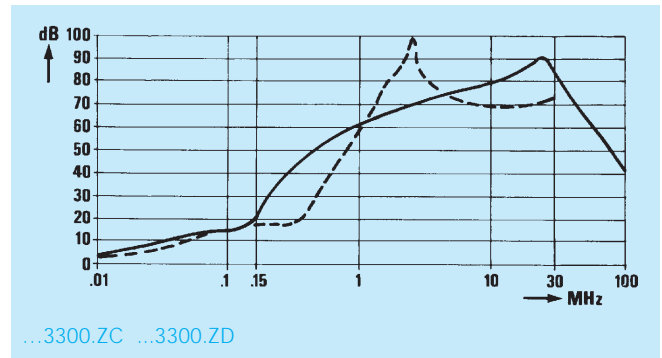
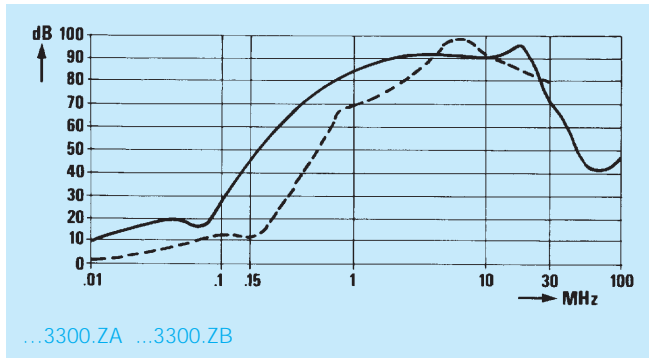

# Chassis Mount Filters

# F.AI-F.AM-F.AK-F.AR-F.AS series

Insertion loss (typical): — Asymmetrical (line to ground)    - - - Symmetrical (line to line)

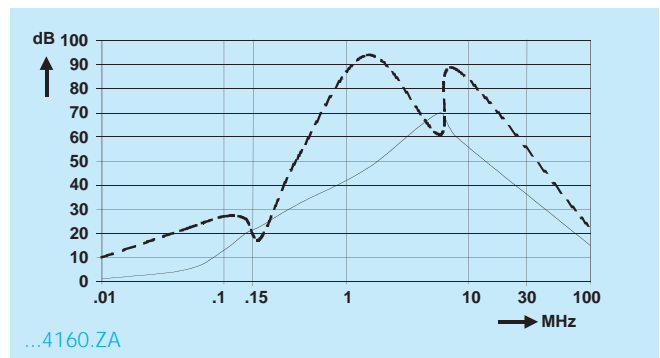
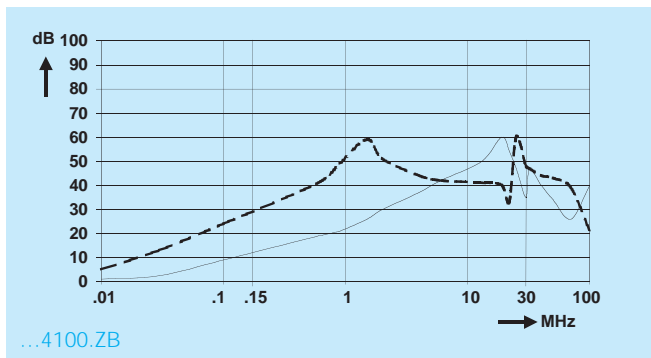
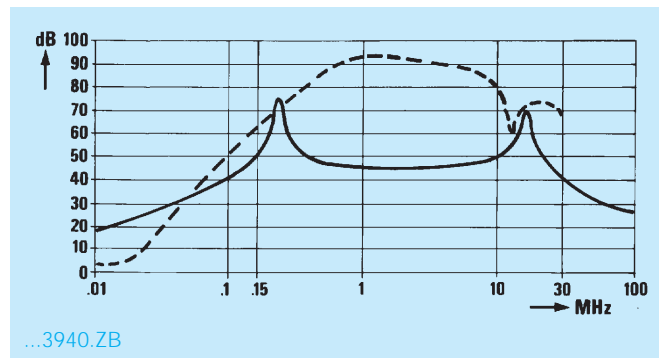
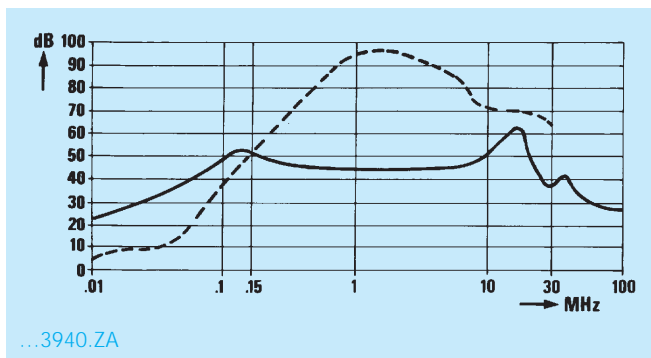
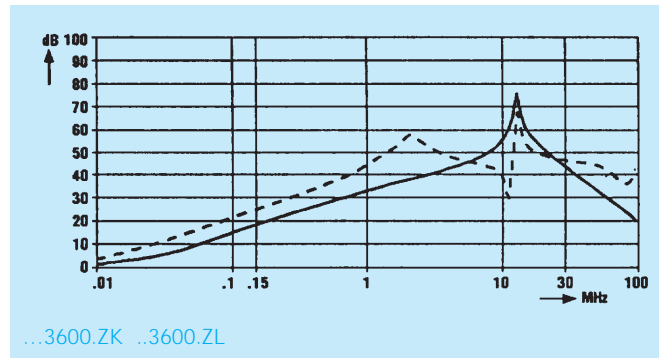
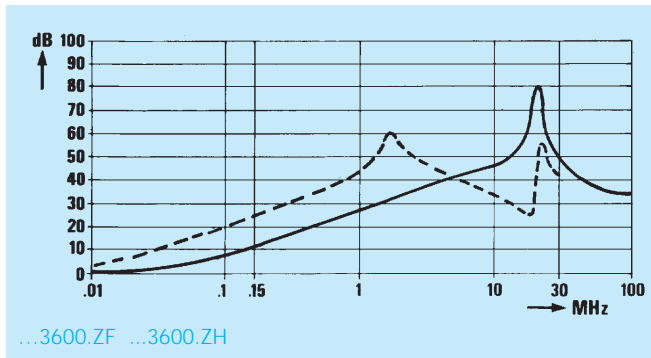

# Chassis Mount Filters

# F.AI-F.AM-F.AK-F.AR-F.AS series

## Filter Range

F.AI Code	I <sub>r</sub> (A)	L (mH)	C <sub>x</sub> (μF)	C <sub>y</sub> (pF)	I <sub>L</sub> (mA)	R (MΩ)	Circ Diag	Case
F.AI.DB.2150.ZA	1.5	2x10	0.015	2x2200	2x0.2		A	A
F.AI.DB.2150.ZB	1	2x10	0.015	2x2200	2x0.2		A	A
F.AI.DB.2150.ZC	3	2x2	0.015	2x2200	2x0.2		A	A
<b>F.AI.DB.2150.ZD</b>	<b>6.5</b>	<b>2x1</b>	<b>0.015</b>	<b>2x2200</b>	<b>2x0.2</b>		<b>A</b>	<b>A</b>
F.AI.D-.2330.ZA	10	2x0.5	0.033	2x2200	2x0.2	1	B	B
F.AI.D-.2330.ZB	20	2x0.5	0.033	2x2200	2x0.2	1	B	B
F.AI.D-.2330.ZC	30	2x0.6	0.033	2x2200	2x0.2	1	B	D
F.AI.D-.3100.ZA	5	2x1	0.1	2x3200	2x0.29	1	B	B
F.AI.D-.3100.ZB	5	2x1.7	0.1	2x3200	2x0.29	1	B	B

B = Faston 6.3x0.8 mm  
D = Flexible leads  
I = Screws M4

F.AK Code	I <sub>r</sub> (A)	L <sub>1</sub> (mH)	L <sub>2</sub> (mH)	C <sub>x1</sub> (μF)	C <sub>x2</sub> (μF)	C <sub>x3</sub> (pF)	C <sub>y1</sub> (pF)	C <sub>y2</sub> (pF)	I <sub>L</sub> (mA)	R (MΩ)	Circ Diag	Case
FAK.D-.3300.ZA	3	2x2	2x2	0.15	0.15		2x2200		2x0.2	1	E	C1
FAK.D-.3300.ZB	6	2x1	2x1	0.15	0.15		2x2200		2x0.2	1	E	C1
FAK.D-.3300.ZC	10	2x0.5	2x0.5	0.15	0.15		2x2200		2x0.2	1	E	C2
FAK.D-.3300.ZD	20	2x0.5	2x0.5	0.15	0.15		2x2200		2x0.2	1	E	D
FAK.D-.3570.ZA	2.5	2x1	2x25		0.47	0.1	2x3300	2x3300	2x0.6	0.68	E	D
FAK.D-.3810.ZA	10	2x2.3	2x2.3	0.27	0.27	0.27	2x5500	2x1000	2x0.6	0.33	E	D
■ FAK.D-.3940.ZA	3	2x4.7	2x4.7	0.47	0.47		2x4700		2x0.5	0.24	F	C2

B = Faston 6.3x0.8 mm  
D = Flexible leads  
I = Screws M4

ENI33200  
■ UL approval only

F.AM Code	I <sub>r</sub> (A)	L (mH)	C <sub>x1</sub> (μF)	C <sub>x2</sub> (μF)	C <sub>y</sub> (pF)	I <sub>L</sub> (mA)	R (MΩ)	Circ Diag	Case
F.AM.D-.3200.ZA	1	2x40	0.1	0.1	2x4700	2x0.43	0.68	C	B
F.AM.D-.3200.ZB	5	2x1	0.1	0.1	2x3200	2x0.29	0.68	C	B
F.AM.D-.3200.ZC	10	2x0.5	0.1	0.1	2x2200	2x0.20	0.68	C	B
F.AM.D-.3200.ZD	20	2x0.5	0.1	0.1	2x2200	2x0.20	0.68	C	C2
F.AM.D-.3200.ZE	30	2x0.6	0.1	0.1	2x2200	2x0.20	0.68	C	D
▲ F.AM.D-.3440.ZA	10	2x1	0.22	0.22	2x4700	2x0.43	0.47	D	B
F.AM.D-.3470.ZA	6.5	2x4		0.47	2x1000	2x0.09	0.68	C	C2
F.AM.D-.3600.ZC	16	2x1		0.6	2x2500	2x0.23	0.47	C	C2
F.AM.D-.3600.ZD	22	2x0.2		0.6	2x2500	2x0.23	0.47	C	C2
▲ F.AM.D-.3600.ZE	20	2x1		0.6	2x4700	2x0.43	0.47	D	C2
▲ F.AM.D-.3600.ZF	40	2x0.23		0.6	2x4700	2x0.43	0.47	D	C2
▲ F.AM.D-.3600.ZH	30	2x0.23		0.6	2x4700	2x0.43	0.47	D	C2
▲ F.AM.D-.3600.ZK	25	2x0.5	0.6		2x4700	2x0.43	0.47	D	C2
▲ F.AM.D-.3600.ZL	25	2x0.5	0.6		2x22000	2x2.0	0.47	D	C2
F.AM.D-.3940.ZA	4.5	2x20	0.47	0.47	2x10000	2x0.91	0.33	C	C2
F.AM.D-.3940.ZB	3.3	2x13	0.47	0.47	2x6800	2x0.62	0.33	C	C2
■ F.AM.D-.4100.ZB	16	2x0.5		1.0	2x2500	2x0.23	0.33	D	C2
▲ F.AM.D-.4160.ZA	25	2x0.5	1.0	0.68	2x22000	2x2.0	0.47	C	C2

B = Faston 6.3x0.8mm  
D = Flexible leads  
I = Screws M4

▲ ENI33200 only  
■ UL approval only

## Circuit diagram

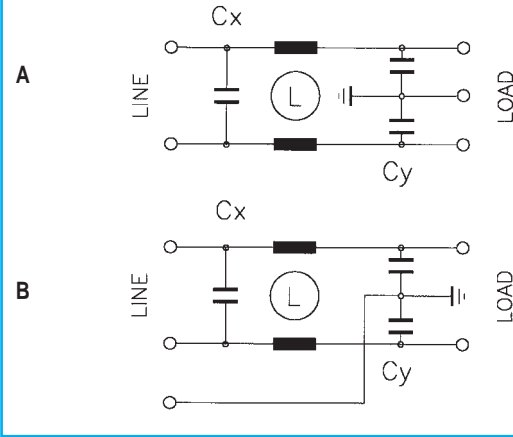

## Circuit diagram

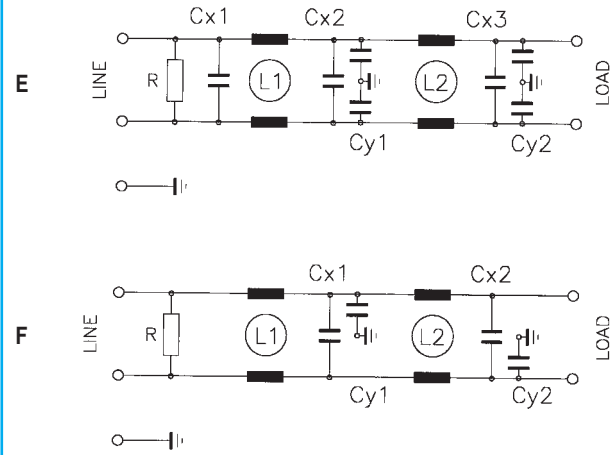

## Circuit diagram

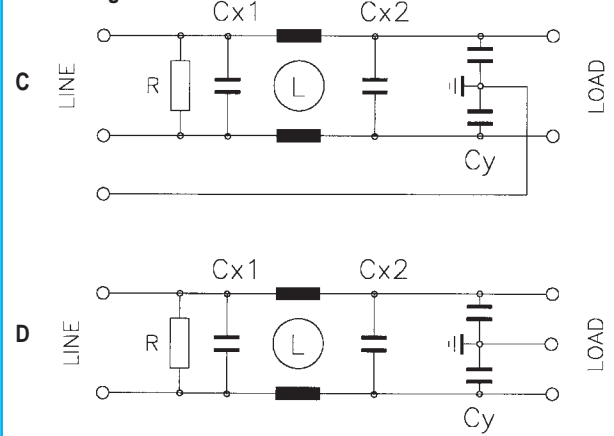

# Chassis Mount Filters

# F.AI-F.AM-F.AK-F.AR-F.AS series

## F.AM

Insertion loss (typical): — Asymmetrical (line to ground)    - - - Symmetrical (line to line)

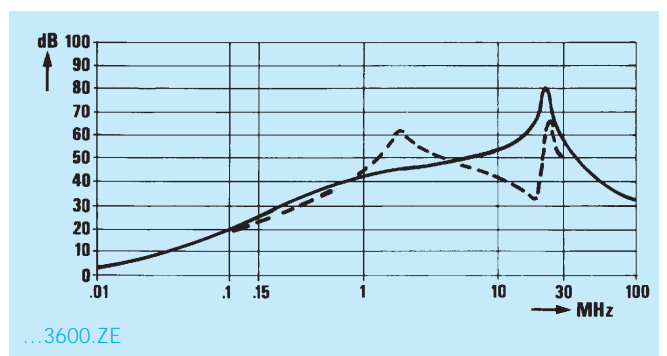
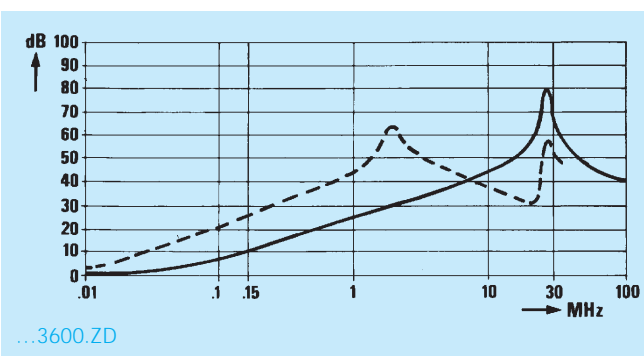
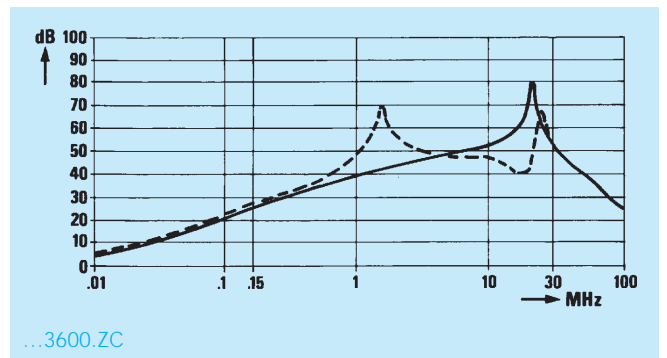
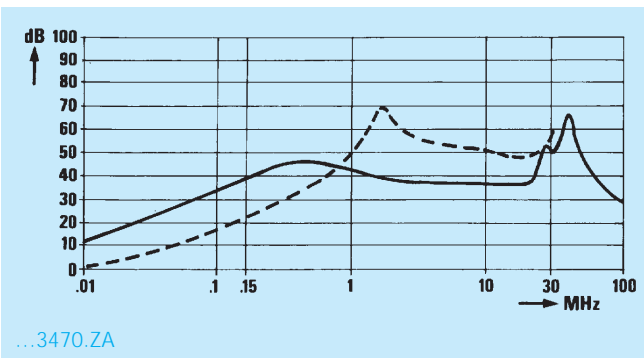
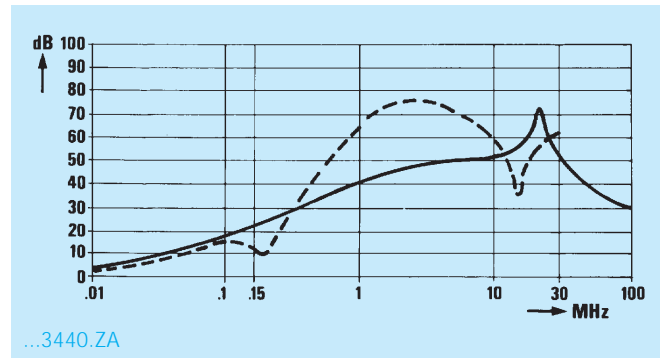
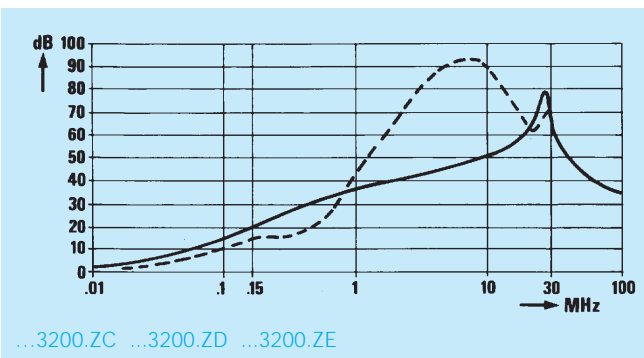
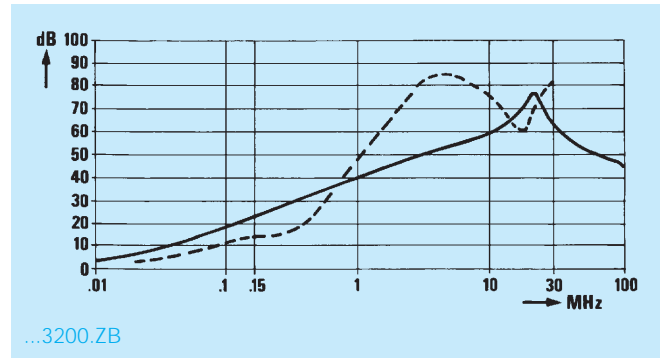
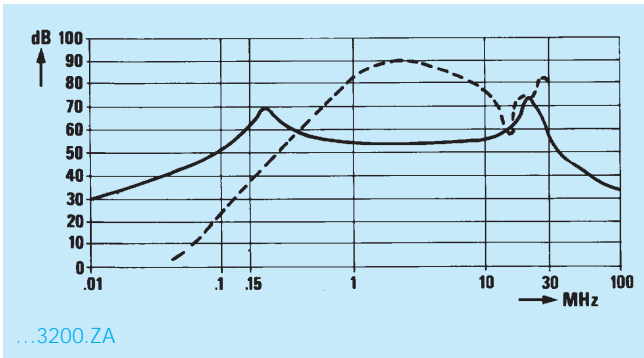

# Chassis Mount Filters

# F.AI-F.AM-F.AK-F.AR-F.AS series

## F.AR

F.AR Code	I <sub>r</sub> (A)	L <sub>1</sub> (mH)	L <sub>2</sub> (mH)	C <sub>x1</sub> (μF)	C <sub>x2</sub> (μF)	C <sub>y1</sub> (pF)	C <sub>y2</sub> (pF)	I <sub>L</sub> (mA)	R (MΩ)	Circ	Case
F.AR.D-.3620.ZA	1.5	2x7	2x7	0.47	0.15		2x2200	2x0.2	0.47	G	C2
F.AR.D-.3620.ZB	2.5	2x12	2x2	0.47	0.15		2x2200	2x0.2	0.47	G	C2
F.AR.D-.3620.ZC	5	2x7	2x7	0.47	0.15		2x2200	2x0.2	0.47	G	C2
F.AR.D-.3620.ZD	8.5	2x10	2x3	0.47	0.15		2x2200	2x0.2	0.47	G	D
▲ F.AR.D-.3940.ZA	0.5	2x40	2x40	0.47	0.47	2x3300		2x0.3	0.33	G	C1

B = Faston 6.3x0.8mm  
 D = Flexible leads  
 I = Screws M4

▲ ENI33200 only

## Circuit diagram

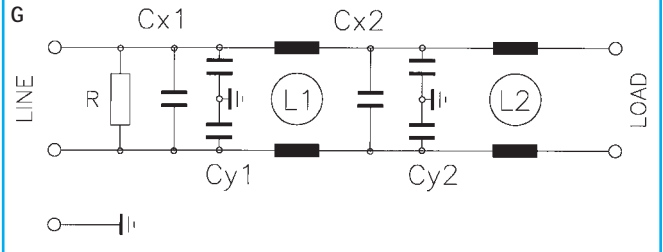

## F.AS

F.AS Code	I <sub>r</sub> (A)	L <sub>1</sub> (mH)	L <sub>2</sub> (mH)	C <sub>x1</sub> (μF)	C <sub>y</sub> (pF)	I <sub>L</sub> (mA)	R (MΩ)	Circ	Case
F.AS.D-.3220.ZA	1	2x22	2x0.3	0.22	2x4700	2x0.43	1	H	B
F.AS.D-.3220.ZB	2.5	2x16	2x0.3	0.22	2x4700	2x0.43	1	H	C2
F.AS.D-.3470.ZA	6.5	2x4	2x0.05	0.47	2x22000	2x2	0.47	H	D
F.AS.D-.3470.ZB	10	2x4	2x0.05	0.47	2x22000	2x2	0.47	H	D
F.AS.D-.3940.ZA	4	2x8	2x0.05	0.94	2x22000	2x2	0.33	H	C2
▲ F.AS.D-.3940.ZC	10	2x4	2x0.05	2x0.47	2x22000	2x2	0.33	H	D

B = Faston 6.3x0.8mm  
 D = Flexible leads  
 I = Screws M4

▲ ENI33200 only

## Circuit diagram

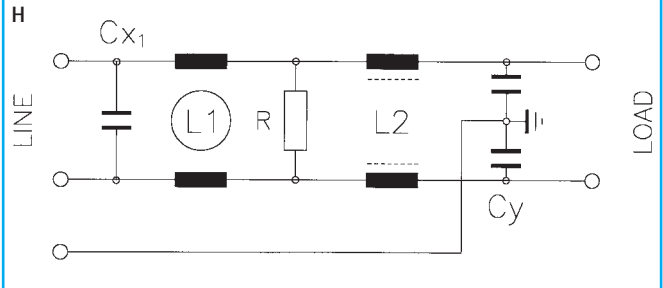

## F.AI

Insertion loss (typical): — Asymmetrical (line to ground)    - - - Symmetrical (line to line)

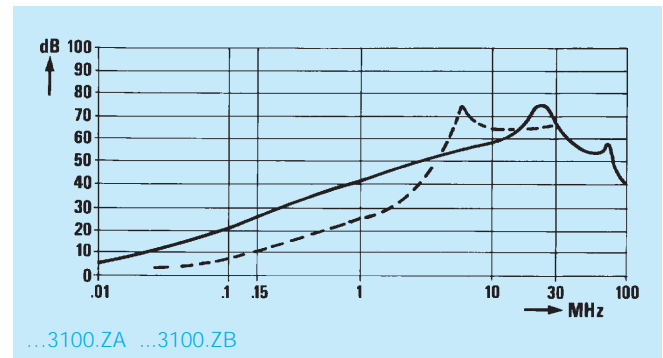
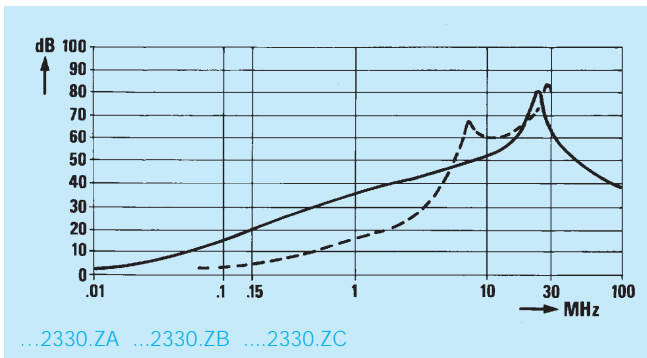
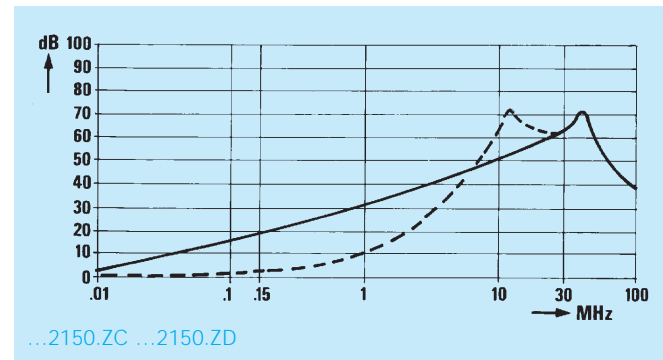
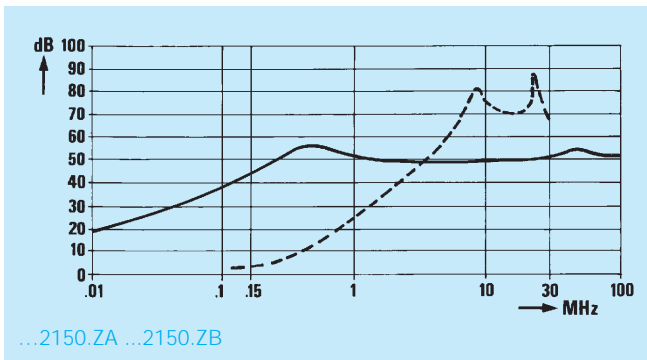

Approvals

