

# MORNSUN®

## VRA\_YMD-6WR2 & VRB\_YMD-6WR2 Series 6W, WIDE INPUT, ISOLATED & REGULATED DUAL/SINGLE OUTPUT DIP PACKAGING, DC-DC CONVERTER



Patent Protection RoHS

### PART NUMBER SYSTEM

VRB1205YMD-6WR2

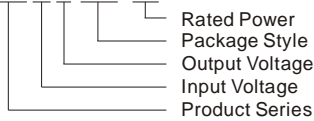

### FEATURES

- 2:1 wide input voltage range
- Efficiency up to 88%
- 1500VDC isolation
- Short circuit protection
- Output over voltage protection
- Operating temperature range: -40°C ~ +85°C
- Industry standard pinout
- Low ripple & noise
- Meet CISPR22/EN55022 CLASS A

### APPLICATION

The VRA\_YMD-6WR2 & VRB\_YMD-6WR2 series offer 6W of output, with wide input voltage of 9-18VDC, 18-36VDC, 36-75VDC and 1500VDC isolation voltage, output over-voltage and short-circuit protection. The products meet CISPR22/EN55022 CLASS A. All models are particularly suitable for industrial, electric power, instrumentation, telecommunication applications.

### SELECTION GUIDE

Model Number	Input Voltage(VDC)		Output Voltage (VDC)	Output Current (mA)		Input Current (mA)(Typ.)		Reflected Ripple Current (mA, Typ.)	Max. Capacitive Load# (μF)	Efficiency (% , Typ.) @Max. Load
	Nominal (Range)	Max **		Max.	Min.	@Max. Load	@No load			
*VRA1205YMD-6WR2	12 (9-18)	20	±5	±600	±30	617	12	20	470	81
*VRA1212YMD-6WR2			±12	±250	±12	588			100	85
*VRA1215YMD-6WR2			±15	±200	±10	588			100	85
VRB1203YMD-6WR2			3.3	1500	75	528			1800	78
VRB1205YMD-6WR2			5	1200	60	617			1000	81
VRB1212YMD-6WR2			12	500	25	588			100	85
VRB1215YMD-6WR2			15	400	20	588			100	85
VRB1224YMD-6WR2			24	250	12	581			47	86
*VRA2405YMD-6WR2	24 (18-36)	40	±5	±600	±30	301	9	20	470	83
*VRA2412YMD-6WR2			±12	±250	±12	287			100	87
VRA2415YMD-6WR2			±15	±200	±10	287			100	87
VRB2403YMD-6WR2			3.3	1500	75	261			1800	79
VRB2405YMD-6WR2			5	1200	60	301			1000	83
VRB2412YMD-6WR2			12	500	25	287			100	87
VRB2415YMD-6WR2			15	400	20	287			100	87
VRB2424YMD-6WR2			24	250	12	287			47	87
*VRA4805YMD-6WR2	48 (36-75)	80	±5	±600	±30	151	3	20	470	83
*VRA4812YMD-6WR2			±12	±250	±12	143			100	87
*VRA4815YMD-6WR2			±15	±200	±10	142			100	88
VRB4803YMD-6WR2			3.3	1500	75	130			1800	79
VRB4805YMD-6WR2			5	1200	60	151			1000	83
VRB4812YMD-6WR2			12	500	25	143			100	87
VRB4815YMD-6WR2			15	400	20	142			100	88
*VRB4824YMD-6WR2			24	250	12	142			47	88

Note: 1. \*Designing. \*\*Input voltage can't exceed this value, or will cause the permanent damage.  
2. # For each output.

## INPUT SPECIFICATIONS

Item	Test Conditions	Min.	Typ.	Max.	Unit
Input Surge Voltage (1sec. max.)	12V input	-0.7	--	25	VDC
	24V input	-0.7	--	50	
	48V input	-0.7	--	100	
Start-up Voltage	12V input	--	--	9	VDC
	24V input	--	--	18	
	48V input	--	--	36	
No-load Input Power		--	0.15	0.3	W
Input Filter		π Filter			

## OUTPUT SPECIFICATIONS

Item	Test Conditions	Min.	Typ.	Max.	Unit
Output Power		0.3	--	6	W
Output Voltage Accuracy		--	±1	±2	%
Output Voltage Balance	Dual output, Balance load	--	±0.5	±1.5	
Line Regulation	Full load, Input voltage from low to high	--	±0.2	±0.5	
Load Regulation	5% to 100% load	--	±0.5	±1	
Cross Regulation	Dual output, main output 50% load, Supplement output from 10% to 100% load	--	--	±5	
Transient Recovery Time	25% load step change	--	300	500	μs
Transient Response Deviation		--	±3	±5	%
Temperature Drift	100% load	--	--	±0.03	%/°C
Ripple*	20MHz Bandwidth	--	15	25	mVp-p
Noise*		--	50	75	
Output Over Voltage Protection	Input voltage range	110	--	140	%Vo
Output Short Circuit Protection		Continuous, automatic recovery			

Note: 1. Dual output models unbalanced load: ±5%.

2.\* Ripple and noise tested by "parallel cable" method. See detailed operation instructions at Testing of Power Converter section, application notes.

## COMMON SPECIFICATIONS

Item	Test Conditions	Min.	Typ.	Max.	Unit
Isolation Voltage	Tested for 1 minute and leakage current less than 1 mA	1500	--	--	VDC
Isolation Resistance	Test at 500VDC	1000	--	--	MΩ
Isolation Capacitance	Input/Output, 100KHz/0.1V	--	1000	--	pF
Switching Frequency		--	300	--	KHz
MTBF	MIL-HDBK-217F @ 25°C	1000	--	--	K hours
Case Material		Aluminum Alloy			
Weight		--	14	--	g

## ENVIRONMENTAL SPECIFICATIONS

Item	Test Conditions	Min.	Typ.	Max.	Unit
Storage Humidity	Non condensing	5	--	95	%
Operating Temperature	Power derating (above 71°C)	-40	--	85	°C
Storage Temperature		-55	--	125	
The Max. Case Temperature	Operating Temperature curve range	--	--	105	
Lead Temperature	1.5mm from case for 10 seconds	--	--	300	
Cooling		Free air convection			
Shake		10-55Hz, 10G, 30 Min. along X, Y and Z			

## EMC SPECIFICATIONS

EMI	CE	CISPR22/EN55022	CLASS A(Without External Circuit)/ CLASS B (External Circuit Refer to Figure 1-② or Figure 3)	
	RE	CISPR22/EN55022	CLASS A(Without External Circuit)/ CLASS B (External Circuit Refer to Figure 1-② or Figure 3)	
EMS	ESD	IEC/EN61000-4-2	Contact ±4KV perf. Criteria B	
	RS	IEC/EN61000-4-3	10V/m perf. Criteria A	
	EFT	IEC/EN61000-4-4	±2KV	perf. Criteria B (External Circuit Refer to Figure 1-①)
		IEC/EN61000-4-4	±4KV	perf. Criteria B (External Circuit Refer to Figure 3)
	Surge	IEC/EN61000-4-5	±2KV	perf. Criteria B (External Circuit Refer to Figure 1-① or Figure 3)
	Voltage dips, short and interruptions immunity	IEC/EN61000-4-29	0%-70%	perf. Criteria B

## EMC RECOMMENDED CIRCUIT

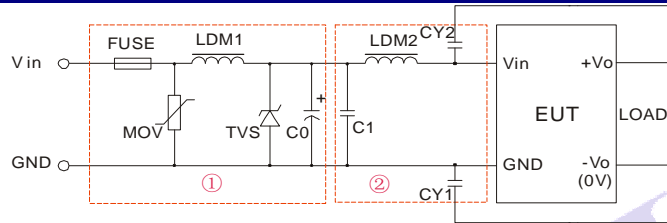

(Figure1)

Parameters	Vin: 12V	Vin: 24V	Vin: 48V
FUSE		Choose according to practical input current	
MOV	--	10D560K	10D101K
LDM1	--	56μH	
TVS	SMCJ28A	SMCJ48A	SMCJ90A
C0	680μF/25V	120μF/50V	120μF/100V
C1	1μF/50V		
LDM2		4.7μH	
CY1		1nF/2000V	
CY2		1nF/2000V	

Note: 1. In Figure 1, part ① is EMS Recommended external circuit, part ② is EMI recommended external circuit. Choose according to requirements.  
2. If there is no recommended parameters, the model no require the external component.

## EMC RECOMMENDED CIRCUIT PCB LAYOUT

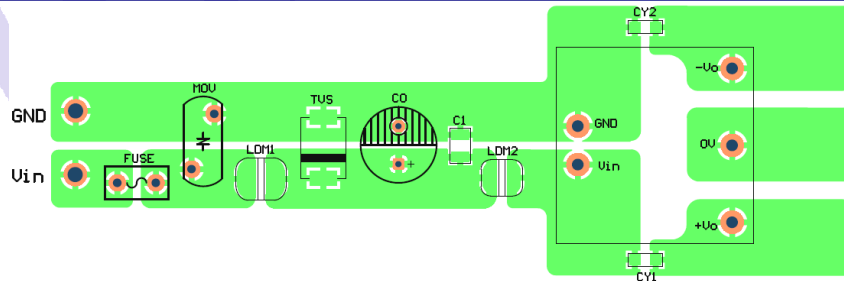

(Figure2)

## EMC MODULE RECOMMENDED CIRCUIT

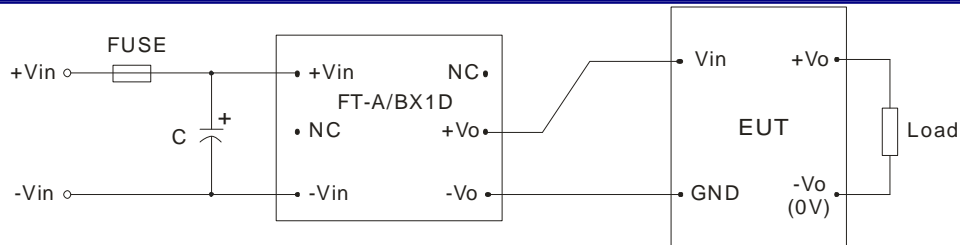

Nominal Voltage < 48V, C ≥ 330μF/50V  
Nominal Voltage = 48V, C ≥ 330μF/100V  
(Figure3)

# EMC MODULE RECOMMENDED CIRCUIT PCB LAYOUT

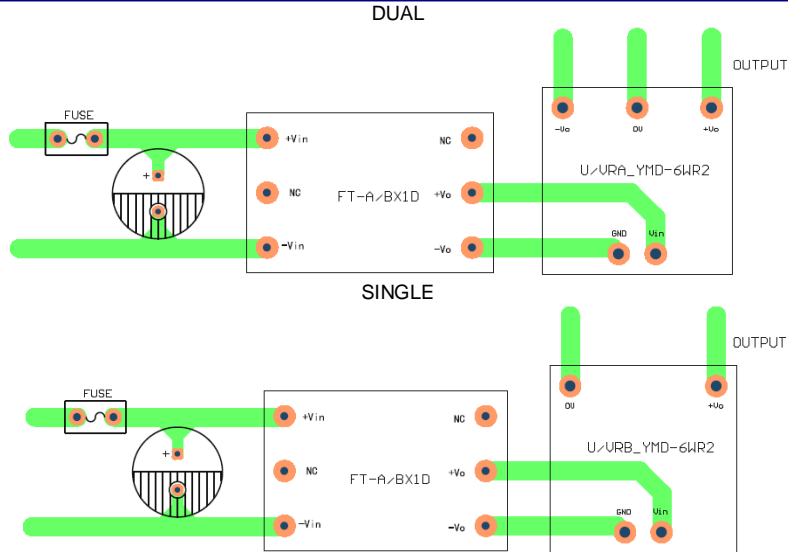

(Figure 4)

## EMI TEST WAVEFORM (NOMINAL AND FULL LOAD)

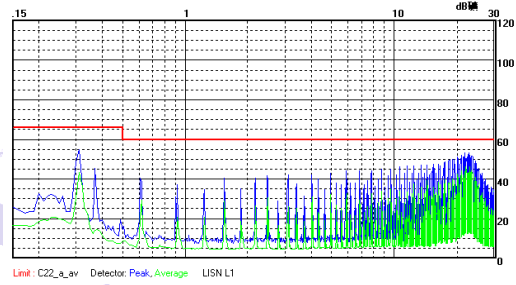
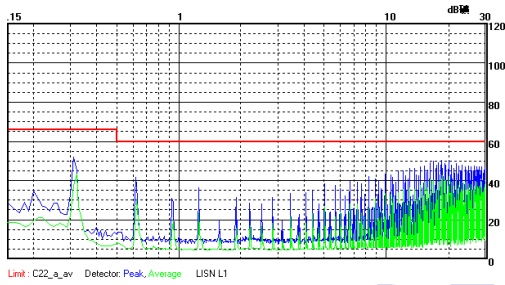

VRA2415YMD-6WR2 Without External Circuit Power+ (Class A)

VRB2405YMD-6WR2 Without External Circuit Power+ (Class A)

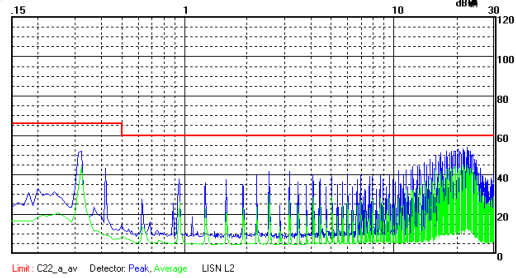
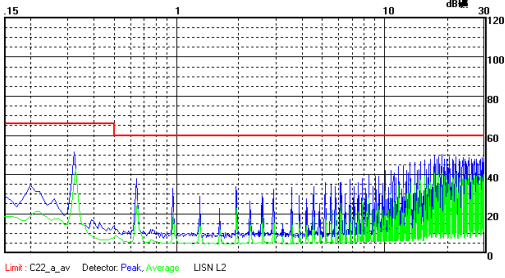

VRA2415YMD-6WR2 Without External Circuit Power- (Class A)

VRB2405YMD-6WR2 Without External Circuit Power- (Class A)

## PRODUCT TYPICAL CURVE

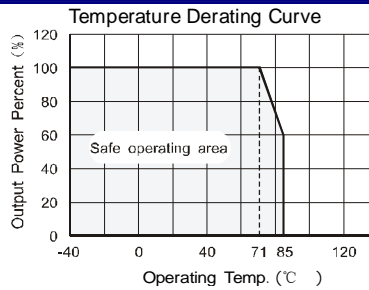

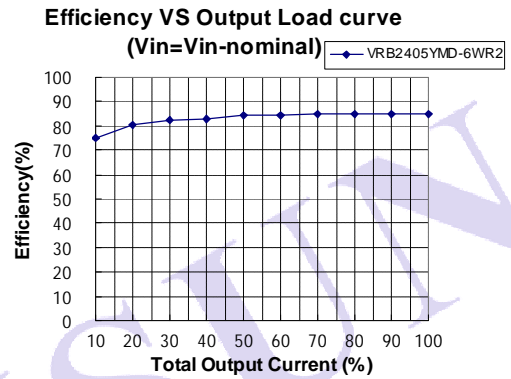
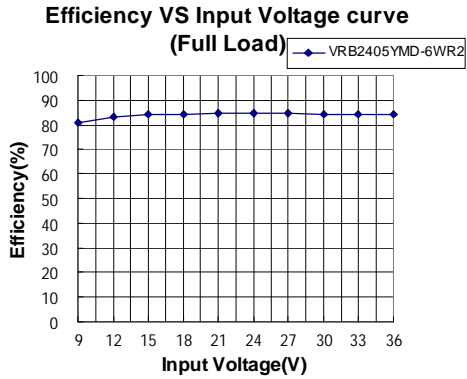
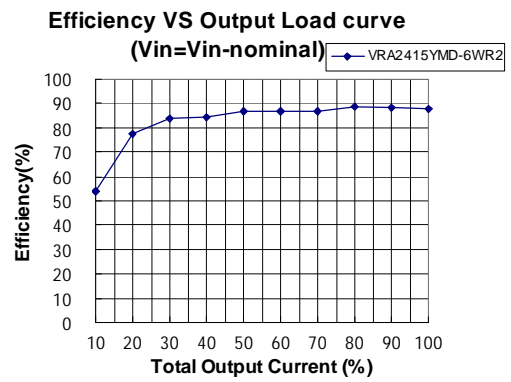
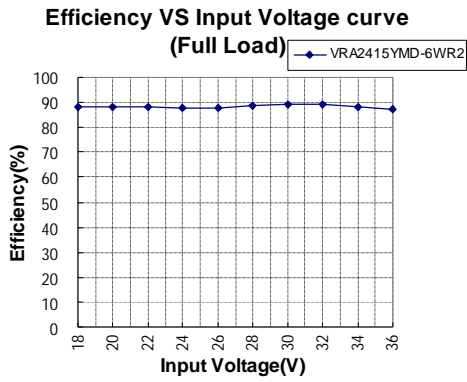

## OUTLINE DIMENSIONS, RECOMMENDED FOOTPRINT & PACKAGING

### MECHANICAL DIMENSIONS

(Front View)

(Bottom View)

Note:  
 Unit: mm[inch]  
 Pin diameter tolerances:  $\pm 0.10\text{mm} [\pm 0.004\text{inch}]$   
 Pin height tolerances:  $\pm 0.50\text{mm} [\pm 0.020\text{inch}]$   
 General tolerances:  $\pm 0.25\text{mm} [\pm 0.010\text{inch}]$

FOOTPRINT DETAILS		
Pin	SINGLE	DUAL
1	GND	GND
2	Vin	Vin
3	+Vo	+Vo
4	No Pin	0V
5	0V	-Vo

### RECOMMENDED FOOTPRINT

DUAL OUTPUT:

SINGLE OUTPUT:

Note: grid 2.54\*2.54mm.

### TUBE OUTLINE DIMENSIONS

Note:  
 Unit: mm[inch]  
 General tolerances:  $\pm 0.50\text{mm} [\pm 0.020\text{inch}]$   
 L=530mm[20.866inch] Devices per tube quantity: 19pcs  
 L=220mm[8.661inch] Devices per tube quantity: 7pcs  
 Short tube inner packaging dimensions:  
 L\*W\*H=255\*170\*80 mm;  
 Short tube outer packaging dimensions(with six inner packaging boxes):  
 L\*W\*H=375\*280\*270 mm;  
 Long tube inner packaging dimensions:L\*W\*H= 580\*200\*100 mm;  
 Long tube outer packaging dimensions(with two inner packaging boxes):  
 L\*W\*H=600\*215\*220 mm;  
 Long tube outer packaging dimensions(with three inner packaging boxes):  
 L\*W\*H=600\*215\*325 mm.

## TEST CONFIGURATIONS

### Input Reflected-Ripple Current Test Setup

Input reflected-ripple current is measured with an inductor  $L_{in}$  and Capacitor  $C_{in}$  to simulate source impedance.

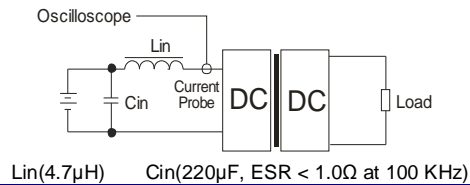

## DESIGN CONSIDERATIONS

### 1) Recommended circuit

All the VRA\_YMD-6WR2 & VRB\_YMD-6WR2 Series have been tested according to the following recommended testing circuit before leaving factory (see Figure 5). If you want to further decrease the output ripple, you can increase a capacitance properly or choose capacitors with low ESR, but the greatest capacitance of its filter capacitor must less than the Max. Capacitive Load.

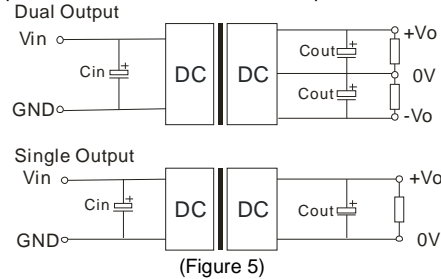

### 2) Cannot use in parallel and hot swap

Note:

1. Min. load shouldn't be less than 5%, otherwise ripple maybe increase dramatically. Operation under minimum load will not damage the converter, however, they may not meet all specification listed.
2. Max. Capacitive Load tested at input voltage range and full load.
3. All specifications measured at  $T_a=25^\circ\text{C}$ , humidity<75%, nominal input voltage and rated output load unless otherwise specified.
4. In this datasheet, all the test methods of indications are based on our corporate standards.
5. All characteristics are for listed model, non-standard models may perform differently, please contact our technical person for more detail.
6. Contact us for your specific requirement.
7. Specifications subject to change without prior notice.

### **MORNSUN Science & Technology Co.,Ltd.**

Address: No. 5, Kehui St. 1, Kehui development center, Science Ave., Guangzhou Science City, Luogang district, Guangzhou, P.R.China.

Tel: 86-20-28203030

Fax: 86-20-38601272

[Http://www.mornsun-power.com](http://www.mornsun-power.com)