

# MORNSUN®

## WRA\_ZP- 3WR2 & WRB\_ZP- 3WR2 Series 3W,WIDE INPUT, ISOLATED & REGULATED DUAL/SINGLE OUTPUT, DC-DC CONVERTER



Patent Protected RoHS

### PART NUMBER SYSTEM

WRA0505ZP - 3WR2

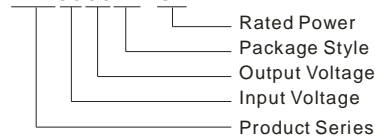

### FEATURES

- 2:1 wide input voltage range
- DIP Package
- Efficiency up to 86%
- 1.5KVDC isolation
- Short Circuit Protection(automatic recovery)
- Operating Temperature Range: -40°C ~ +85°C
- Meet CISPR22/EN55022 CLASS A

### APPLICATION

The WRA\_ZP-3WR2 & WRB\_ZP-3WR2 Series are specially designed for applications where a wide range input voltage power supplies are isolated from the input power supply in a distributed power supply system on a circuit board. For these DC-DC converters, you can reduce the failure points of design, and save the manpower, material and time cost in developing micro power supply, and also ensure better quality, stability, safety protection, and reliability for the end products.

These products apply to where:

- 1) Input voltage range  $\leq 2:1$ ;
- 2) 1.5KVDC input and output isolation;
- 3) Output regulated and low ripple noise is required.

### SELECTION GUIDE

Model	Input Voltage(VDC)		Output Voltage (VDC)	Output Current (mA)		Input Current (mA)(Typ.)		Reflected Ripple Current (mA,Typ.)	Max. Capacitive Load <sup>②</sup> (μF)	Efficiency (% ,Typ.) @Max. Load
	Nominal (Range)	Max. ①		Max.	Min.	@Max. Load	@No Load			
WRA0505ZP-3WR2	5 (4.5-9)	11	±5	±300	±15	790	40	20	2200	76
WRA0512ZP-3WR2			±12	±125	±6	770			1800	78
WRA0515ZP-3WR2			±15	±100	±5	770			1000	78
WRB0505ZP-3WR2			5	600	30	811			4700	74
WRB0512ZP-3WR2			12	250	12	780			2700	77
WRB0515ZP-3WR2			15	200	10	780			2200	77
WRA1205ZP-3WR2	12 (9-18)	20	±5	±300	±15	309	30	30	2200	81
WRA1209ZP-3WR2			±9	±166	±8	298			2000	84
WRA1212ZP-3WR2			±12	±125	±6	298			1800	84
WRA1215ZP-3WR2			±15	±100	±5	295			1000	85
WRB1203ZP-3WR2			3.3	909	46	338			4700	74
WRB1205ZP-3WR2			5	600	30	309			4700	81
WRB1212ZP-3WR2			12	250	12	302			2700	83
WRB1215ZP-3WR2			15	200	10	305			2200	82
WRB1224ZP-3WR2			24	125	6	302			1800	83
WRA2405ZP-3WR2			24 (18-36)	40	±5	±300			±15	153
WRA2412ZP-3WR2	±12	±125			±6	149	1800	84		
WRA2415ZP-3WR2	±15	±100			±5	149	1000	84		
WRB2403ZP-3WR2	3.3	909			46	160	4700	78		
WRB2405ZP-3WR2	5	600			30	155	4700	81		
WRB2412ZP-3WR2	12	250			12	146	2700	86		
WRB2415ZP-3WR2	15	200			10	146	2200	86		
WRB2424ZP-3WR2	24	125			6	147	1800	85		
WRA4805ZP-3WR2	48 (36-75)	80	±5	±300	±15	77	5	30	2200	82
WRA4812ZP-3WR2			±12	±125	±6	75			1800	84

WRA4815ZP-3WR2	48 (36-75)	80	±15	±100	±5	74	5	30	1000	85
WRB4803ZP-3WR2			3.3	909	46	82			4700	76
WRB4805ZP-3WR2			5	600	30	77			4700	82
WRB4812ZP-3WR2			12	250	12	73			2700	86
WRB4815ZP-3WR2			15	200	10	73			2200	86

Note: ①. Absolute maximum rating without damage on the converter, but it isn't recommended;  
 ②. For dual output converter, the given value is the same for each output.

### INPUT SPECIFICATIONS

Item	Test Conditions	Min.	Typ.	Max.	Unit
Input Surge Voltage (1sec. max.)	5VDC input	-0.7	--	12	VDC
	12VDC input	-0.7	--	25	
	24VDC input	-0.7	--	50	
	48VDC input	-0.7	--	100	
Start-up Voltage	5VDC input	3.5	4	4.5	VDC
	12VDC input	4.5	8	9	
	24VDC input	11	16	18	
	48VDC input	24	33	36	
Input Filter		Pi Filter			

### OUTPUT SPECIFICATIONS

Item	Test Conditions	Min.	Typ.	Max.	Unit
Output Voltage Accuracy	5% to 100% load	--	±1	±3	%
No load output Voltage Accuracy	Input voltage range	--	±1.5	±5	
Output Voltage Balance	Dual output, balanced loads	--	±0.5	±1	
Line Regulation	Full load, Input voltage from low to high	--	±0.2	±0.5	
Load Regulation	5% to 100% load	--	±0.2	±0.5	
Transient Recovery Time	25% load step change	--	0.5	2	ms
Transient Response Deviation		--	±2	±5	%
Temperature coefficient	100% load	--	±0.02	±0.03	%/°C
Ripple*	20MHz Bandwidth	--	15	30	mVp-p
Noise*		--	45	75	
Output Short Circuit Protection	Input voltage range	Continuous, automatic recovery			

Note: \* Ripple and noise tested with "parallel cable" method. See detailed operation instructions at *DC-DC application notes*.

### COMMON SPECIFICATIONS

Item	Test Conditions	Min.	Typ.	Max.	Unit
Isolation Voltage	Input-Output, Tested for 1 minute, leakage current less than 1 mA	1500	--	--	VDC
Isolation Resistance	Input-Output, Test at 500VDC	1000	--	--	MΩ
Isolation Capacitance	Input-Output, 100KHz/0.1V	--	120	--	pF
Switching Frequency(PFM mode)	100% load, nominal Input voltage	--	200	--	KHz
MTBF	MIL-HDBK-217F@25°C	1000	--	--	K hours
Case Material		Aluminum Alloy			
Weight		--	14	--	g

### ENVIRONMENTAL SPECIFICATIONS

Item	Test Conditions	Min.	Typ.	Max.	Unit
Storage Humidity	Non condensing	--	--	95	%
Operating Temperature	Power derating (above85°C, see Figure 5)	-40	--	85	°C
Storage Temperature		-55	--	125	
Temp. rise at full load	Ta=25°C	--	25	--	
Lead Temperature	1.5mm from case for 10 seconds	--	--	300	
Cooling		Free air convection			

## EMC SPECIFICATIONS

EMI	CE	CISPR22/EN55022 CLASS A(Without External Circuit)/ CLASS B (Recommended Circuit Refer to Figure1-② or Figure 3)			
	RE	CISPR22/EN55022 CLASS A(Without External Circuit)/ CLASS B(Recommended Circuit Refer to Figure1-② or Figure 3)			
EMS	ESD	IEC/EN61000-4-2	Contact $\pm 4\text{KV}$ / Air $\pm 8\text{KV}$	perf. Criteria B	
	RS	IEC/EN61000-4-3	10V/m	perf. Criteria A	
	EFT	IEC/EN61000-4-4	$\pm 2\text{KV}$	(Recommended Circuit Refer to Figure1-①)	perf. Criteria B
		IEC/EN61000-4-4	$\pm 4\text{KV}$	(Recommended Circuit Refer to Figure 3)	perf. Criteria B
	Surge	IEC/EN61000-4-5	$\pm 2\text{KV}$	(Recommended Circuit Refer to Figure1-① or Figure 3)	perf. Criteria B
	CS	IEC/EN61000-4-6	3 Vr.m.s		perf. Criteria A
	Voltage dips, short and interruptions immunity	IEC/EN61000-4-29	0%-70%		perf. Criteria B

## EMC RECOMMENDED CIRCUIT

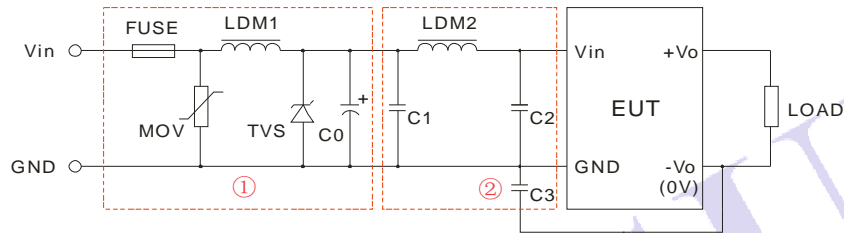

(Figure1)

Recommended external circuit parameters:

Model	Vin:5V	Vin:12V	Vin:24V	Vin:48V
FUSE	Choose according to practical input current			
MOV	--	--	S14K35	S14K60
LDM1	--	--	56 $\mu\text{H}$	
TVS	SMCJ13A	SMCJ28A	SMCJ48A	SMCJ90A
C0	680 $\mu\text{F}/16\text{V}$	680 $\mu\text{F}/25\text{V}$	330 $\mu\text{F}/50\text{V}$	330 $\mu\text{F}/100\text{V}$
C1	4.7 $\mu\text{F}/50\text{V}$			4.7 $\mu\text{F}/100\text{V}$
LDM2	12 $\mu\text{H}$			
C2	4.7 $\mu\text{F}/50\text{V}$			4.7 $\mu\text{F}/100\text{V}$
C3	1nF/2KV			

Note: 1. In Figure 1, part ① is EMS Recommended external circuit, part ② is EMI recommended external circuit. Choose according to requirements;  
2. If there is no recommended parameters, the model no require the external component.

## EMC RECOMMENDED CIRCUIT PCB LAYOUT

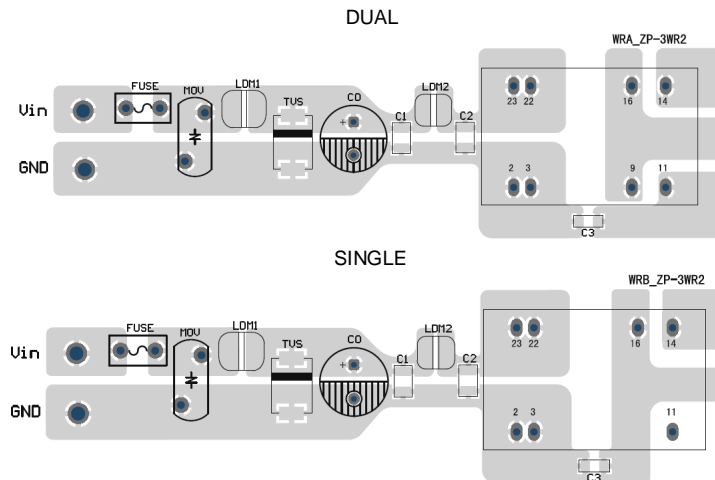

(Figure 2)

Note: The space between input and output GND (C3) must  $\geq 2\text{mm}$ .

## EMC MODULE APPLICATION CIRCUIT

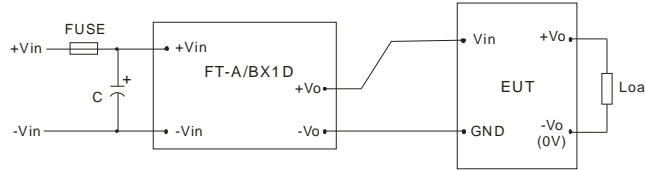

Nominal Input Voltage < 48V, C ≥ 330uF/50V  
 Nominal Input Voltage = 48V, C ≥ 330uF/100V  
 FT-A/BX1D is MORN SUN's EFT suppressor  
 (Figure 3)

## EMC MODULE RECOMMENDED CIRCUIT PCB LAYOUT

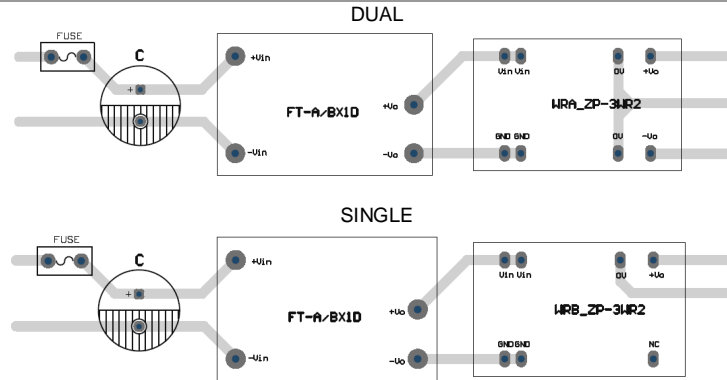

(Figure 4)

## EMI TEST WAVEFORM (RECOMMENDED CIRCUIT REFER TO FIGURE 1-②)

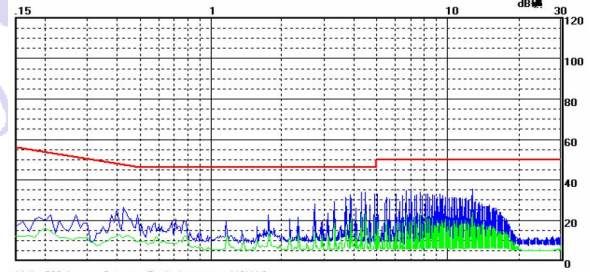
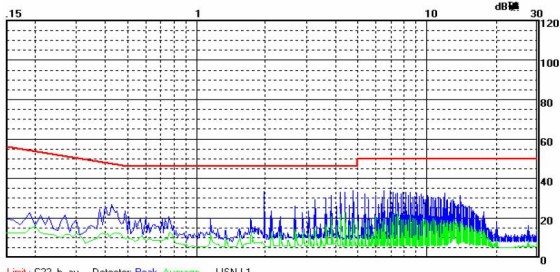

## PRODUCT TYPICAL PERFORMANCE CURVE

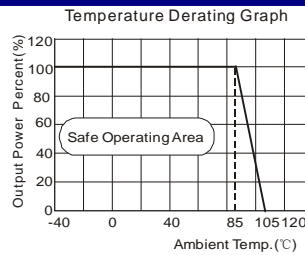

(Figure 5)

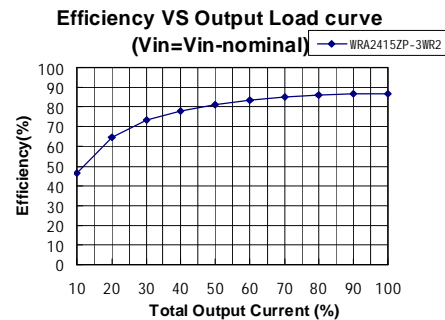
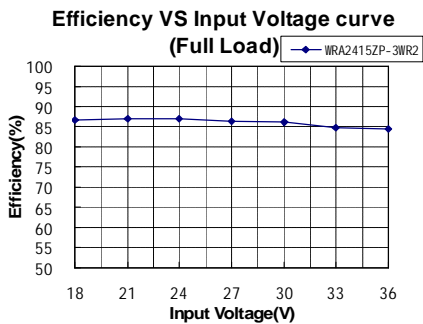

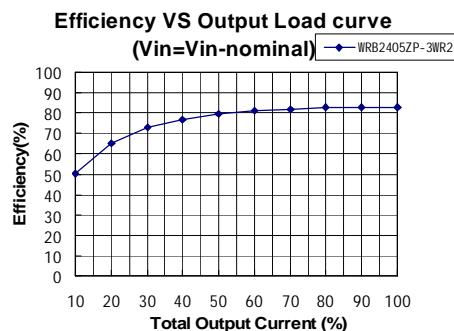
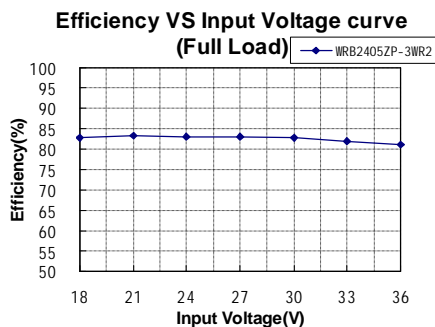

## MECHANICAL DIMENSIONS, RECOMMENDED FOOTPRINT & PACKAGING

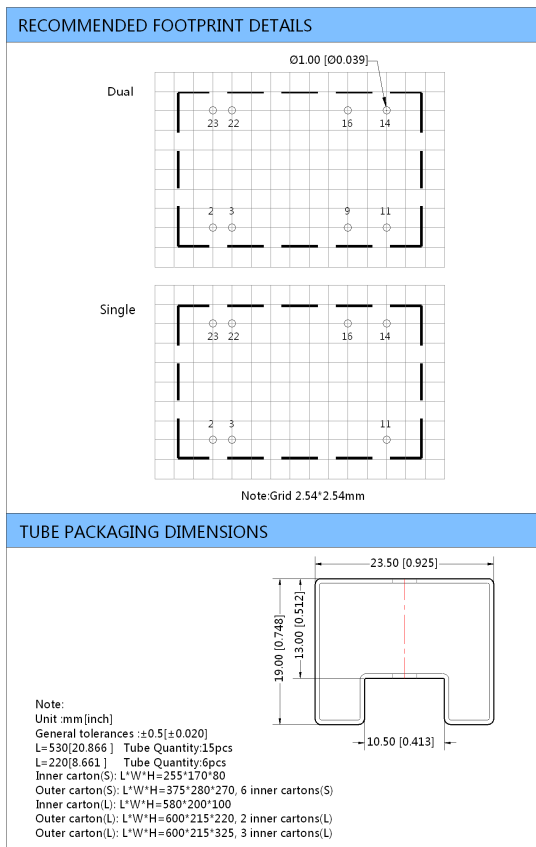
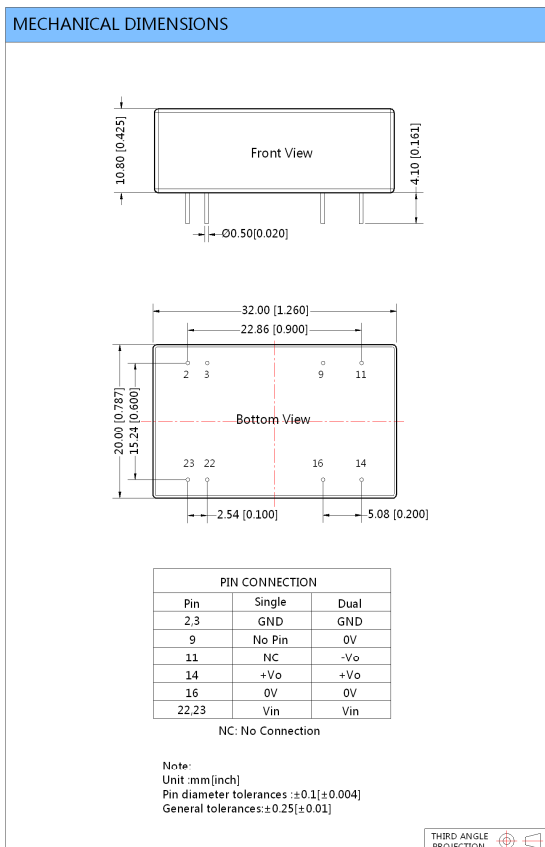

## TEST CONFIGURATIONS

### Input Reflected-Ripple Current Test Setup

Input reflected-ripple current is measured with an inductor  $L_{in}$  and Capacitor  $C_{in}$  to simulate the source impedance.

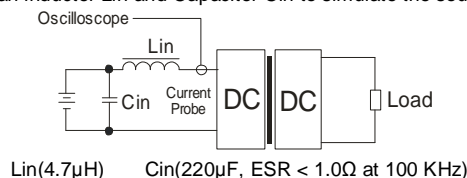

## DESIGN CONSIDERATIONS

### 1) Requirement on output load

To ensure this module can operate efficiently and reliably, during operation, the minimum output load could not be less than 5% of the full load, otherwise ripple may increase dramatically. If the actual output power is very small, please connect a resistor with proper resistance at the output end in parallel to increase the load, suppose to use the resistance of 5% rated power, or use our company's products with a lower rated output power.

## 2) Recommended circuit

All the WRA\_ZP-3WR2 & WRB\_ZP-3WR2 Series have been tested according to the following recommended test circuit before leaving the factory (See Figure 6).

If you want to further decrease the input/output ripple, you can increase a capacitance-values properly or choose capacitors with low ESR. However, the capacitance of the output filter capacitor must be proper. If the capacitance is too big, a startup problem might arise. For every channel of output, provided the safe and reliable operation is ensured, the greatest capacitance of its filter capacitor must be less than the Max. Capacitive Load.

General: Cin: 5V&12V 100 $\mu$ F  
24V&48V 10 $\mu$ F~47 $\mu$ F  
Cout: 10 $\mu$ F/100mA

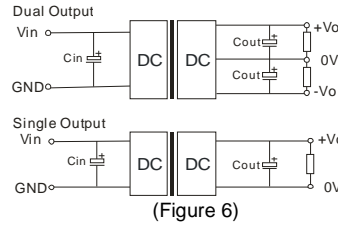

(Figure 6)

## 3) Input current

When it is used in unregulated power supply, be sure that the fluctuating range of the power supply and the rippled voltage do not exceed the module standard. Input current of power supply should afford the flash startup average current of this kind of DC/DC module (Figure 7).

General: Vin:5V lave =1400mA  
Vin:12V lave =620mA  
Vin:24V lave =310mA  
Vin:48V lave =150mA

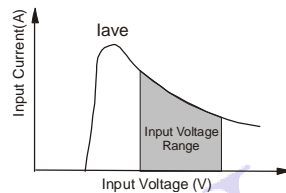

(Figure 7)

**4) It is not recommended to increase the output power capability by connecting two or more converters in parallel. The product is not hot-swappable**

Note:

1. Min. load shouldn't be less than 5%, otherwise ripple maybe increased dramatically. If the product operates under min. load, it may not be guaranteed to meet all specifications listed. Operation under minimum load will not damage the converter.
2. Recommended Dual output models unbalanced load is  $\leq \pm 5\%$ , if the product operates  $> \pm 5\%$ , it may not be guaranteed to meet all specifications listed. Please contact our technical support for more details.
3. All specifications measured at  $T_a = 25^\circ\text{C}$ , humidity  $< 75\%$ , nominal input voltage and rated output load unless otherwise specified.
4. Max. Capacitive Load is tested at input voltage range and full load.
5. In this datasheet, all test methods are based on our corporate standards.
6. All characteristics are for listed models, and non-standard models may perform differently. Please contact our technical support for more details.
7. Please contact our technical support for any specific requirement.
8. Specifications of this product are subject to changes without prior notice.

## **MORNSUN Science & Technology Co.,Ltd.**

Address: No. 5, Kehui St. 1, Kehui development center, Science Ave., Guangzhou Science City, Luogang district, Guangzhou, P.R.China.

Tel: 86-20-38601850

Fax: 86-20-38601272

E-mail: [info@mornsun.cn](mailto:info@mornsun.cn)

[Http://www.mornsun-power.com](http://www.mornsun-power.com)