

**Kingtronics**®**1N4148W**Silicon Epitaxial Planar  
Switching Diode**FEATURES**

SOD-123 package

Fast switching

These diodes are also available in other case style including the DO-35 case with the type designation 1N4148, the Mini MELF case with the type designation LL4148 and the Micro MELF case with the type designation MCL4148.

**PINNING**

PIN	DESCRIPTION
1	Cathode
2	Anode

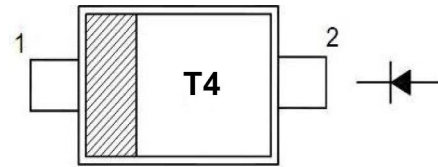

Top View

Marking Code: " T4"

Simplified outline SOD-123 and symbol

**Absolute Maximum Ratings (Ta = 25°C)**

PARAMETER	SYMBOL	VALUE	UNIT
Peak Reverse Voltage	$V_{RM}$	100	V
Reverse Voltage	$V_R$	75	V
Average Rectified Forward Current	$I_F (AV)$	150	mA
Non-repetitive Peak Forward Surge Current at $t = 1 \mu s$	$I_{FSM}$	2	A
Power Dissipation	$P_{tot}$	400	mW
Thermal Resistance from Junction to Ambient Air	$R_{\theta JA}$	312	°C/W
Junction Temperature	$T_j$	150	°C
Storage Temperature Range	$T_{stg}$	- 65 to + 150	°C

**Electrical Characteristics (Ta = 25°C)**

PARAMETER	SYMBOL	MAX.	UNIT
Forward Voltage at $I_F = 10 \text{ mA}$	$V_F$	1	V
Reverse Current	$I_R$	25	nA
at $V_R = 20 \text{ V}$		5	$\mu A$
at $V_R = 75 \text{ V}$		50	$\mu A$
at $V_R = 20 \text{ V}, T_J = 150^\circ C$			
Total Capacitance at $V_R = 0 \text{ V}, f = 1 \text{ MHz}$	$C_{tot}$	4	pF
Reverse Recovery Time at $I_F = 10 \text{ mA}$ to $I_R = 1 \text{ mA}, V_R = 6 \text{ V}, R_L = 100 \Omega$	$t_{rr}$	4	ns

**Kingtronics**® International CompanyWebsite: [www.kingtronics.com](http://www.kingtronics.com) Email: [info@kingtronics.com](mailto:info@kingtronics.com) Tel: (852) 8106 7033 Fax: (852) 8106 7099

# Kingtronics®

## 1N4148W

Silicon Epitaxial Planar  
Switching Diode

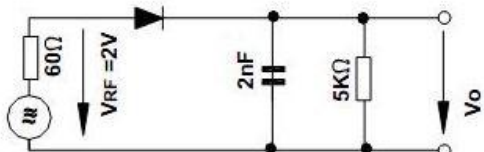

Rectification Efficiency Measurement Circuit

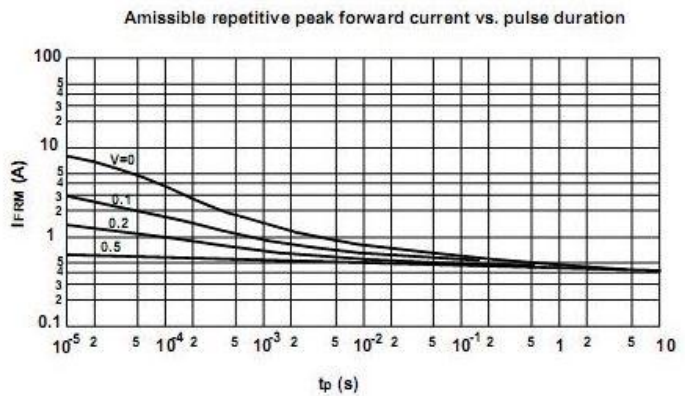
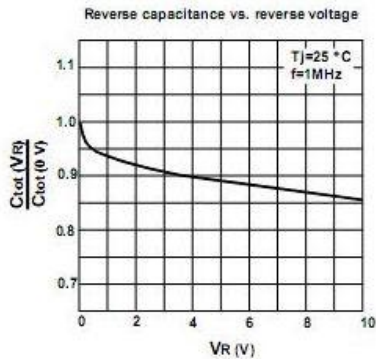
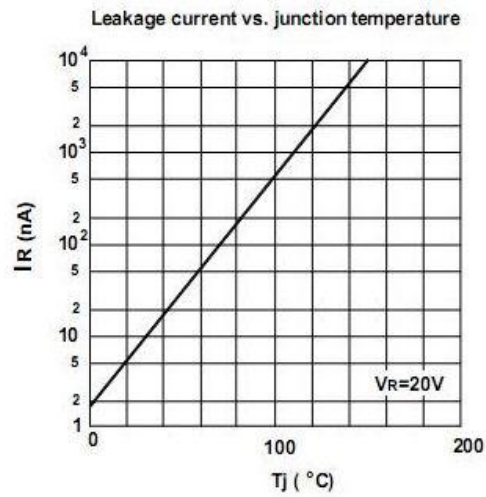
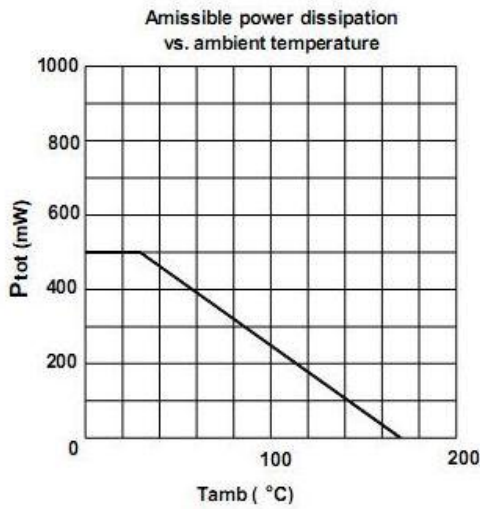
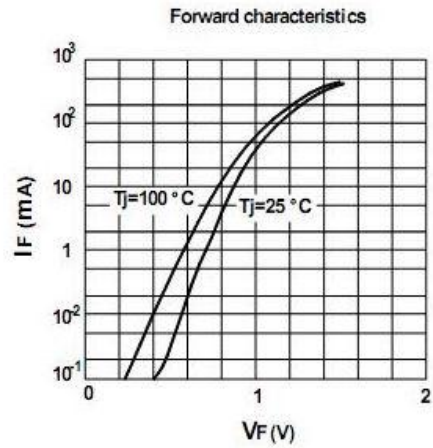

**Kingtronics® International Company**

# Kingtronics®

## 1N4148W

Silicon Epitaxial Planar  
Switching Diode

### PACKAGE OUTLINE

Plastic surface mounted package; 2 leads

SOD-123

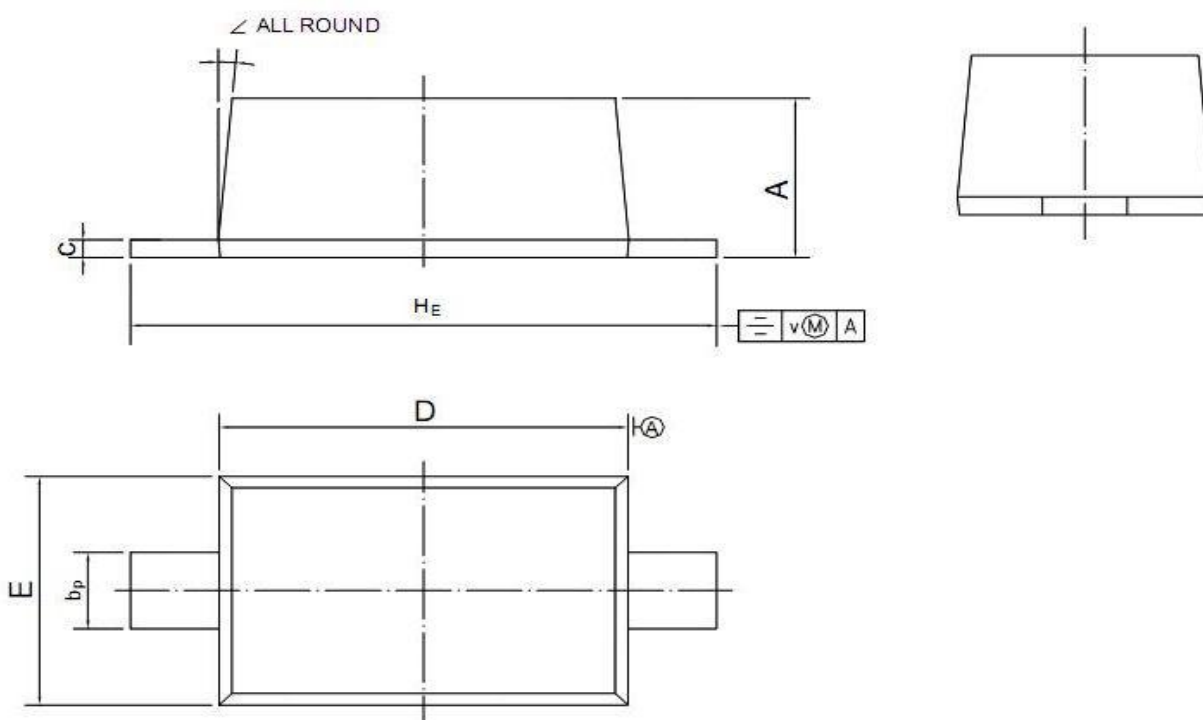

UNIT	A	$b_p$	c	D	E	$H_E$	v	∠
mm	1.15 1.05	0.6 0.5	0.135 0.100	2.7 2.6	1.65 1.55	3.85 3.55	0.2	5°

Note: Specifications are subject to change without notice.

**Kingtronics® International Company**

Website: [www.kingtronics.com](http://www.kingtronics.com) Email: [info@kingtronics.com](mailto:info@kingtronics.com) Tel: (852) 8106 7033 Fax: (852) 8106 7099