

## MBR0520-MBR0580

Schottky Barrier Diode  
SOD-123 Plastic-Encapsulate Diodes

### FEATURES

Lead Free Finish/RoHS Compliant  
Extremely Low Thermal Resistance  
For Surface Mount Application and High Current Capability

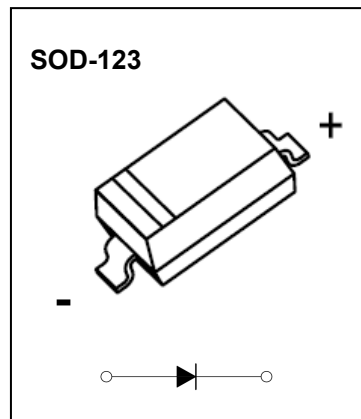

### MARKING:

MBR0520:R2	MBR0530:R3	MBR0540:R4	MBR0560:R6	MBR0580:R8

The marking bar indicates the cathode  
Solid dot = Green molding compound device, if none,  
the normal device.

### Maximum Ratings @ $T_a=25^{\circ}\text{C}$

Parameter	Symbol	MBR	MBR	MBR	MBR	MBR	Unit
		0520	0530	0540	0560	0580	
<b>Maximum recurrent peak reverse voltage</b>	$V_{RRM}$	20	30	40	60	80	V
<b>Maximum RMS voltage</b>	$V_{RMS}$	14	21	28	42	56	
<b>Mean rectifying current</b>	$I_O$	0.5					A
<b>Non-repetitive Peak forward surge current @<math>t=8.3\text{ms}</math></b>	$I_{FSM}$	5.5					A
<b>Power Dissipation</b>	$P_D$	410					mW
<b>Thermal Resistance Junction to Ambient</b>	$R_{\theta JA}$	244					$^{\circ}\text{C/W}$
<b>Junction temperature</b>	$T_j$	125					$^{\circ}\text{C}$
<b>Storage temperature</b>	$T_{stg}$	-55~+150					$^{\circ}\text{C}$

## ELECTRICAL CHARACTERISTICS

$T_a=25\text{ }^\circ\text{C}$  unless otherwise specified

Parameter	Symbol	Min.	Typ.	Max.	Unit	Conditions
Forward voltage MBR0520 MBR0530 MBR0540 MBR0560 MBR0580	$V_F$			0.45 0.55 0.55 0.70 0.80	V	$I_F=500\text{mA}$
Reverse current MBR0520 MBR0530 MBR0540 MBR0560 MBR0580	$I_R$			80	$\mu\text{A}$	$V_R=20\text{V}$ $V_R=30\text{V}$ $V_R=40\text{V}$ $V_R=60\text{V}$ $V_R=80\text{V}$
Capacitance between terminals	$C_T$		30		pF	$V_R=4\text{V}$ , $f=1\text{MHZ}$

## Typical Characteristics

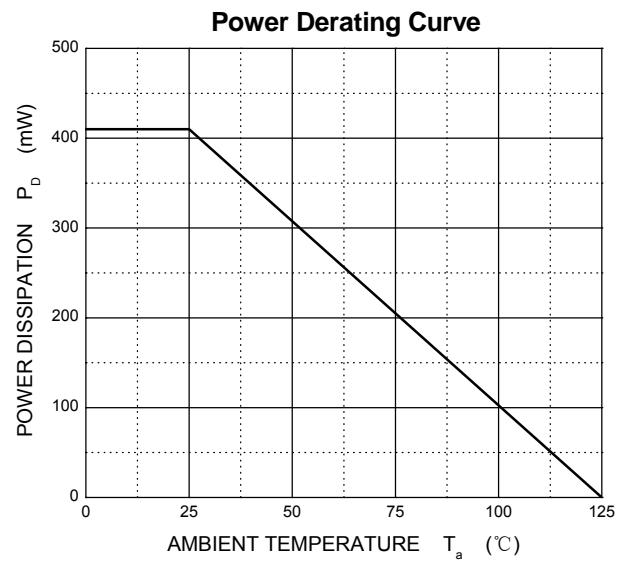
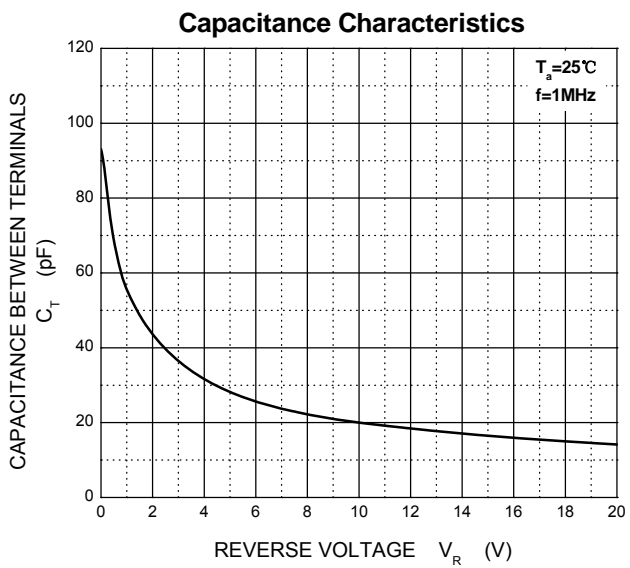
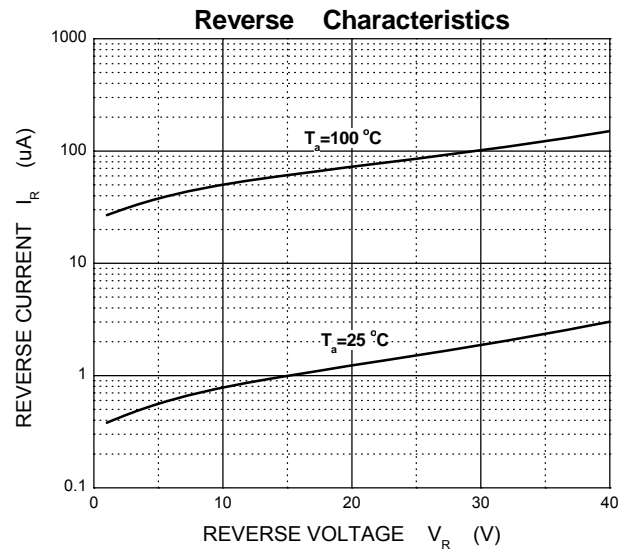
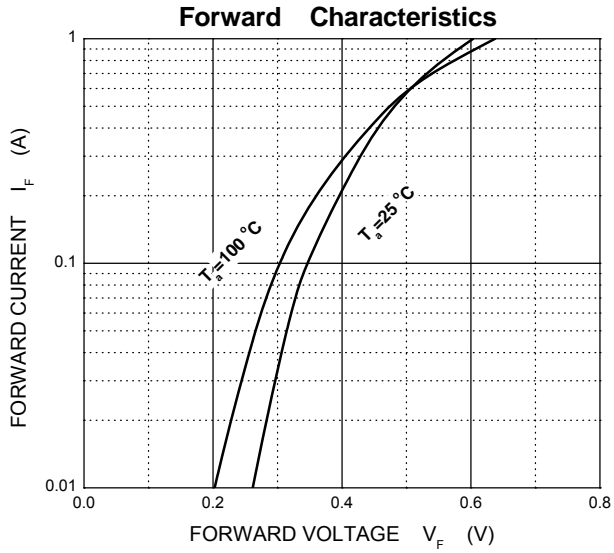

## SOD-123 Package Outline Dimensions

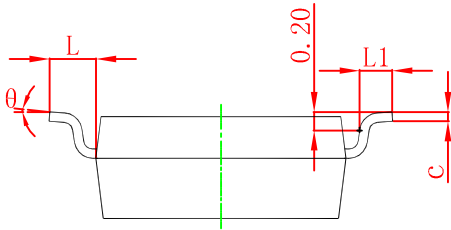
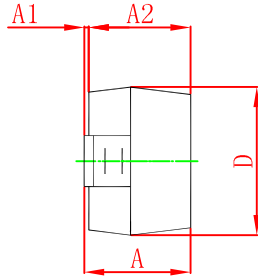
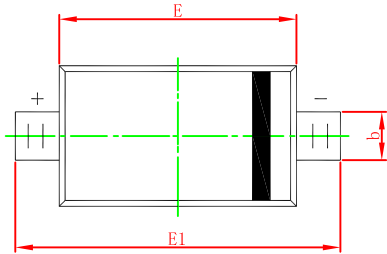

Symbol	Dimensions In Millimeters		Dimensions In Inches	
	Min	Max	Min	Max
A	1.050	1.250	0.041	0.049
A1	0.000	0.100	0.000	0.004
A2	1.050	1.150	0.041	0.045
b	0.450	0.650	0.018	0.026
c	0.080	0.150	0.003	0.006
D	1.500	1.700	0.059	0.067
E	2.600	2.800	0.102	0.110
E1	3.550	3.850	0.140	0.152
L	0.500 REF		0.020 REF	
L1	0.250	0.450	0.010	0.018
$\theta$	0°	8°	0°	8°