

Infrared Emitter (850 nm)

Version 1.3

SFH 4356



Features:

- Wavelength 850nm
- Short switching times
- Good spectral match to silicon photodetectors
- package similar to SFH 309

Applications

- IR remote control
- Sensor technology
- Discrete optocouplers
- Discrete interrupters

Notes

Depending on the mode of operation, these devices emit highly concentrated non visible infrared light which can be hazardous to the human eye. Products which incorporate these devices have to follow the safety precautions given in IEC 60825-1 and IEC 62471.

Ordering Information

Type:	Radiant Intensity I_e [mW/sr] $I_F= 100 \text{ mA}, t_p= 20 \text{ ms}$	Ordering Code
SFH 4356	90 (≥ 40)	Q65111A6136
SFH 4356-UV	40 ... 125	Q65111A8863

Note: measured at a solid angle of $\Omega = 0.01 \text{ sr}$

Maximum Ratings ($T_A = 25\text{ °C}$)

Parameter	Symbol	Values	Unit
Operation and storage temperature range	$T_{op}; T_{stg}$	-40 ... 100	°C
Reverse voltage	V_R	5	V
Forward current	I_F	100	mA
Surge current ($t_p \leq 200\ \mu\text{s}$, $D = 0$)	I_{FSM}	1	A
Power consumption	P_{tot}	200	mW
ESD withstand voltage (acc. to ANSI/ ESDA/ JEDEC JS-001 - HBM)	V_{ESD}	2	kV
Thermal resistance junction - ambient ^{1) page 9}	R_{thJA}	350	K / W
Thermal resistance junction - soldering point	R_{thJS}	150	K / W

Characteristics ($T_A = 25\text{ °C}$)

Parameter	Symbol	Values	Unit
Peak wavelength ($I_F = 100\text{ mA}$, $t_p = 20\text{ ms}$)	(typ) λ_{peak}	860	nm
Centroid wavelength ($I_F = 100\text{ mA}$, $t_p = 20\text{ ms}$)	(typ) $\lambda_{centroid}$	850	nm
Spectral bandwidth at 50% of I_{max} ($I_F = 100\text{ mA}$, $t_p = 20\text{ ms}$)	(typ) $\Delta\lambda$	30	nm
Half angle	(typ) φ	± 20	°
Dimensions of active chip area	(typ) L x W	0.3 x 0.3	mm x mm
Rise and fall time of I_e (10% and 90% of $I_{e\ max}$) ($I_F = 100\text{ mA}$, $R_L = 50\ \Omega$)	(typ) t_r, t_f	12	ns
Forward voltage ($I_F = 100\text{ mA}$, $t_p = 20\text{ ms}$)	(typ (max)) V_F	1.7 (≤ 2)	V
Forward voltage ($I_F = 1\text{ A}$, $t_p = 100\ \mu\text{s}$)	(typ (max)) V_F	3.6 (≤ 4.6)	V
Reverse current ($V_R = 5\text{ V}$)	I_R	not designed for reverse operation	μA
Total radiant flux ($I_F = 100\text{ mA}$, $t_p = 20\text{ ms}$)	(typ) Φ_e	80	mW

Parameter		Symbol	Values	Unit
Temperature coefficient of I_e or Φ_e ($I_F = 100 \text{ mA}$, $t_p = 20 \text{ ms}$)	(typ)	TC_I	-0.3	% / K
Temperature coefficient of V_F ($I_F = 100 \text{ mA}$, $t_p = 20 \text{ ms}$)	(typ)	TC_V	-0.6	mV / K
Temperature coefficient of wavelength ($I_F = 100 \text{ mA}$, $t_p = 20 \text{ ms}$)	(typ)	TC_λ	0.3	nm / K

Grouping ($T_A = 25 \text{ }^\circ\text{C}$)

Group	Min Radiant Intensity	Max Radiant Intensity	Typ Radiant Intensity
	$I_F = 100 \text{ mA}$, $t_p = 20 \text{ ms}$ $I_{e, \text{min}}$ [mW / sr]	$I_F = 100 \text{ mA}$, $t_p = 20 \text{ ms}$ $I_{e, \text{max}}$ [mW / sr]	$I_F = 1 \text{ A}$, $t_p = 100 \text{ } \mu\text{s}$ $I_{e, \text{typ}}$ [mW / sr]
SFH 4356-U	40	80	255
SFH 4356-V	63	125	395
SFH 4356-AW	100	200	630
SFH 4356-BW	160	320	1000

Note: Measured at a solid angle of $\Omega = 0.01 \text{ sr}$

Only one group in one packing unit (variation lower 2:1).

Relative Spectral Emission ^{2) page 9}

$I_{rel} = f(\lambda), T_A = 25^\circ\text{C}$

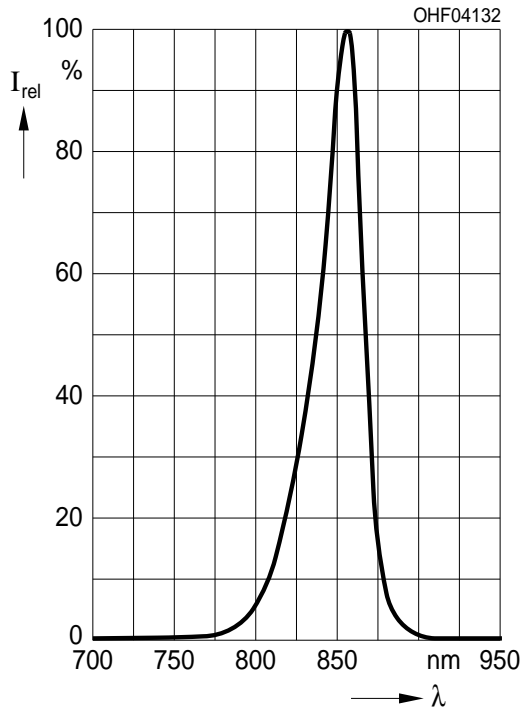

Radiant Intensity ^{2) page 9}

$I_e / I_e(100 \text{ mA}) = f(I_F), \text{ single pulse, } t_p = 100 \mu\text{s}, T_A = 25^\circ\text{C}$

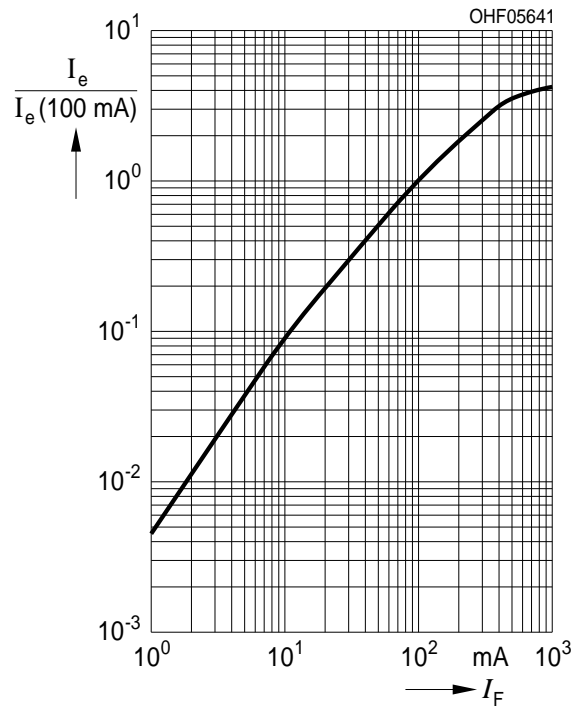

Max. Permissible Forward Current

$I_{F, max} = f(T_A), R_{thJA} = 350 \text{ K/W}$

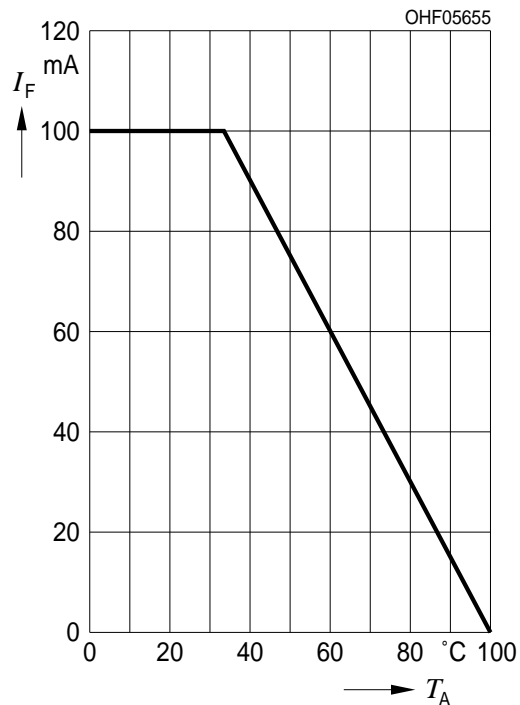

Forward Current ^{2) page 9}

$I_F = f(V_F), \text{ single pulse, } t_p = 100 \mu\text{s}, T_A = 25^\circ\text{C}$

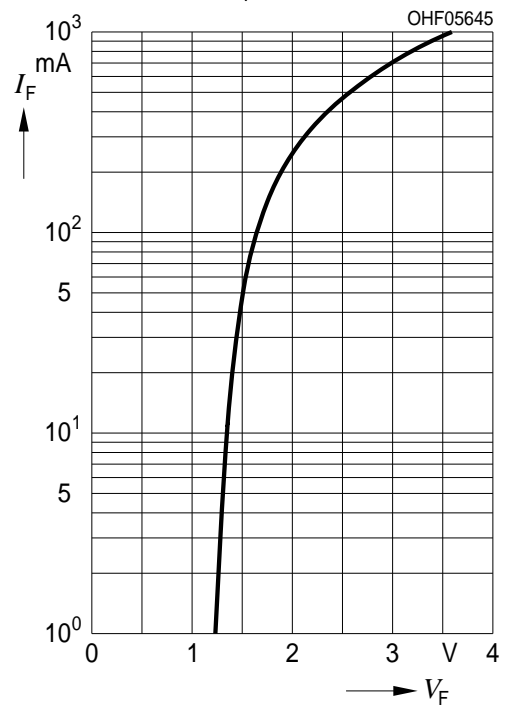

Permissible Pulse Handling Capability

$I_F = f(t_p)$, $T_A = 25\text{ °C}$, duty cycle $D = \text{parameter}$

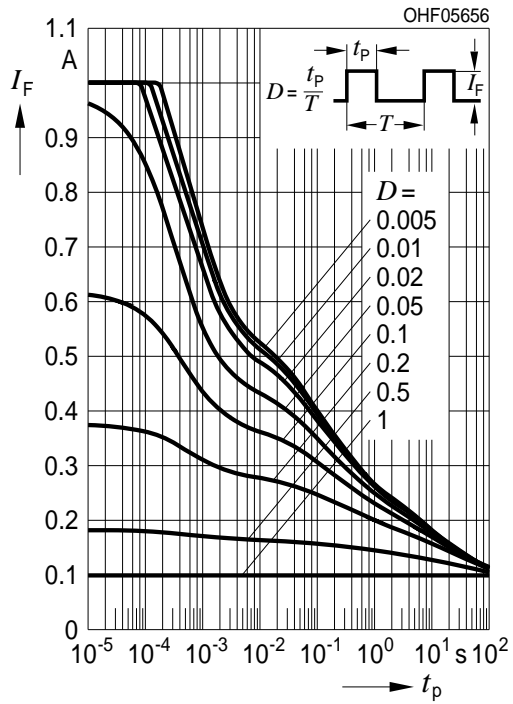

Permissible Pulse Handling Capability

$I_F = f(t_p)$, $T_A = 85\text{ °C}$, duty cycle $D = \text{parameter}$

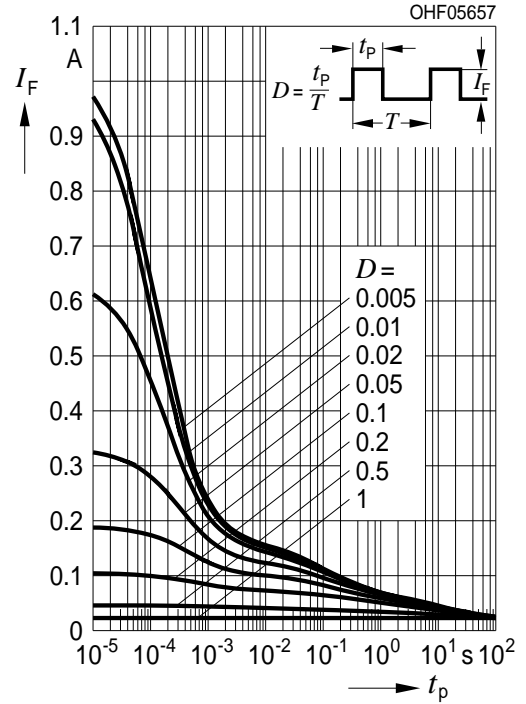

Radiation Characteristics ^{2) page 9}

$I_{rel} = f(\phi)$, $T_A = 25\text{ °C}$

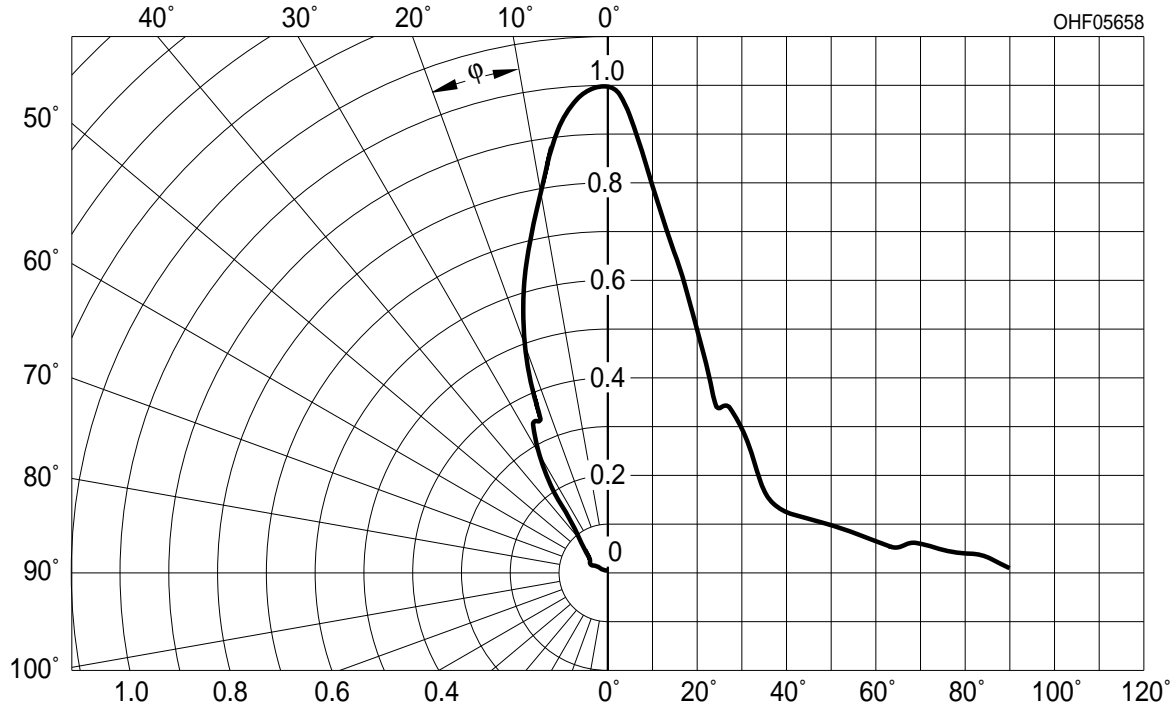

Package Outline

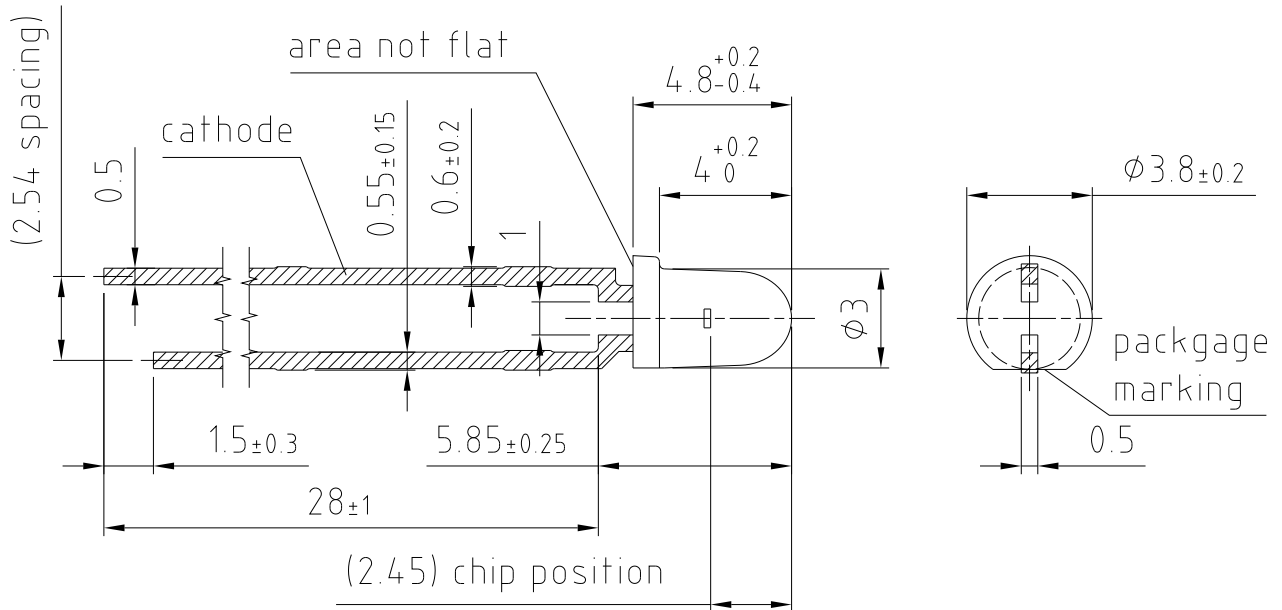

general tolerance ± 0.1

lead finish Sn 

Dimensions in mm.

Package

3mm Radial (T 1), Epoxy, black

Approximate Weight:

0.2 g

Note

Packing information is available on the internet (online product catalog).

C63062-A4232-A1... -04

Recommended Solder Pad



E062.3010.188-01

Dimensions in mm.

Note:

pad 1: cathode

TTW Soldering

IEC-61760-1 TTW

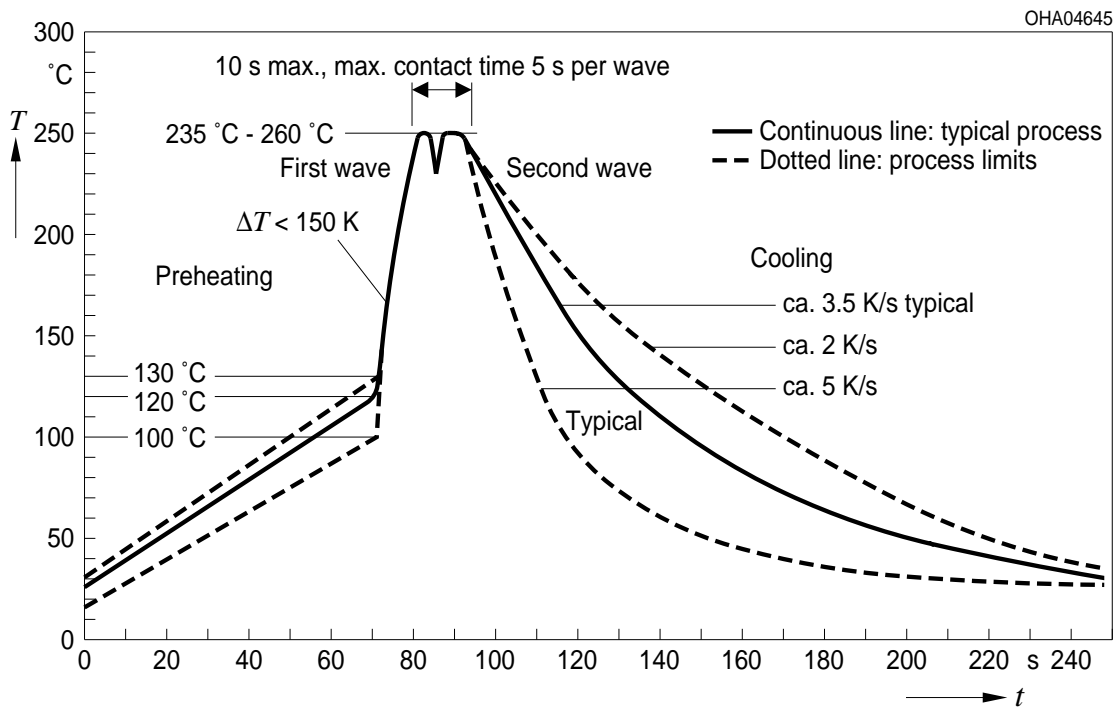

Disclaimer

Language english will prevail in case of any discrepancies or deviations between the two language wordings.

Attention please!

The information describes the type of component and shall not be considered as assured characteristics.

Terms of delivery and rights to change design reserved. Due to technical requirements components may contain dangerous substances.

For information on the types in question please contact our Sales Organization.

If printed or downloaded, please find the latest version in the Internet.

Packing

Please use the recycling operators known to you. We can also help you – get in touch with your nearest sales office.

By agreement we will take packing material back, if it is sorted. You must bear the costs of transport. For packing material that is returned to us unsorted or which we are not obliged to accept, we shall have to invoice you for any costs incurred.

Components used in life-support devices or systems must be expressly authorized for such purpose!

Critical components* may only be used in life-support devices** or systems with the express written approval of OSRAM OS.

*) A critical component is a component used in a life-support device or system whose failure can reasonably be expected to cause the failure of that life-support device or system, or to affect its safety or the effectiveness of that device or system.

**) Life support devices or systems are intended (a) to be implanted in the human body, or (b) to support and/or maintain and sustain human life. If they fail, it is reasonable to assume that the health and the life of the user may be endangered.

Glossary

- 1) **Thermal resistance:** junction -ambient, mounted on PC-board (FR4), pads size 16 mm² each
- 2) **Typical Values:** Due to the special conditions of the manufacturing processes of LED, the typical data or calculated correlations of technical parameters can only reflect statistical figures. These do not necessarily correspond to the actual parameters of each single product, which could differ from the typical data and calculated correlations or the typical characteristic line. If requested, e.g. because of technical improvements, these typ. data will be changed without any further notice.

Published by OSRAM Opto Semiconductors GmbH
Leibnizstraße 4, D-93055 Regensburg
www.osram-os.com © All Rights Reserved.

EU RoHS and China RoHS compliant product



此产品符合欧盟 RoHS 指令的要求；
按照中国的相关法规和标准，不含有毒有害物质或元素。