



YETDA INDUSTRY LTD.

1W High Power LED(Star)Lambertian WW030F-S 4500K

1W High Power with Nature White Color

Encapsulated with Water Clear Lens Package

Absolute Maximum Ratings :

Parameter	Maximum Rating	Unit
Peak Forward Current	400	mA
Operating Temperature Range	-30°C to +60°C	
Storage Temperature Range	-40°C to +90°C	
Lead Soldering Temperature	250°C for 5 seconds 1.6mm(0.063 inch) from body	

Electro-Optical Characteristics (Ta = 25°C)

Parameter Radiant	Test Condition	Symbol	Min.	Typ.	Max.	Unit
Forward Voltage	IF = 350mA	Vf	3.0		3.4	V
Reverse Current	VR = 5V	Ir	0		1	uA
Luminous Intensity	IF = 350mA	Iv	90		130	lm
Color Temperature	IF = 350mA	λ d		4500		nm
Viewing Angle	IF = 350mA	2 θ1/2		140		deg

Package

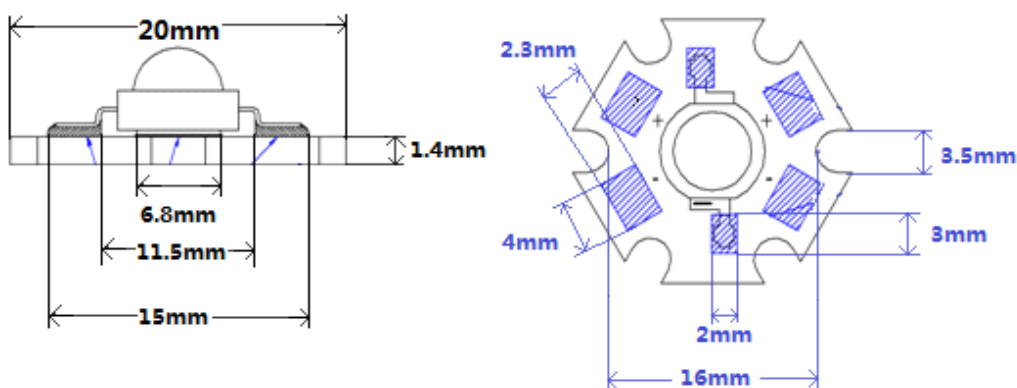

Unit: mm

13JUNE20J



YETDA INDUSTRY LTD.

Electrical/Optical Characteristics Curves

LED emission spectrum

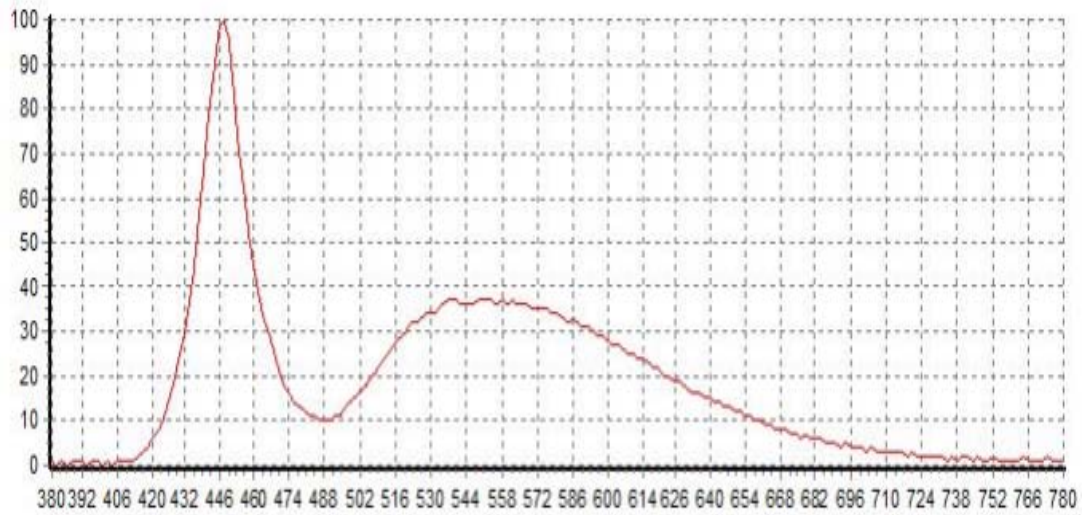

Typical radiation distribution

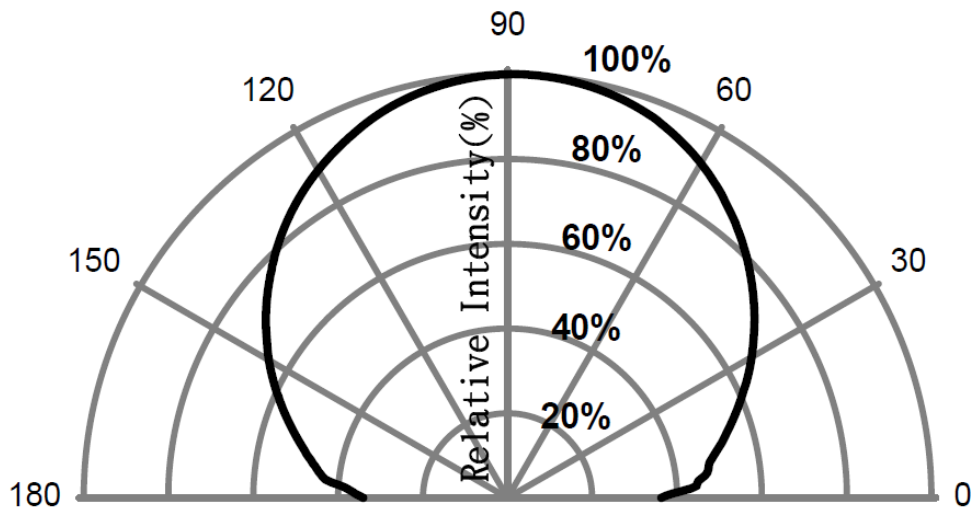



YETDA INDUSTRY LTD.

Electrical parameters characteristic

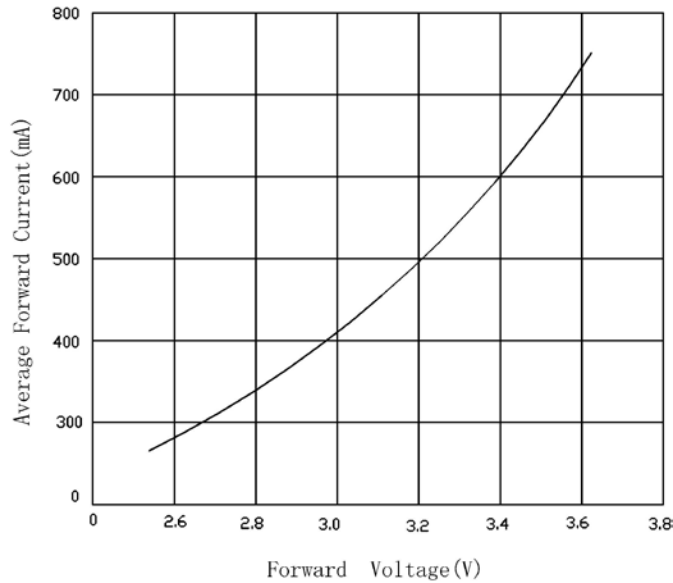

Forward Current

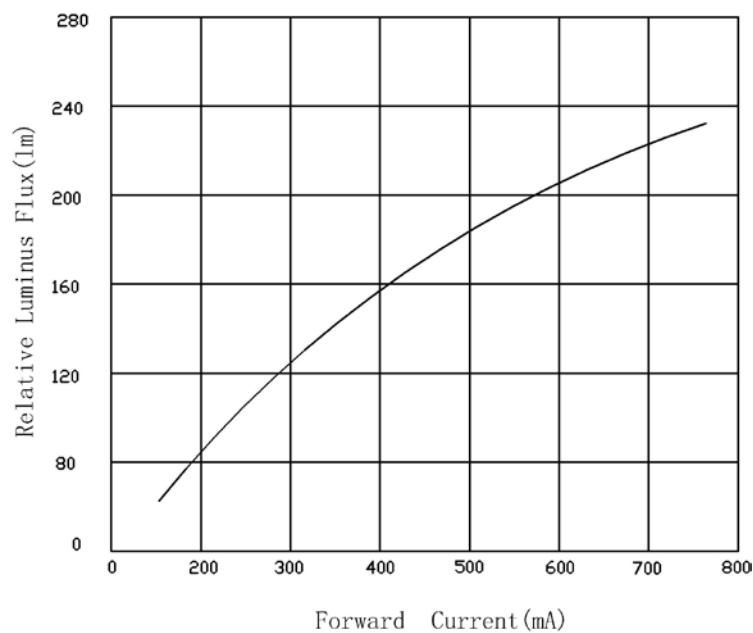

*IFP Conditions : Pulse Width \leq 10msec duty \leq 1/10

* All high power emitter LED products mounted on aluminum metal-core printed circuit board, can be lighted directly, but we do not recommend lighting the high power products for more than 5 seconds without a appropriate heat dissipation equipment.

* Re-flow, wave peak and soak- stannum soldering etc.is not suitable for this products.

* Suggest to solder it by professional high power LED soldering machine.

* Can use invariable-temperature searing-iron with soldering condition \leq 260 degree less than 3 seconds.