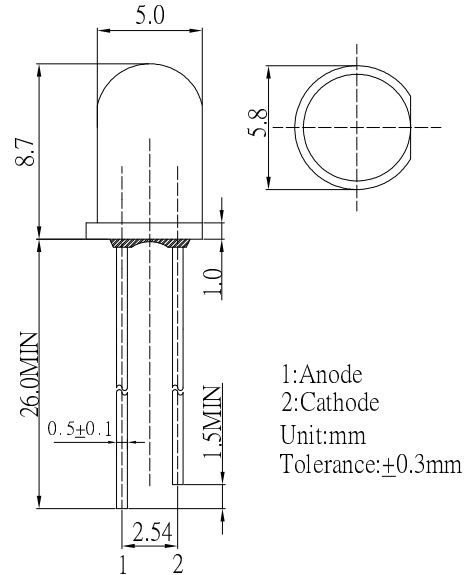

■Features

- Green Diffused Type
- 5mm Standard Directivity
- Superior Weather-resistance
- RoHS Compliant

■Applications

- Toys
- Games
- Audio
- Christmas Light

■Outline Dimension

■Absolute Maximum Rating
(Ta=25°C)

Item	Symbol	Value	Unit
DC Forward Current	I_F	30	mA
Pulse Forward Current*	I_{FP}	100	mA
Reverse Voltage	V_R	5	V
Power Dissipation	P_D	72	mW
Operating Temperature	T_{opr}	-30 ~ +85	°C
Storage Temperature	T_{stg}	-40 ~ +100	°C
Lead Soldering Temperature	T_{sol}	260°C/5sec	-

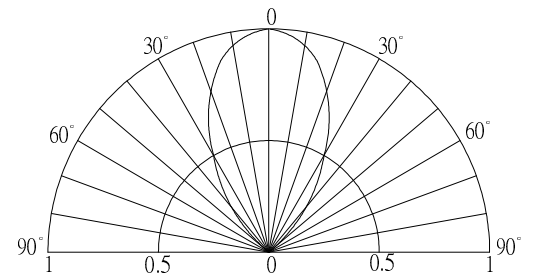
*Pulse width Max.10ms Duty ratio max 1/10

■Directivity

■Electrical -Optical Characteristics
(Ta=25°C)

Item	Symbol	Condition	Min	Typ	Max	Unit
DC Forward Voltage	V_F	$I_F=20mA$	1.8	2.0	2.4	V
DC Reverse Current	I_R	$V_R=5V$	-	-	10	μA
Domi. Wavelength	λ_D	$I_F=20mA$	630	635	640	nm
Luminous Intensity	I_v	$I_F=20mA$	45	68	-	mcd
50% Power Angle	$2\theta_{1/2}$	$I_F=20mA$	-	60	-	deg