

R080E

3W Power LED

Technical Datasheet

Features

- ☆ High Flux per LED
- ☆ Very long operating life(up to 100k hours)
- ☆ Available in White, Warm White, Green, Blue, Amber, Red-Orange and Red
- ☆ Lambertian or Collimated Radiation Pattern
- ☆ More Energy Efficient than Incandescent and most Halogen lamps
- ☆ Low Voltage DC operated
- ☆ Cool beam, safe to the touch
- ☆ Instant light (less than 100ns)
- ☆ No UV
- ☆ Superior ESD protection
- ☆ Soldering methods: IR reflow soldering and Hand soldering

Typical Applications

- ☆ Reading lights (car, bus, aircraft)
- ☆ Portable (flashlight, bicycle)
- ☆ Decorative
- ☆ Appliance
- ☆ Sign and Channel Letter
- ☆ Architectural Detail
- ☆ Cove Lighting
- ☆ Automotive Exterior (Stop-Tail-Turn, CHMSL, Mirror Side Repeat)
- ☆ LCD backlight

Mechanical Dimensions

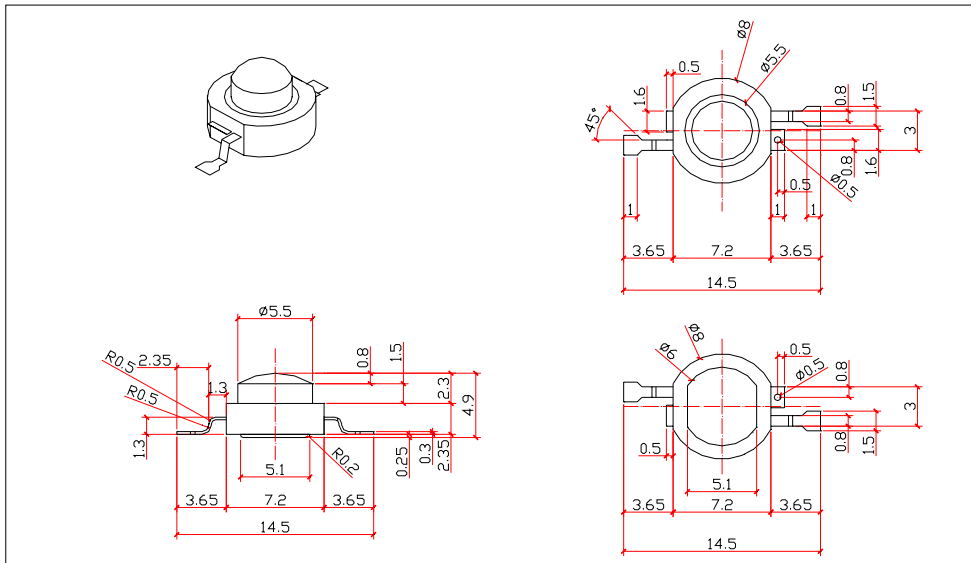

Notes:

1. Slots in aluminum-core PCB for M3 or #4 mounting screw.
2. Electrical interconnection pads labeled on the aluminum-core PCB with "+" and "-" to denote positive and negative, respectively. All positive pads are interconnected, as are all negative pads, allowing for flexibility in array interconnection.
3. Drawing not to scale.
4. All dimensions are in millimeters.

Part Number Matrix

Color	Emitter	Beam Pattern
Red	R080E	Bat Wing

Flux Characteristics at 700Ma, Junction Temperature, T_j=25°C

Color	Minimum Luminous Flux (lm)	Typical Luminous Flux (lm)	Beam Pattern
Red	56	80	Bat Wing

Optical Characteristics at 700Ma, Junction Temperature, T_j=25°C

Color	Dominant Wavelength λ_d			Spectral Half-width (nm) $\Delta\lambda_{1/2}$	Temperature Coefficient or Dominant Wavelength $\Delta\lambda_D/\Delta T_j$ (nm / °C)
	Peak Wavelength λ_p	Color Temperature(CCT)			
	Min.	Typ.	Max.		
Red	620.5nm	625nm	645nm	20	0.05

Optical Characteristics at 700Ma, Junction Temperature, Tj=25°C

(Continued)

Color	Beam Pattern	Total Included Angle $\phi_{0.9v}$ (degree)	Viewing Angle $2\theta_{1/2}$ (degree)	Typical Candela on Axis (cd)
Red		120	110	

Electrical Characteristics at 700Ma, Junction Temperature, Tj=25°C

Color	Forward Voltage Vf(V)			Dynamic Resistance(-)	Temperature Coefficient of Vf(Mv/) $\Delta Vf/\Delta Tj$	Thermal Resistance Junction to Board(°C/W)
	Min.	Typ.	Max.			
Red	2.10	2.40	3.30	2.4	-2	15

Absolute Maximum Ratings

Parameter	White/Warm White/Green/Blue	Amber/Red-Orange/Red
DC Forward Current (mA)	350	385
Peak Pulsed Forward Current (mA)	500	550
Average Forward Current (mA)	350	350
ESD Sensitivity	±16000V HBM	
LED Junction Temperature (°C)	135	120
Aluminum-core PCB Temperature(°C)	105	105
Storage & Operating Temperature(°C)	-40 to +105	-40 to +105
Soldering Temperature(°C)	260 for 5 seconds Max.	

Photometric Luminous Flux Bin Structure

Bin Code	Minimum Photometric Flux (lm)	Maximum Photometric Flux (lm)
F	2.9	3.8
G	3.8	4.9
H	4.9	5.3
J	5.3	8.2
K	8.2	10.7
L	10.7	13.9
M	13.9	18.1
N	18.1	23.5
P	23.5	30.6
Q	30.6	39.8
R	39.8	51.7
S	51.7	67.2
T	67.2	87.4
U	87.4	113.6
V	113.6	147.7

Color Bins for Red

Bin Code	Minimum Dominant Wavelength (nm)	Maximum Dominant Wavelength (nm)
2	613.5	620.5
4	620.5	631.0
5	631.0	645.0

Forward Voltage Bins

Bin Code	Minimum Forward Voltage (V)	Maximum Forward Voltage (V)
C	1.83	2.07
D	2.07	2.31
E	2.31	2.55
F	2.55	2.79
G	2.79	3.03
H	3.03	3.27
J	3.27	3.51
K	3.51	3.75
L	3.75	3.99
M	3.99	4.23
N	4.23	4.47
R	5.43	5.91
S	5.91	6.39
T	6.39	6.87
U	6.87	7.35
V	7.35	7.83
W	7.83	8.31

Wavelength Characteristics, $T_j=25^\circ\text{C}$

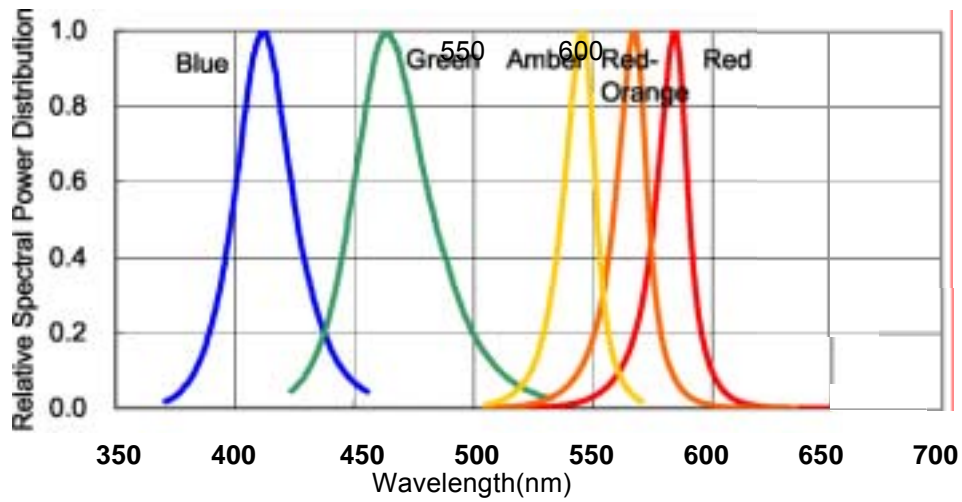

Figure 1a. Relative Intensity vs. Wavelength

White Color Spectrum

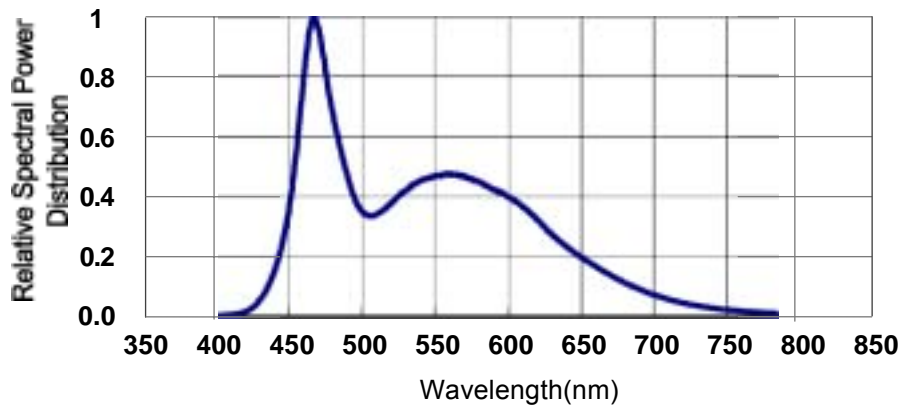

Figure 1 b. White Color Spectrum of Typical 5500K Part.

Light Output Characteristics

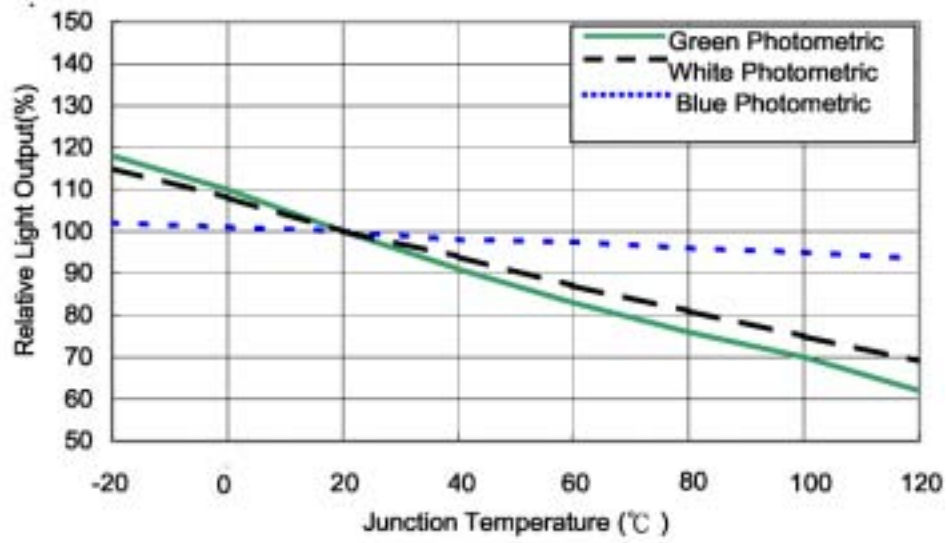

Figure 2a. Relative Light Output vs. Junction Temperature

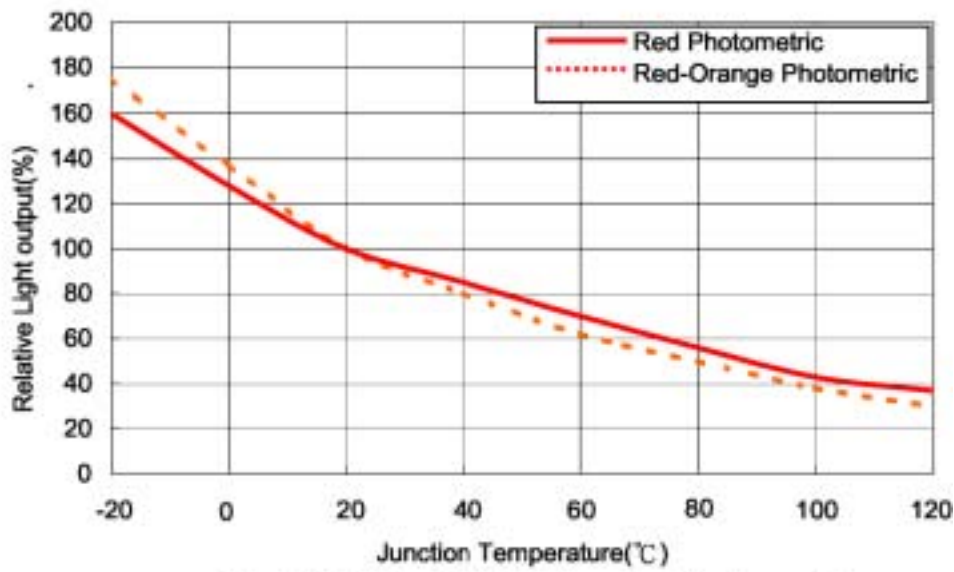

Figure 2b. Relative Light Output vs. Junction Temperature

Forward Current Characteristics. $T_i=25^\circ\text{C}$

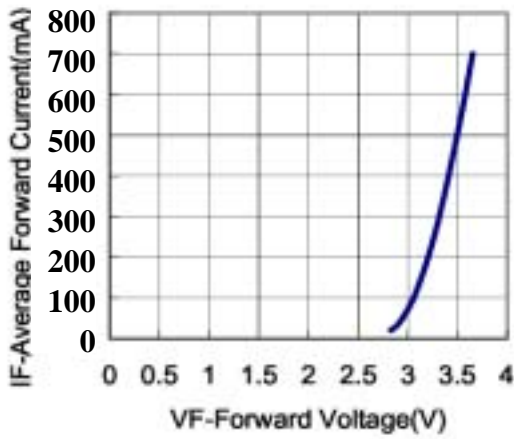

Fig 3a. Forward Voltage(V) Forward Voltage for White, Blue and Green.

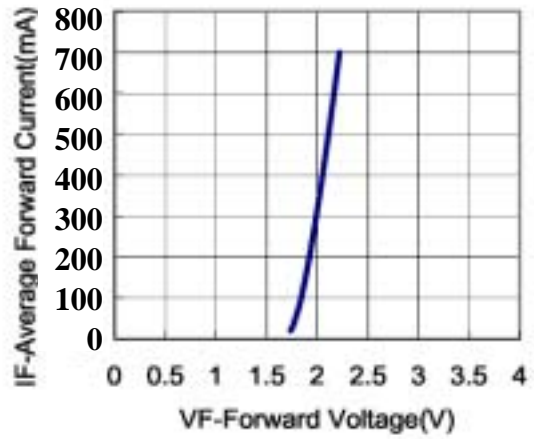

Fig 3b. Forward Current vs. Forward Voltage for Yellow and Red.

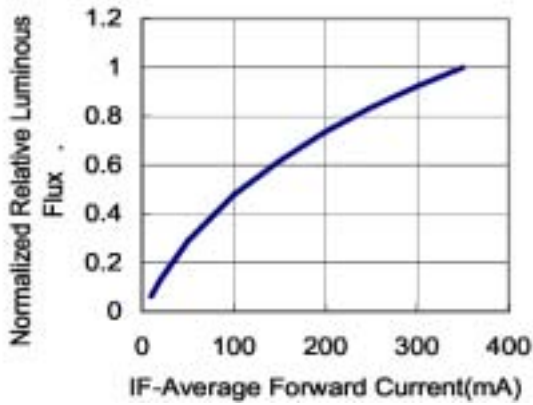

Fig 4a. Relative Luminous Flux vs. Forward Current for White, Blue and Green at $T_j=25^\circ\text{C}$ maintained.

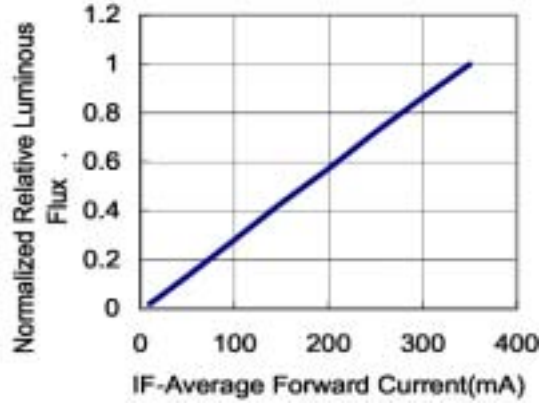

Fig 4b. Relative Luminous Flux vs. Forward Current for Yellow and Red at $T_j=25^\circ\text{C}$ maintained.

Current Derating Curves

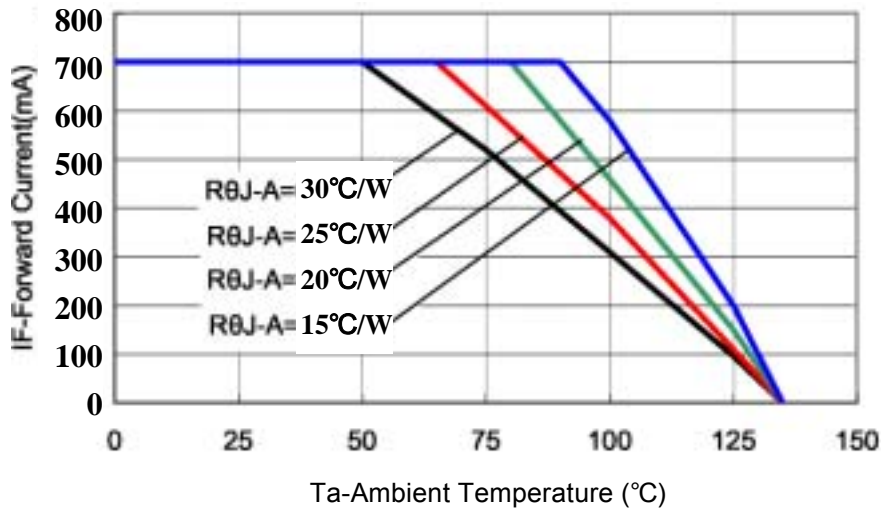

Fig 5a. Maximum Forward Current vs. Ambient Temperature. Derating based on $T_{iMAX}=135^{\circ}\text{C}$ for White, Blue and Green.

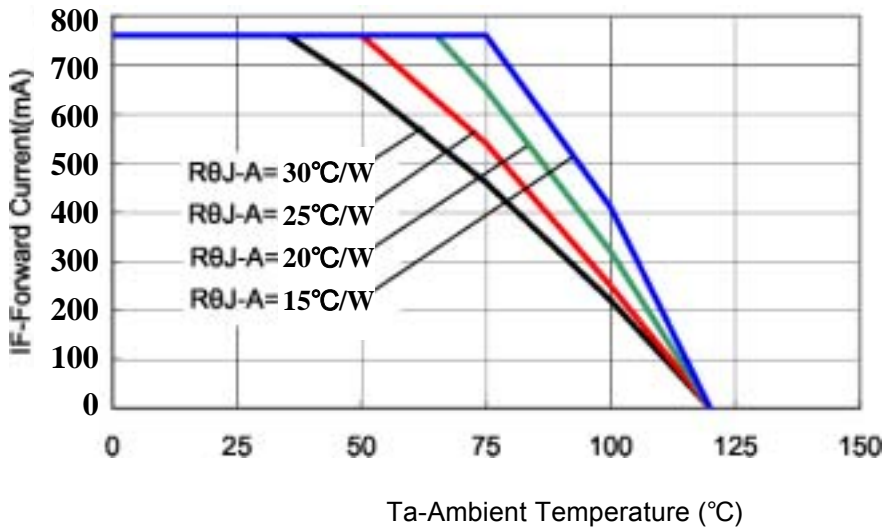

Fig 5b. Maximum Forward Current vs. Ambient Temperature. Derating based on $T_{jMAX}=120^{\circ}\text{C}$ for Yellow and Red.

Typical Representative Spatial Radiation Pattern

Lambertian Radiation Pattern

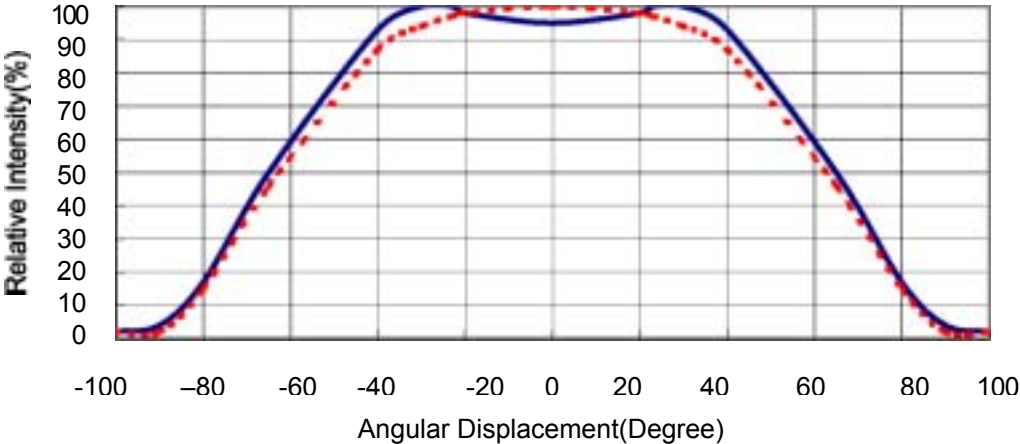

Fig 6. Typical Representative Spatial Radiation Pattern for White, Blue, Green, Yellow and Red.