

■Features

- High Luminous LEDs
- 5mm Round Standard Directivity
- Long Lifetime Operation
- Superior Weather-resistance
- UV Resistant Epoxy
- AC LED

■Applications

- Toys
- Audio
- Games
- Other Lighting

■Outline Dimension

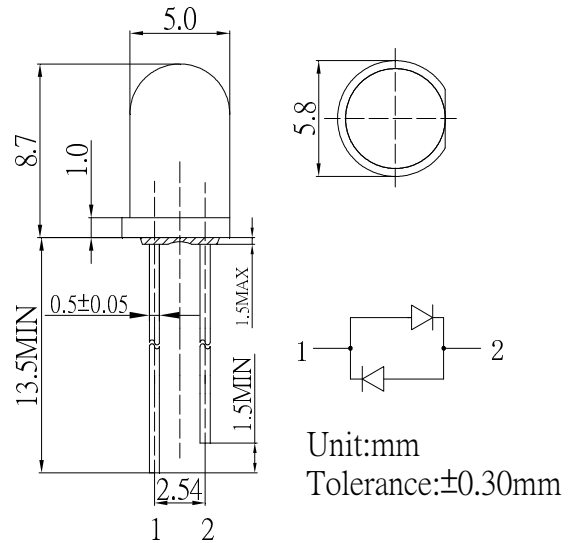

■Absolute Maximum Rating

(Ta=25°C)

Item	Symbol	Value		Unit
		Blue	Blue	
DC Forward Current	I _F	30	30	mA
Pulse Forward Current*	I _{FP}	100	100	mA
Reverse Voltage	V _R	5	5	V
Power Dissipation	P _D	108	108	mW
Operating Temperature	Topr	-30 ~ +85		°C
Storage Temperature	Tstg	-40~ +100		°C
Lead Soldering Temperature	Tsol	260°C/5sec		-

■Directivity

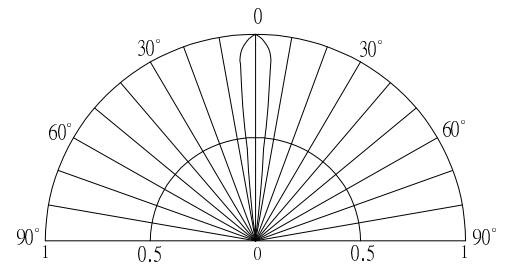

*Pulse width Max.10ms Duty ratio max 1/10

■Electrical -Optical Characteristics

(Ta=25°C)

Item	Symbol	Condition	Min.	Typ.	Max.	Unit
DC Forward Voltage	V _F (Blue)	I _F =20mA	2.9	3.1	3.6	V
	V _F (Blue)	I _F =20mA	2.9	3.1	3.6	V
DC Reverse Current	I _R	V _R =5V	-	-	10	μA
Domi. Wavelength*	λ _D	I _F =20mA	465	470	475	nm
	λ _D	I _F =20mA	465	470	475	nm
Luminous Intensity*	I _v (Blue)	I _F =20mA	4200	5800	-	mcd
	I _v (Blue)	I _F =20mA	4200	5800	-	mcd
50% Power Angle	2θ _{1/2}	I _F =20mA	-	15	-	deg

*1 Tolerance of measurements of dominant wavelength is ±1nm

*2 Tolerance of measurements of luminous intensity is ±15%

*3 Tolerance of measurements of forward voltage is±0.1V