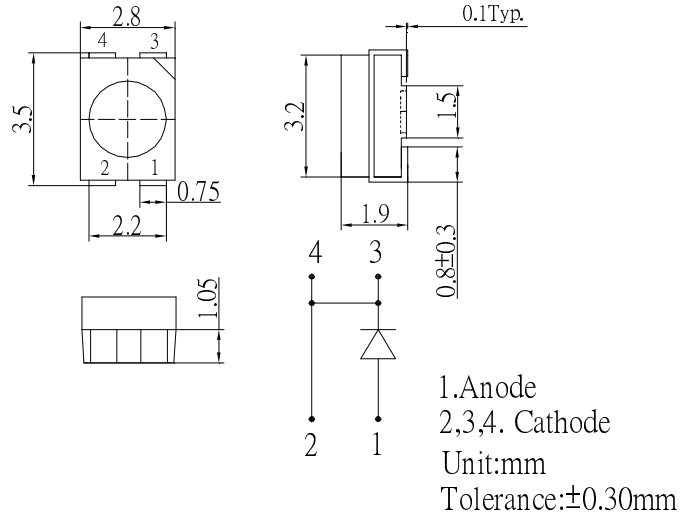

■Features

- High Luminous PLCC4 Power Top SMD LEDs
- 3.5x2.8x1.9mm Standard Directivity
- Long Lifetime Operation
- Superior Weather-resistance
- UV Resistant Epoxy
- Water Clear Type

■Applications

- Traffic Signal
- Backlighting
- Signal and channel letter
- Other Lighting

■Outline Dimension

■Absolute Maximum Rating

(Ta=25°C)

Item	Symbol	Value	Unit
DC Forward Current	I _F	50	mA
Pulse Forward Current*	I _{FP}	120	mA
Reverse Voltage	V _R	5	V
Power Dissipation	P _D	130	mW
Operating Temperature	Topr	-30 ~ +85	°C
Storage Temperature	Tstg	-40~ +100	°C
Lead Soldering Temperature	Tsol	260°C/5sec	-

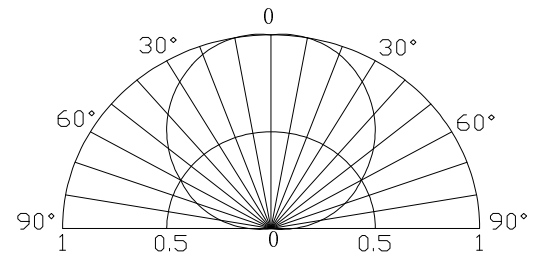
*Pulse width Max.10ms Duty ratio max 1/10

■Directivity

■Electrical -Optical Characteristics

(Ta=25°C)

Item	Symbol	Condition	Min.	Typ.	Max.	Unit
DC Forward Voltage	V _F	I _F =30mA	2.0	2.2	2.6	V
DC Reverse Current	I _R	V _R =5V	-	-	10	μA
Domi. Wavelength*	λ _D	I _F =30mA	585	590	595	nm
Luminous Intensity*	I _v	I _F =30mA	1560	2180	-	mcd
50% Power Angle	2θ _{1/2}	I _F =30mA	-	120	-	deg

*1 Tolerance of dominant wavelength is ±1nm

*2 Tolerance of luminous intensity is ±15%

■Maximum Forward Current

 Maximum Permissible Forward Current T_J=115°C
