

Sample Approval Sheet

(Product type):Chip LED		
(Product name): 0603 Yellowish Green LED		
(Part No.):		
(Sample No.):		
(Acknowledgement Numbers):201808070001		
(Signatures)		
(Approved)	(Checked)	(Drawn)

(Customer)		
(Corporation):		
(Material No.):		
(Part No.):		
(Customer Signatures)		

Feature

- *Low power consumption
- *Long life-solid state reliability
- *Available on tape and reel
- *RoHS compliant

Package outline dimensions

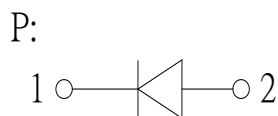
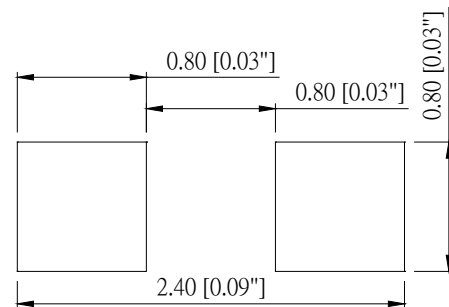
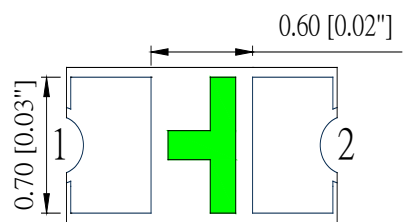
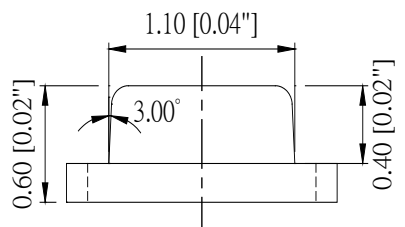
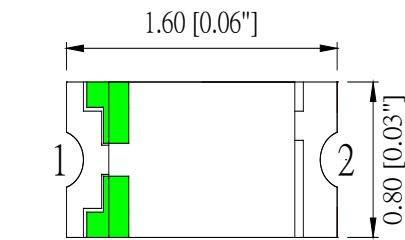

Note:

1. All dimensions are in millimeters (mm);
2. X.X is +/-0.1mm,X.XX is +/- 0.05mm unless otherwise noted;
3. The device has a single mounting surface, the device must be mounted according to the specifications.

Electrical characteristics data sheet

Selection Guide

Part No.	Emitted Color	Resin color	Viewing Angle $2\theta_{1/2}$
	Yellow Green	Water transparent	130°

Absolute Maximum Ratings at Ta=25°C

Parameter	Symbol	Value	Unit
Power dissipation	Pd	70	mW
DC Forward Current	If	30	mA
Peak Forward Current ⁽¹⁾	Ifp	70	mA
Reverse Voltage	Vr	5	V
Electro-Static-Discharge ⁽²⁾ (HBM)	ESD	1000	V
Operating Temperature	Topr	-25to+85	°C
Storage Temperature	Tstg	-40to+100	°C
Lead Solder Temperature	Tsol	250 for 5sec	°C

Notes:

- 1/10 duty cycle,0.1ms pulse width
2. The products are sensitive to static electricity and must be carefully taken when handling products.

Electrical/Optical Characteristics Ta=25°C

Parameter	Symbol	Condition	Value			Unit
			Min.	Typ.	Max.	
Forward voltage	VF	If=20mA	1.8	--	2.2	V
Luminous intensity	IV	If=20mA	--	45	--	mcd
Dominant wavelength	WLD	If=20mA	---	573	---	nm
Peak wavelength	WLP	If=20mA	---	571	---	nm
Reverse current	Ir	Vr=5V	---	---	10	μA

Notes:

1. Forward voltage: ±0.1V
2. Dominant Wavelength: ±1nm
3. Luminous intensity: ±10%

Typical Electro-Optical Characteristics Curves

FORWARD CURRENT VS. FORWARD VOLTAGE

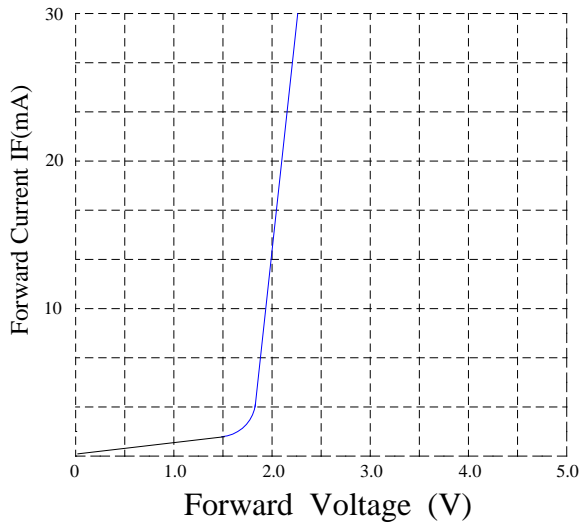

FORWARD CURRENT VS. LUMINOUS INTENSITY

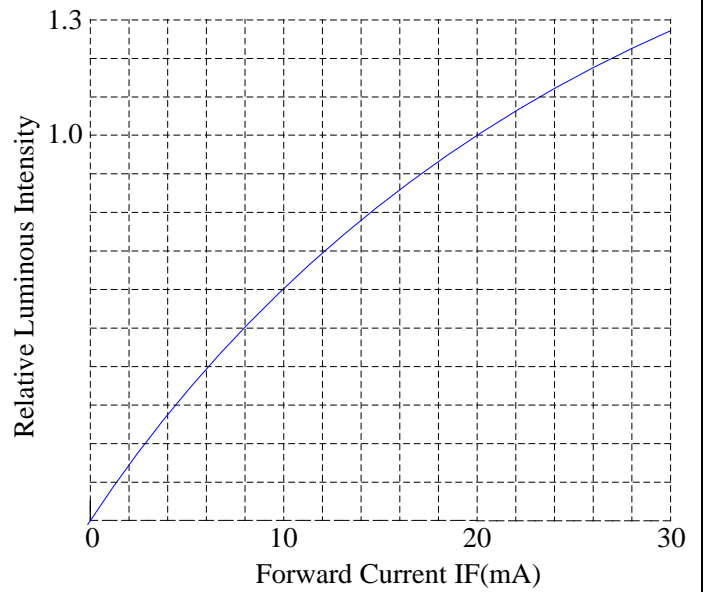

AMBIENT TEMPERATURE VS. FORWARD CURRENT

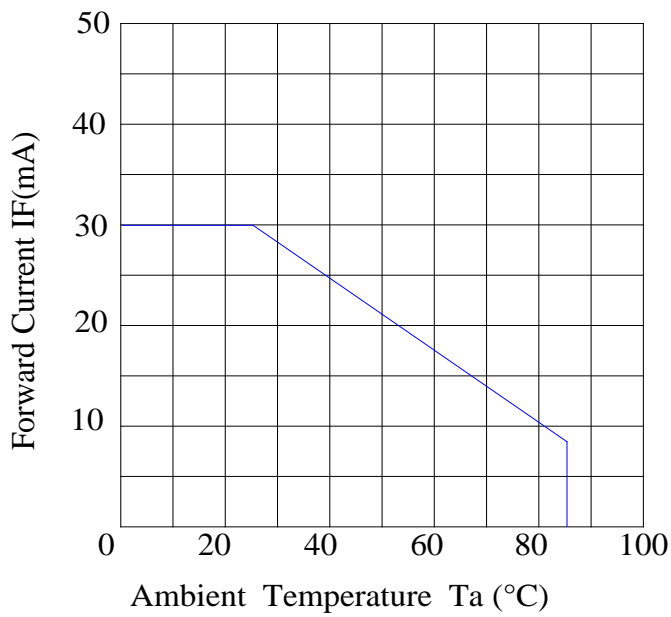

RADIATION DIAGRAM

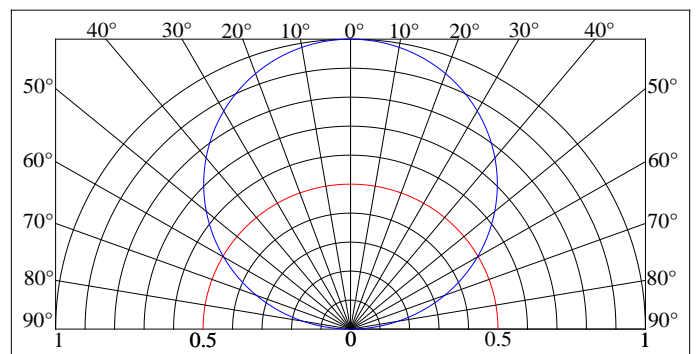

Bin Range of Technical Data Sheet

Voltage code (IF=20mA, Ta=25°C)			Luminous code (IF=20mA, Ta=25°C)		
Bin Code	Forward voltage (V)		Bin Code	Luminous Intensity (mcd)	
	min	max		min	max
5	1.8	1.9	F	25	32
6	1.9	2	G	32	40
7	2	2.1	H	40	50
A	2.1	2.2	I	50	63
B	2.2	2.3	J	63	80
C	2.3	2.4			

Color Bin Limits

Color code (IF=20mA, Ta=25°C)		
Bin Code	Dominant wavelength (nm)	
	min	max
YG6	562	564
YG7	564	566
YG8	566	568
YG9	568	570
YG10	570	572
YG11	572	574

Notes:

- 1、Tolerance of forward voltage for each Bin limit is $\pm 0.1\text{v}$.
- 2、Tolerance of luminous intensity for each Bin limit is $\pm 10\%$.
- 3、Tolerance of wavelength for each Bin limit is $\pm 1\text{nm}$.

Reliability Test Items and Conditions

1、 Test items and result

Test Item	Ref. Standard	Test Condition	Note	Number of Damaged
Resistance to Soldering Heat	JESD22-B106	Tsld=260°C,10sec	2 times	0/100
Temperature Cycle	JESD22-A104	-40°C 30min ↓↑ 5min 100°C 30min	10 cycle	0/100
Thermal Shock	JESD22-A106	-40°C 15min ↑↓ 100°C 15min	10 cycle	0/100
Power temperature Cycling	JESD22-A105	On 5min -40°C>15min ↑↓↑↓<15min Off 5min 100°C>15min	10 cycle	0/100
High temperature Storage	JESD22-A103	Ta=100 °C	1000 hrs	0/100
Low temperature Storage	JESD22-A119	Ta=-40°C	1000 hrs	0/100
Lift Test	JESD22-A108	Ta=25°C IF=20mA	1000 hrs	0/20
High Humidity Heat Lift Test	JESD22-A101	60°C RH=90 % IF=20mA	1000 hrs	0/20

2、 Criteria for judging damage

Item	Symbol	Test Conditions	Criteria for Judgment	
			Min	Max
Forward voltage	VF	IF=20mA	--	U.S.L*)×1.1
Reverse current	IR	VR=5V	--	U.S.L*)×2.0
Luminous intensity	IV	IF=20mA	L.S.L***)×0.7	--

Notes:

U.S.L.: Upper Standard Level

L.S.L.: Lower Standard Level

Packaging Dimensions Specification

1、Carrier tape dimensions

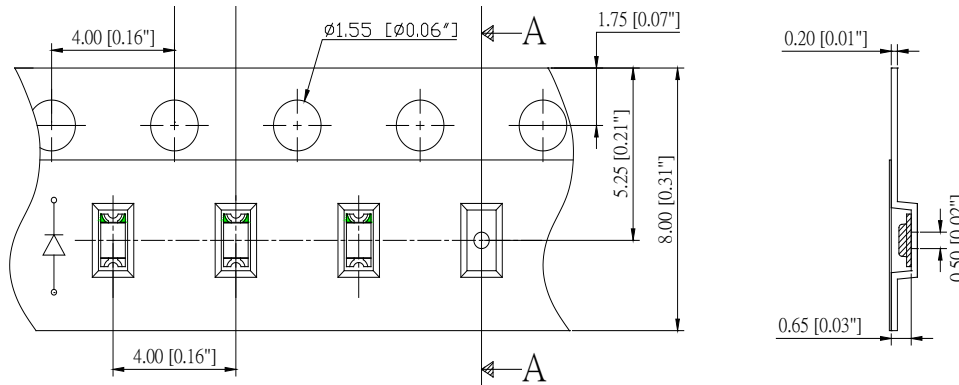

Notes:

- 1) All dimensions are in millimeters
- 2) Tolerance is ± 0.15 unless otherwise noted

2、Details of carrier tape

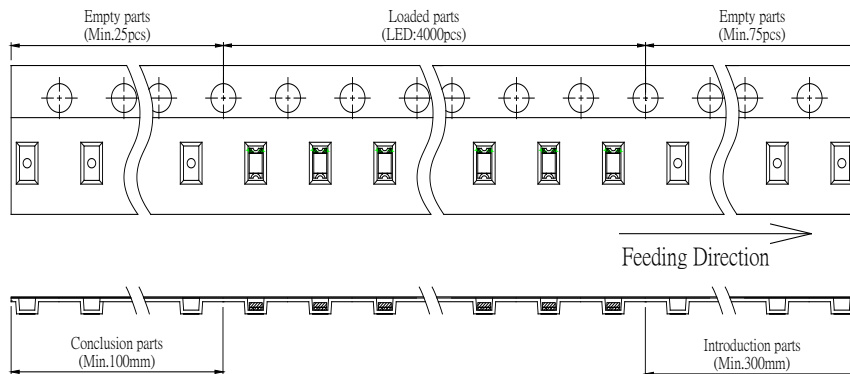

3、Reel dimensions(带盘尺寸)

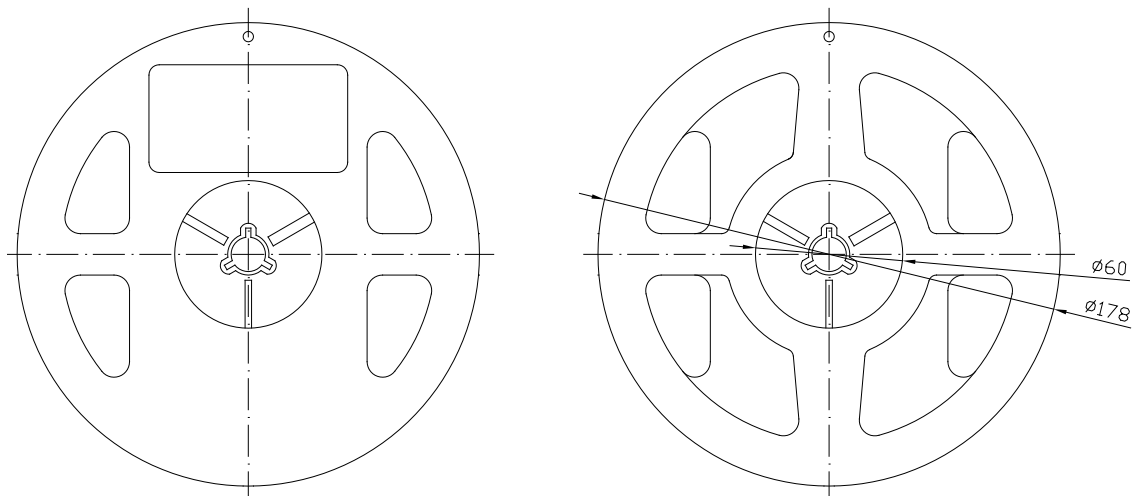

Packaging Dimensions Specification

4、Moisture-Proof and anti-static electricity

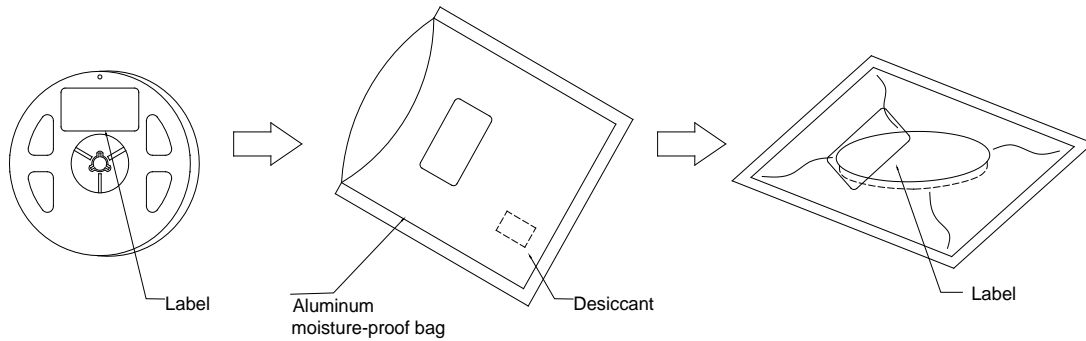

5、Label

	RoHS
Part No. :	
VF (v) :	*****
IV (mcd) :	*****
WLD (nm) :	*****
Q' TY (pcs) :	*****
Lot No. :	*****

Label Explanation:

VF	: Forward voltage
IV	: Luminous intensity
WLD	: Dominant wavelength
VF\IV\WLD used to represent the corresponding Bin code	

Precautions

1、 Requirements for application and reflow soldering:

Use the recommended curve in the under figure of Pb-free reflow soldering.

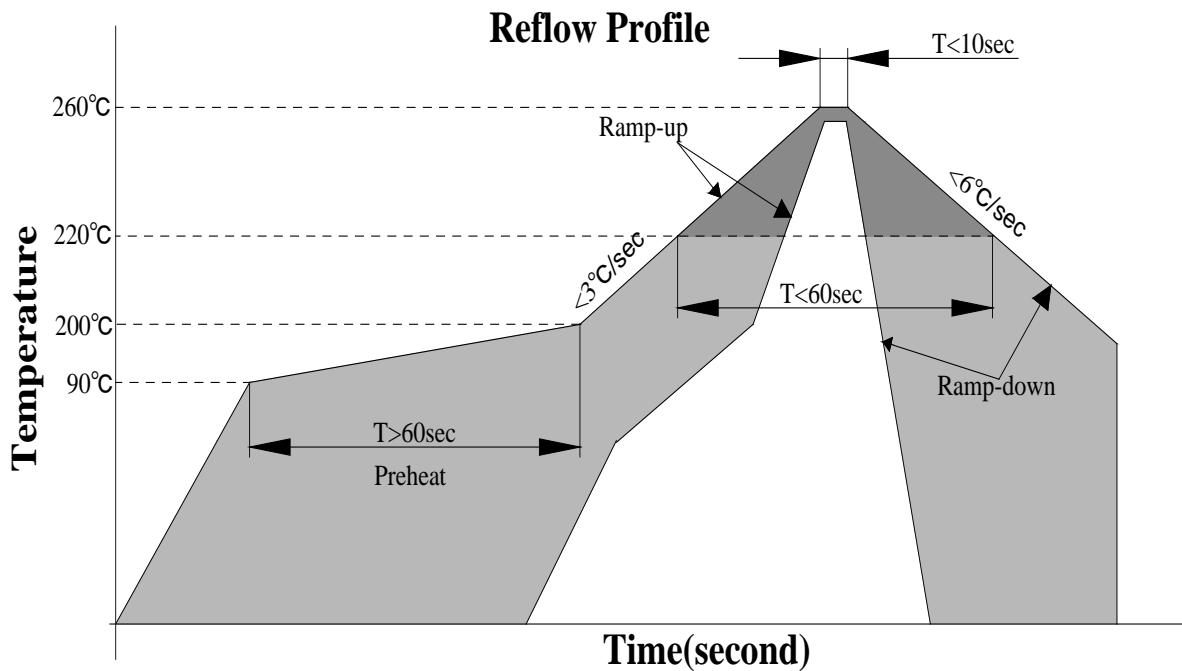

☆ Notes for reflow soldering:

- 1) No more than twice for reflow soldering.
- 2) To ensure the quality of our LEDs, please do not put pressure on the lens of LEDs.
- 3) Please choose the right nozzle to avoid the damage to products due to the pressure.
- 4) Please put on the antistatic hand loop during the use. The worktable should be with antistatic finish. The equipments must be contacted with ground

☆ Handwork soldering:

- 1) During the soldering, the electronic soldering iron must be kept under the temperature of 350°C and the soldering time must not be beyond 3 seconds. No touch between the electronic soldering iron and colloid.
- 2) Handwork soldering is only allowed once. We won't take responsibility for more than that.
- 3) Avoid using sharp objects to compress products Colloidal Part directly.
- 4) Please put on the antistatic hand loop during the use. The worktable should be with antistatic finish. The equipments must be contacted with ground.

2、 Storage

- ☆ Moisture proof and anti-electrostatic package with moisture absorbent material is used to keep moisture to a minimum. Before opening the package, the product should be kept at 30°C or less and humidity less than 60%RH ,and be used in six months.
- ☆ After opening the package, the product should be stored at 30°C or less and humidity less than 10%RH, and be soldered within 24 hours. It is recommended that the product be operated at the workshop condition of 30°C or less and humidity less than 60%RH.
- ☆ If the moisture absorbent material has faded away or the LEDs have exceeded the storage time, baking treatment should be performed based on the following condition (75±5) °C for 24 hours.

3、 Static electricity

- ☆ Static electricity or surge voltage damages the LEDs. Damaged LEDs will show some unusual characteristics such as the forward voltage coming lower, or the LEDs do not light at the low current, even not light. All devices, equipment and machinery must be properly grounded. At the same time, it is recommended that wrist bands or anti-electrostatic gloves, anti-electrostatic containers be used when dealing with the LEDs.

4、 Vulcanization

- ☆ LED curing is due to sulfur being in bracket and the +1 price of silver in the chemical reaction generated Ag₂S in the process. It will lead to the capacity of reflecting of silver layer reducing, light color temperature drift and serious decline, seriously affecting the performance of the product. So we should take corresponding measures to avoid vulcanization. Such as to avoid using sulphur volatile substances and keeping away from high sulphur content of the material.

5、 Safety advice for human eyes

- ☆ Viewing direct to the light emitting center of the LEDs, especially those of great luminous intensity will cause great hazard to human eyes. Please be careful.

6、 Design consideration

- ☆ In designing a circuit about LED, the current through each LED must not exceed the absolute maximum rating specified for each LED. In the meanwhile, resistors for protection should be applied, otherwise slight voltage shift will cause big current change, burn out may happen.