

## Optocoupler, Phototransistor Output, With Base Connection

### Features

- Isolation materials according to UL94-VO
- Pollution degree 2 (DIN/VDE 0110 / resp. IEC 60664)
- Climatic classification 55/100/21 (IEC 60068 part 1)
- Special construction: Therefore, extra low coupling capacity of typical 0.2 pF, high **Common Mode Rejection**
- Low temperature coefficient of CTR
- CTR offered in 3 groups
- Rated isolation voltage (RMS includes DC)  
 $V_{IOWM} = 600 V_{RMS}$  (848 V peak)
- Rated recurring peak voltage (repetitive)  
 $V_{IORM} = 600 V_{RMS}$
- Creepage current resistance according to VDE 0303/IEC 60112 **Comparative Tracking Index: CTI**  $\geq 275$
- Thickness through insulation  $\geq 0.75$  mm
- Lead-free component
- Component in accordance to RoHS 2002/95/EC and WEEE 2002/96/EC

### Agency Approvals

- UL1577, File No. E76222 System Code A, Double Protection
- BSI: BS EN 41003, BS EN 60095 (BS 415), BS EN 60950 (BS 7002), Certificate number 7081 and 7402
- DIN EN 60747-5-2 (VDE0884)  
DIN EN 60747-5-5 pending
- VDE related features:
- Rated impulse voltage (transient overvoltage)  
 $V_{IOTM} = 6$  kV peak
- Isolation test voltage (partial discharge test voltage)  $V_{pd} = 1.6$  kV
- FIMKO (SETI): EN 60950, Certificate No. 12399

### Applications

Circuits for safe protective separation against electrical shock according to safety class II (reinforced isolation):

For appl. class I - IV at mains voltage  $\leq 300$  V

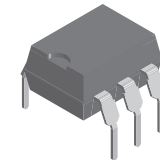
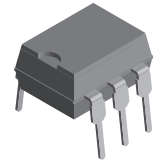
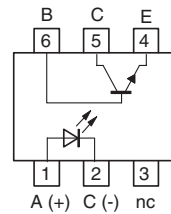

17186

For appl. class I - III at mains voltage  $\leq 600$  V according to DIN EN 60747-5-2(VDE0884)/ DIN EN 60747-5-5 pending, table 2, suitable for:

**Switch-mode power supplies, line receiver, computer peripheral interface, microprocessor system interface.**

### Description

The CNY75A/ B/ C/ GA/ GB/ GC consists of a phototransistor optically coupled to a gallium arsenide infrared-emitting diode in a 6-pin plastic dual in-line package.

The elements are mounted on one leadframe providing a fixed distance between input and output for highest safety requirements.

### VDE Standards

These couplers perform safety functions according to the following equipment standards:

**DIN EN 60747-5-2(VDE0884)/ DIN EN 60747-5-5 pending**

Optocoupler for electrical safety requirements  
**IEC 60950/ EN 60950**

Office machines (applied for reinforced isolation for mains voltage  $\leq 400$  VRMS)

**VDE 0804**

Telecommunication apparatus and data processing  
**IEC 60065**

Safety for mains-operated electronic and related house hold apparatus

### Order Information

Part	Remarks
CNY75A	CTR 63 - 125 %, DIP-6
CNY75B	CTR 100 - 200 %, DIP-6
CNY75C	CTR 160 - 320 %, DIP-6
CNY75GA	CTR 63 - 125 %, DIP-6
CNY75GB	CTR 100 - 200 %, DIP-6
CNY75GC	CTR 160 - 320 %, DIP-6

G = Leadform 10.16 mm; G is not marked on the body

For additional information on the available options refer to Option Information.

### Absolute Maximum Ratings

$T_{amb} = 25\text{ }^{\circ}\text{C}$ , unless otherwise specified

Stresses in excess of the absolute Maximum Ratings can cause permanent damage to the device. Functional operation of the device is not implied at these or any other conditions in excess of those given in the operational sections of this document. Exposure to absolute Maximum Rating for extended periods of the time can adversely affect reliability.

### Input

Parameter	Test condition	Symbol	Value	Unit
Reverse voltage		$V_R$	5	V
Forward current		$I_F$	60	mA
Forward surge current	$t_p \leq 10\text{ }\mu\text{s}$	$I_{FSM}$	3	A
Power dissipation		$P_{diss}$	100	mW
Junction temperature		$T_j$	125	$^{\circ}\text{C}$

### Output

Parameter	Test condition	Symbol	Value	Unit
Collector base voltage		$V_{CBO}$	90	V
Collector emitter voltage		$V_{CEO}$	90	V
Emitter collector voltage		$V_{ECO}$	7	V
Collector current		$I_C$	50	mA
Collector peak current	$t_p/T = 0.5$ , $t_p \leq 10\text{ ms}$	$I_{CM}$	100	mA
Power dissipation		$P_{diss}$	150	mW
Junction temperature		$T_j$	125	$^{\circ}\text{C}$

### Coupler

Parameter	Test condition	Symbol	Value	Unit
AC isolation test voltage (RMS)	$t = 1\text{ min}$	$V_{ISO}$	3750	$V_{RMS}$
Total power dissipation		$P_{tot}$	250	mW
Ambient temperature range		$T_{amb}$	- 55 to + 100	$^{\circ}\text{C}$
Storage temperature range		$T_{stg}$	- 55 to + 125	$^{\circ}\text{C}$
Soldering temperature	2 mm from case, $t \leq 10\text{ s}$	$T_{sld}$	260	$^{\circ}\text{C}$



### Electrical Characteristics

T<sub>amb</sub> = 25 °C, unless otherwise specified

Minimum and maximum values are testing requirements. Typical values are characteristics of the device and are the result of engineering evaluation. Typical values are for information only and are not part of the testing requirements.

### Input

Parameter	Test condition	Symbol	Min	Typ.	Max	Unit
Forward voltage	I <sub>F</sub> = 50 mA	V <sub>F</sub>		1.25	1.6	V
Reverse current	V <sub>R</sub> = 6 V	I <sub>R</sub>			10	μA
Junction capacitance	V <sub>R</sub> = 0, f = 1 MHz	C <sub>j</sub>		50		pF

### Output

Parameter	Test condition	Symbol	Min	Typ.	Max	Unit
Collector base voltage	I <sub>C</sub> = 100 μA	V <sub>CBO</sub>	90			V
Collector emitter voltage	I <sub>C</sub> = 1 mA	V <sub>CEO</sub>	90			V
Emitter collector voltage	I <sub>E</sub> = 100 μA	V <sub>ECO</sub>	7			V
Collector-emitter leakage current	V <sub>CE</sub> = 20 V, I <sub>F</sub> = 0	I <sub>CEO</sub>			150	nA

### Coupler

Parameter	Test condition	Symbol	Min	Typ.	Max	Unit
Collector emitter saturation voltage	I <sub>F</sub> = 10 mA, I <sub>C</sub> = 1 mA	V <sub>CEsat</sub>			0.3	V
Cut-off frequency	V <sub>CE</sub> = 5 V, I <sub>F</sub> = 10 mA, R <sub>L</sub> = 100 Ω	f <sub>c</sub>		110		kHz
Coupling capacitance	f = 1 MHz	C <sub>k</sub>		0.3		pF

### Current Transfer Ratio

Parameter	Test condition	Part	Symbol	Min	Typ.	Max	Unit
I <sub>C</sub> /I <sub>F</sub>	V <sub>CE</sub> = 5 V, I <sub>F</sub> = 1 mA	CNY75GA	CTR	15			%
		CNY75GB	CTR	30			%
		CNY75GC	CTR	60			%
	V <sub>CE</sub> = 5 V, I <sub>F</sub> = 10 mA	CNY75GA	CTR	63		1.25	%
		CNY75GB	CTR	100		200	%
		CNY75GC	CTR	160		320	%

### Switching Characteristics

Parameter	Current	Delay	Rise time	Storage	Fall time	Turn-on time	Turn-off time	Turn-on time	Turn-off time
Test condition	V <sub>CC</sub> = 5 V, R <sub>L</sub> = 100 Ω (see figure 3)						V <sub>CC</sub> = 5 V, R <sub>L</sub> = 1.0 kΩ (see figure 4)		
Symbol	I <sub>F</sub>	t <sub>D</sub>	t <sub>r</sub>	t <sub>S</sub>	t <sub>f</sub>	t <sub>on</sub>	t <sub>off</sub>	t <sub>on</sub>	t <sub>off</sub>
Unit	mA	μs	μs	μs	μs	μs	μs	μs	μs
CNY75GA	10	2.0	2.5	0.3	2.7	4.5	3.0	10.0	25.0
CNY75GB	10	2.5	3.0	0.3	3.7	5.5	4.0	16.5	20.0
CNY75GC	10	2.8	4.2	0.3	4.7	7.0	5.0	11.0	37.5

### Maximum Safety Ratings

(according to DIN EN 60747-5-2(VDE0884)/ DIN EN 60747-5-5 pending) see figure 1  
 This optocoupler is suitable for safe electrical isolation only within the safety ratings.  
 Compliance with the safety ratings shall be ensured by means of suitable protective circuits.

### Input

Parameter	Test condition	Symbol	Min	Typ.	Max	Unit
Forward current		$I_F$			130	mA

### Output

Parameter	Test condition	Symbol	Min	Typ.	Max	Unit
Power dissipation		$P_{diss}$			265	mW

### Coupler

Parameter	Test condition	Symbol	Min	Typ.	Max	Unit
Rated impulse voltage		$V_{IOTM}$			6	kV
Safety temperature		$T_{si}$			150	°C

### Insulation Rated Parameters

Parameter	Test condition	Symbol	Min	Typ.	Max	Unit
Partial discharge test voltage - Routine test	100 %, $t_{test} = 1$ s	$V_{pd}$	1.6			kV
Partial discharge test voltage - Lot test (sample test)	$t_{Tr} = 60$ s, $t_{test} = 10$ s, (see figure 2)	$V_{IOTM}$	6			kV
		$V_{pd}$	1.3			kV
Insulation resistance	$V_{IO} = 500$ V	$R_{IO}$	$10^{12}$			$\Omega$
	$V_{IO} = 500$ V, $T_{amb} \leq 100$ °C	$R_{IO}$	$10^{11}$			$\Omega$
	$V_{IO} = 500$ V, $T_{amb} \leq 150$ °C (construction test only)	$R_{IO}$	$10^9$			$\Omega$

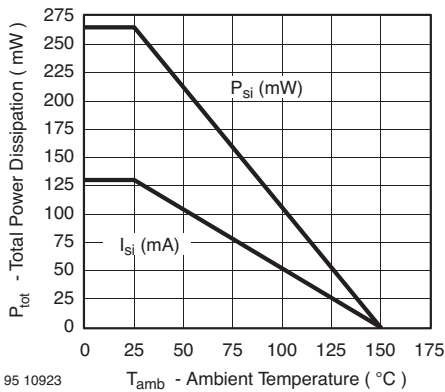

Figure 1. Derating diagram

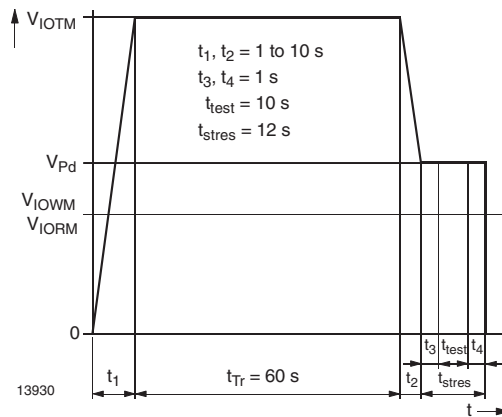

Figure 2. Test pulse diagram for sample test according to DIN EN 60747-5-2(VDE0884)/ DIN EN 60747-5; IEC60747

## Typical Characteristics ( $T_{amb} = 25\text{ }^{\circ}\text{C}$ unless otherwise specified)

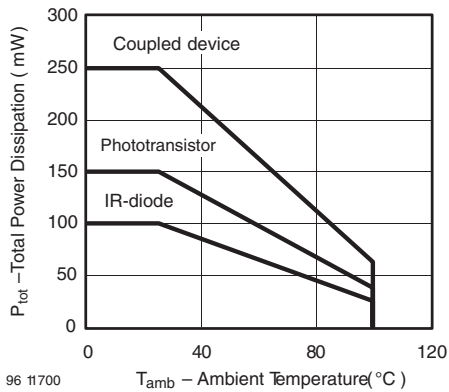

Figure 3. Total Power Dissipation vs. Ambient Temperature

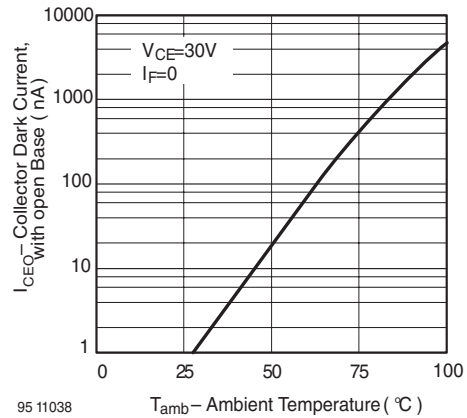

Figure 6. Collector Dark Current vs. Ambient Temperature

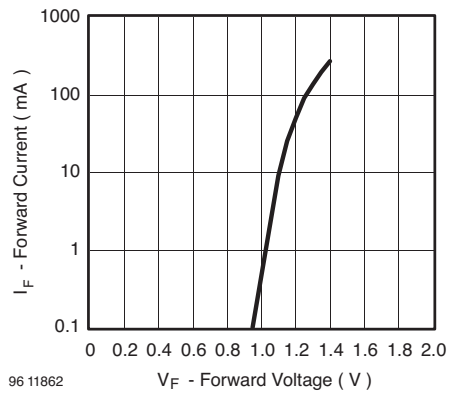

Figure 4. Forward Current vs. Forward Voltage

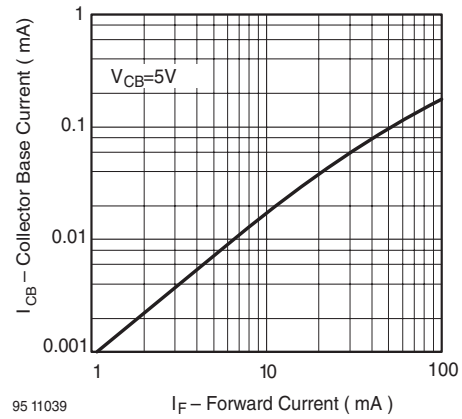

Figure 7. Collector Base Current vs. Forward Current

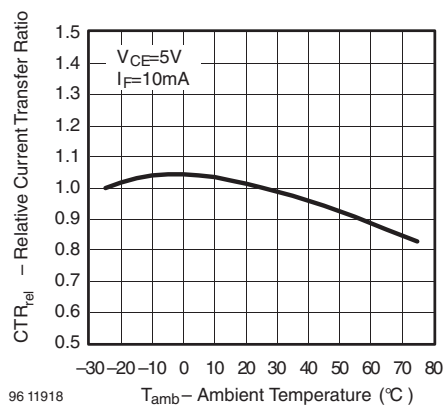

Figure 5. Relative Current Transfer Ratio vs. Ambient Temperature

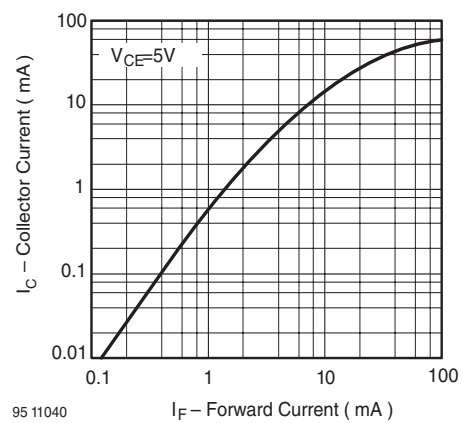

Figure 8. Collector Current vs. Forward Current

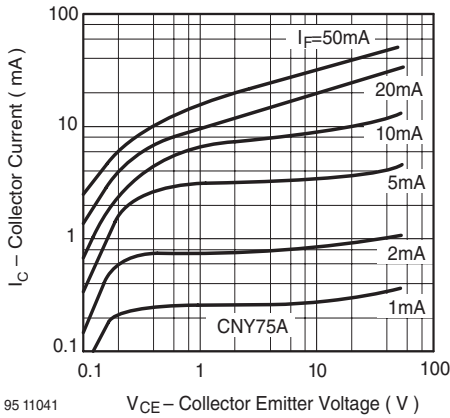

Figure 9. Collector Current vs. Collector Emitter Voltage

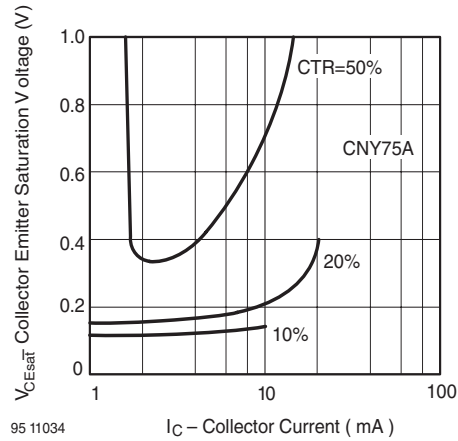

Figure 12. Collector Emitter Saturation Voltage vs. Collector Current

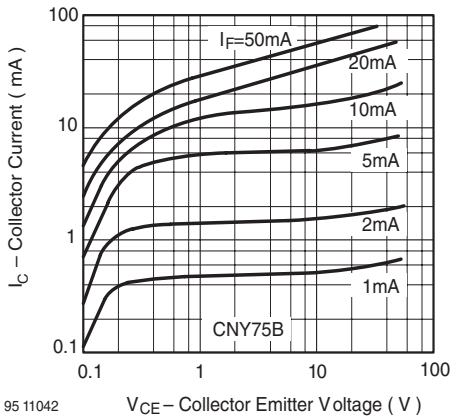

Figure 10. Collector Current vs. Collector Emitter Voltage

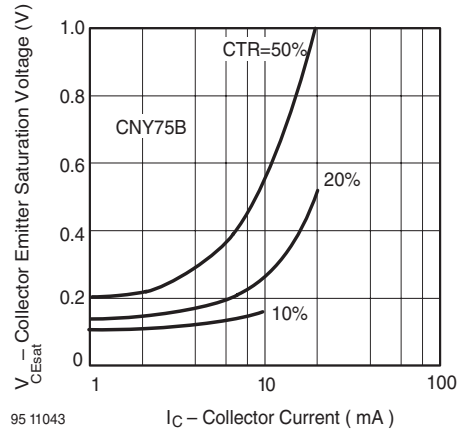

Figure 13. Collector Emitter Saturation Voltage vs. Collector Current

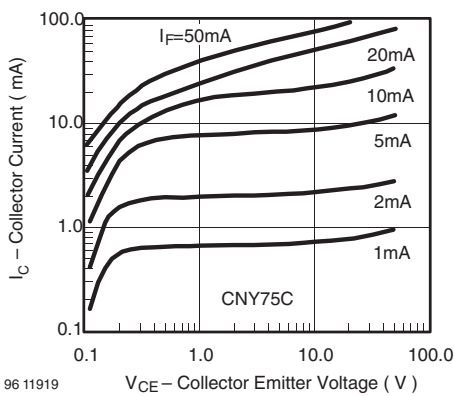

Figure 11. Collector Current vs. Collector Emitter Voltage

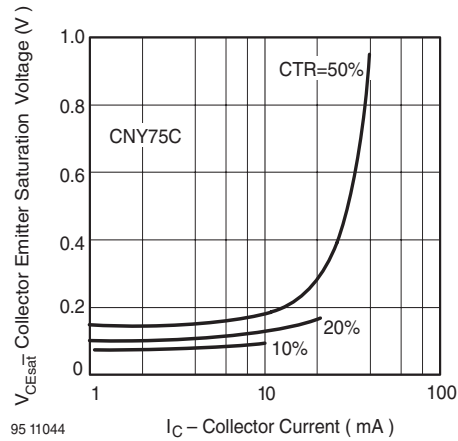

Figure 14. Collector Emitter Saturation Voltage vs. Collector Current

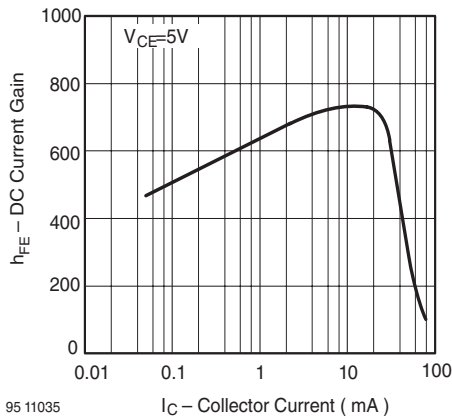

Figure 15. DC Current Gain vs. Collector Current

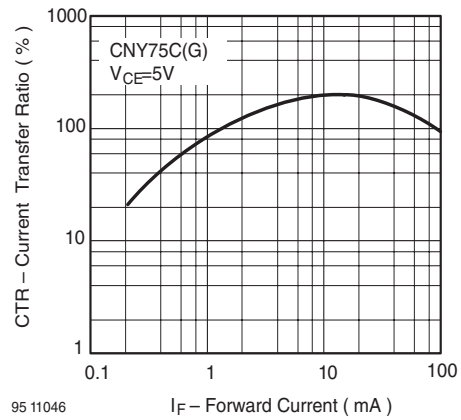

Figure 18. Current Transfer Ratio vs. Forward Current

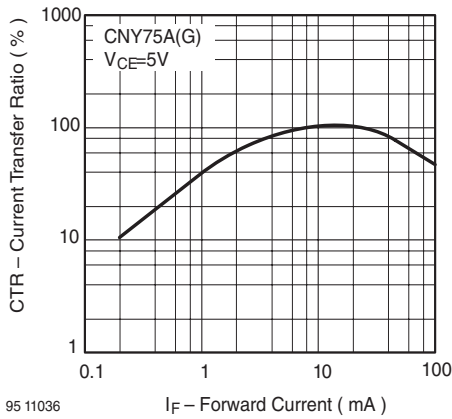

Figure 16. Current Transfer Ratio vs. Forward Current

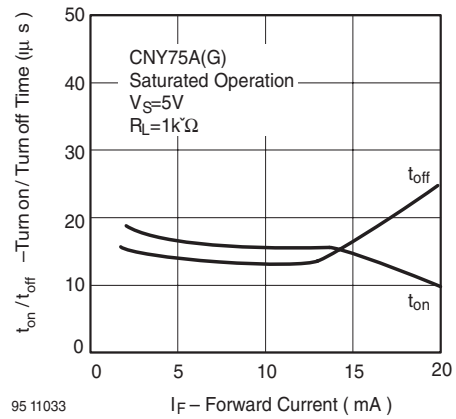

Figure 19. Turn on / off Time vs. Forward Current

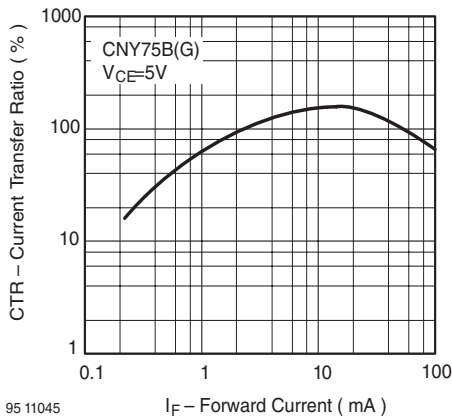

Figure 17. Current Transfer Ratio vs. Forward Current

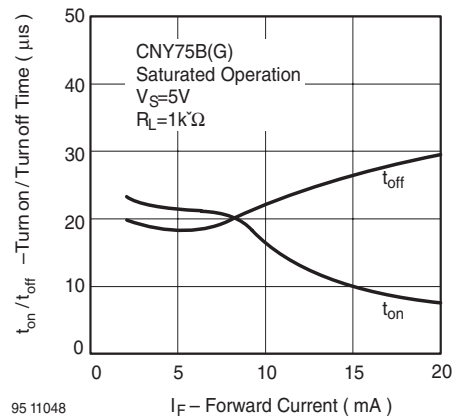

Figure 20. Turn on / off Time vs. Forward Current

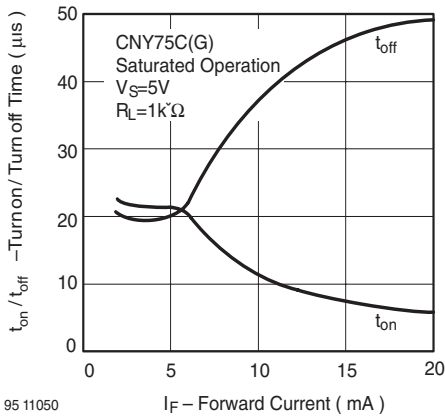

Figure 21. Turn on / off Time vs. Forward Current

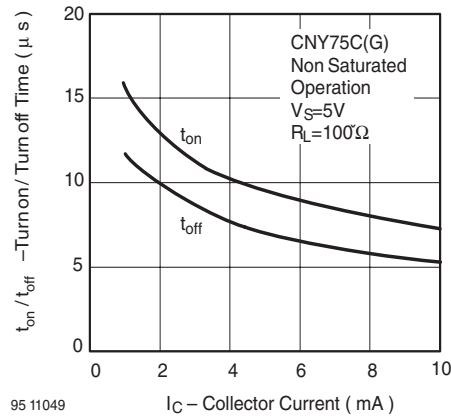

Figure 24. Turn on / off Time vs. Collector Current

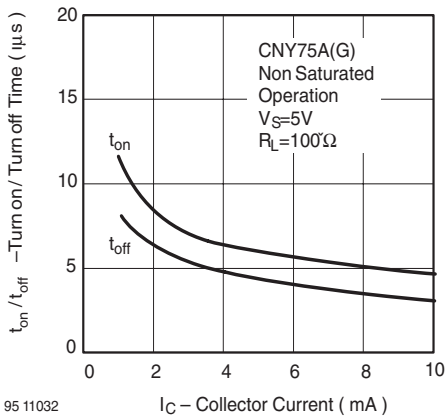

Figure 22. Turn on / off Time vs. Collector Current

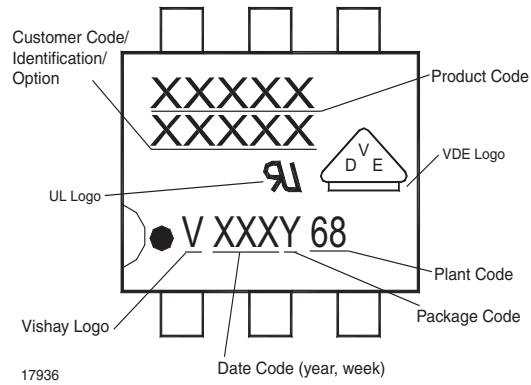

Figure 25. Marking example

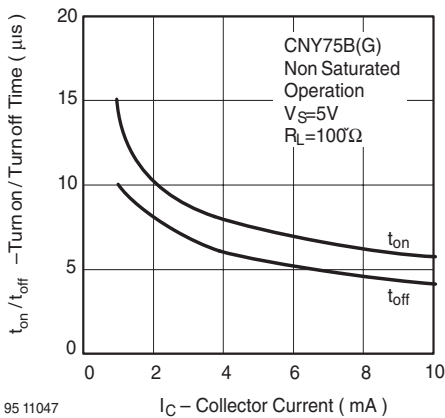
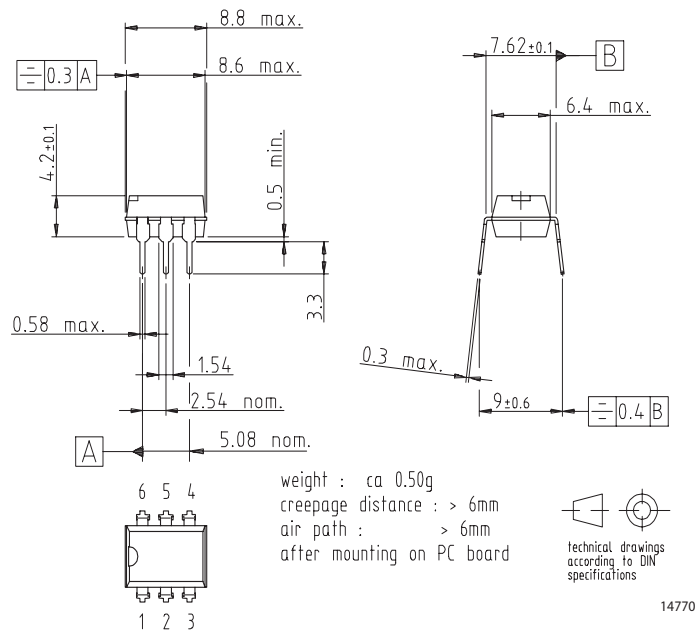

Figure 23. Turn on / off Time vs. Collector Current



## Package Dimensions in mm



## Package Dimensions in mm

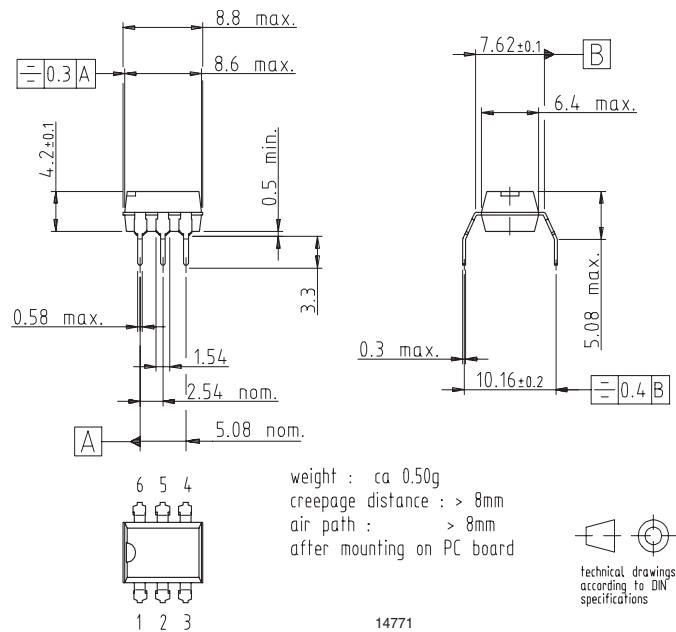

### Ozone Depleting Substances Policy Statement

It is the policy of Vishay Semiconductor GmbH to

1. Meet all present and future national and international statutory requirements.
2. Regularly and continuously improve the performance of our products, processes, distribution and operating systems with respect to their impact on the health and safety of our employees and the public, as well as their impact on the environment.

It is particular concern to control or eliminate releases of those substances into the atmosphere which are known as ozone depleting substances (ODSs).

The Montreal Protocol (1987) and its London Amendments (1990) intend to severely restrict the use of ODSs and forbid their use within the next ten years. Various national and international initiatives are pressing for an earlier ban on these substances.

Vishay Semiconductor GmbH has been able to use its policy of continuous improvements to eliminate the use of ODSs listed in the following documents.

1. Annex A, B and list of transitional substances of the Montreal Protocol and the London Amendments respectively
2. Class I and II ozone depleting substances in the Clean Air Act Amendments of 1990 by the Environmental Protection Agency (EPA) in the USA
3. Council Decision 88/540/EEC and 91/690/EEC Annex A, B and C (transitional substances) respectively.

Vishay Semiconductor GmbH can certify that our semiconductors are not manufactured with ozone depleting substances and do not contain such substances.

We reserve the right to make changes to improve technical design  
and may do so without further notice.

Parameters can vary in different applications. All operating parameters must be validated for each customer application by the customer. Should the buyer use Vishay Semiconductors products for any unintended or unauthorized application, the buyer shall indemnify Vishay Semiconductors against all claims, costs, damages, and expenses, arising out of, directly or indirectly, any claim of personal damage, injury or death associated with such unintended or unauthorized use.

Vishay Semiconductor GmbH, P.O.B. 3535, D-74025 Heilbronn, Germany  
Telephone: 49 (0)7131 67 2831, Fax number: 49 (0)7131 67 2423