

	Date		Page	1 - 7
	Specification type			
	SN D-1407B-05			

APPROVAL SHEET FOR PIEZOELECTRIC BUZZER

specification type	SN D-1407B-05
Customer specification type	

Customer	
Customer name/Stamp/Sign/Date	Drawn: 曹小丽
	Checked:
	Approved:

	Date		Page	2 - 7
Specification type				
SND-1407B-05				

Specification for Piezoelectric Buzzer

Type	Unit	SN D - 1407 B - 05
Rated Voltage	V	5
Operating Voltage	V	1.5 ~ 12
*Rated Current (MAX)	mA	≤6
*Min Sound Output at 30cm	dB	≥85
*Resonant Frequency	Hz	4500 ± 500
Operating Temperature	°C	-20 ~ +60
Storage Temperature	°C	-30 ~ +70
Housing Material		ROHS PPO
Weight	g	2.0

(UNIT: mm) Tolerance: ±0.3mm Except Specified
Continuous tone

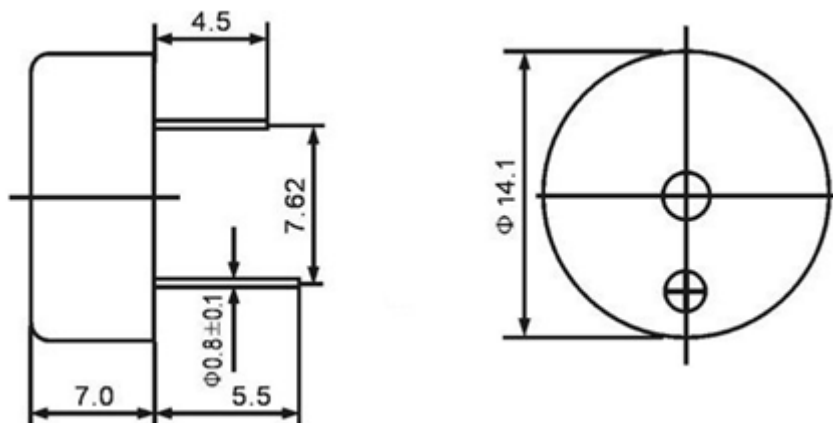

	Date		Page	3 - 7
Specification type				
SN D-1407B-05				

Test Method:

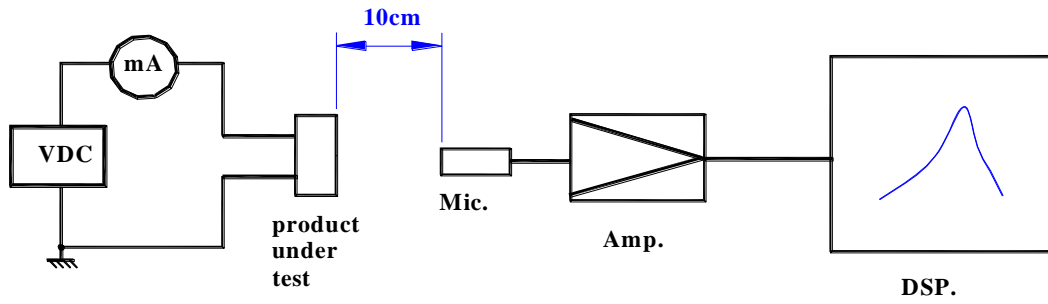

Frequency Response:

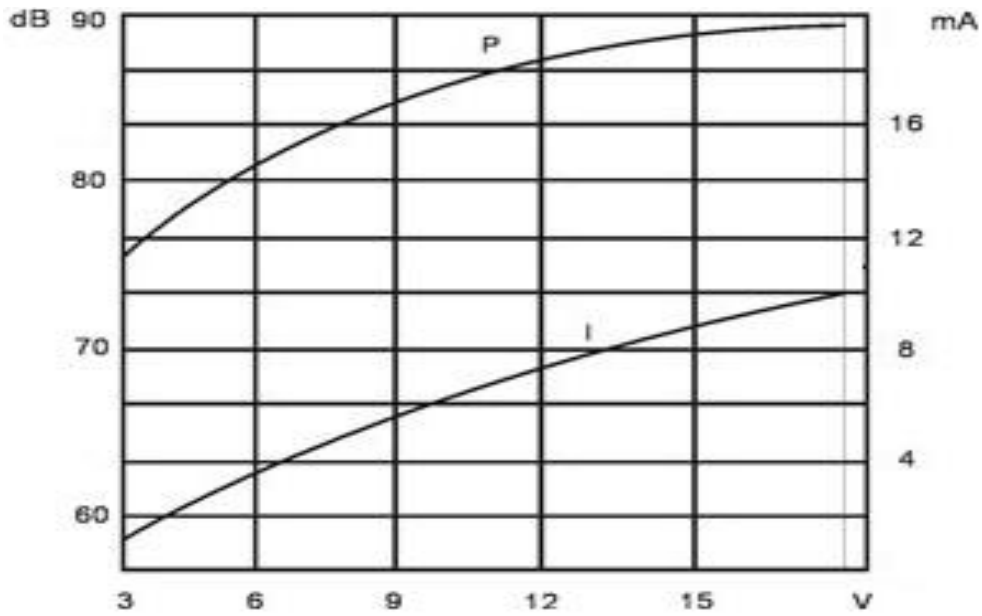

	Date		Page	4 - 7
	Specification type			
	SND-1407B-05			

TEMPERATURE

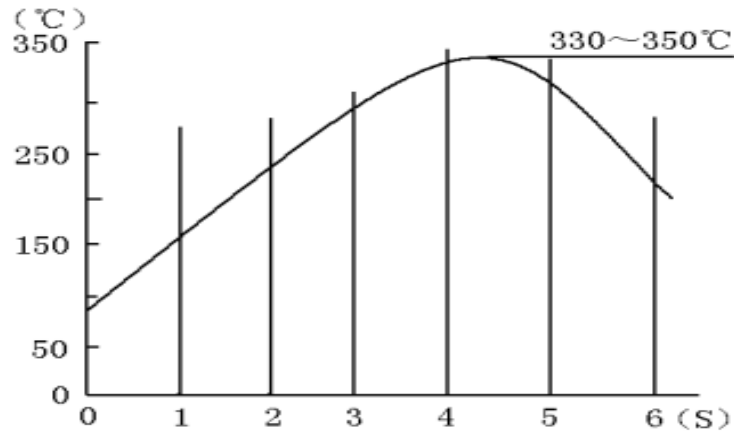

成品辨识资料

化学名称	PPO	高抗冲聚苯乙烯	其它
CAS NO.	25134-01-4	9003-55-8	
含量 (%)	30-85	15-70	<20%

危害性成分

成分	CAS NO.	OSHA	UNIT	ACGIH	U NIT
CARBON BLACK	133-86-4	3.5	mg/m ³ PEL	3.5	mg/m ³ TLV
Aromatic Polyphosphate	139189-30-3	3.0	mg/m ³ PEL	3.0	mg/m ³ TLV

检测依据

测试项目	测试方法	测试仪器	方法未检测限
铅(Pb)	IEC 62321:2008 Ed.1 Sec. 8	ICP-OES	2mg/kg
镉(Cd)	IEC 62321:2008 Ed.1 Sec. 8	ICP-OES	2mg/kg
汞(Hg)	IEC 62321:2008 Ed.1 Sec. 7	ICP-OES	2mg/kg
六价铬(Cr(VI))	IEC 62321:2008 Ed.1 Annex C	UV-Vis	2mg/kg
多溴联苯(PBBs)	IEC 62321:2008 Ed.1 Annex A	GC-MS	5mg/kg
多溴二苯醚(PBDEs)	IEC 62321:2008 Ed.1 Annex A	GC-MS	5mg/kg

	Date		Page	5 - 7
Specification type				
SN D-1407B-05				

Reliability specification

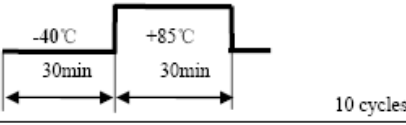
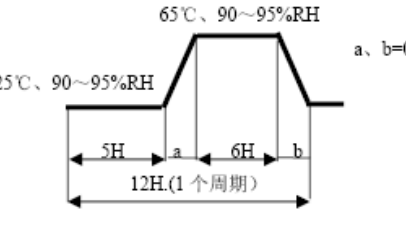
Item	Test condition	Criteria	引用规格
1	High temperature Preservation	Exposure to +85°C for 96 hrs.	After the test the part shall meet specifications without any degradation in appearance And performance except SPL.
2	Low temperature preservation	Exposure to -40°C for 96 hrs.	
3	Thermal Shock		
4	Thermal, Humidity Shock		
5	Ordinary Temp. Life	Driving the sounder at 5VDC for 1000hrs in the room temperature(25°C±10°C)	
6	High Temp. Life	Driving the sounder at 6.5VDC for 500hrs in the low temperature(+85°C)	
7	Low Temp. Life	Driving the sounder at 5VDC for 500hrs in the low temperature(-40°C)	
8	Lead strength	Pull load on the direction of the terminal axis for 10±1 sec.	GB/T 2423.29
9	Vibration	10~55~10Hz Sinewave, Sweep 1 min, Amplitude 1.52mm Max 91m/S ² X,Y,Z 3Direction 2hrs each, Total 6hrs	GB/T 2423.10
10	Free drop	Free drop, 70cm height, on wood board (t40mm) X,Y,Z 3Direction 1time each, total 3times.	Exclude bending of Pin GB/T 2423.8
11	Solder heat resistance	Soldering into solderbath: Solder Temp. 350±10°C Soaking Time: 3.5±0.5sec	After the test the part shall meet specifications without any degradation in appearance and performance GB/T 2423.28
12	Washability	Solvent: deionized water, Solvent temp: 55±5°C Soaking time: 5±0.5minutes	
13	Solderability	Pretreatment: 40°C, 90~95%RH*240hrs Soldering into solderbath: Solder Temp. 360±5°C Soaking Time: 2±0.5sec	95% surface of lead pins must be covered with fresh solder and no soldering holes Should be found GB/T 2423.28

	Date		Page	6 - 7
	Specification type			
	SN D-1407B-05			

Material List

银色金属

银色金属

PCB 板（含其他元器件）

黑色塑料外壳

黑色环氧树脂



检测项目 (Test Item S)	Limit	Unit	MDL
Cd 镉	<100	Mg/kg	2
Pb 铅	<1000	Mg/kg	2
Hg 汞	<1000	Mg/kg	2
Cr(VI) 六价铬	<1000	Mg/kg	2
PBBs 多溴联苯	<1000	Mg/kg	---
PBDEs 多溴联苯醚	<1000	Mg/kg	---

	Date		Page	7 - 7
	Specification type			
	SN D-1407B-05			

PACKING STANDARD

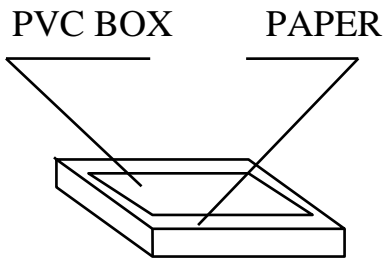

Small box

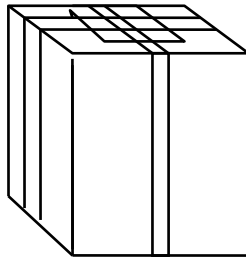

Internal box

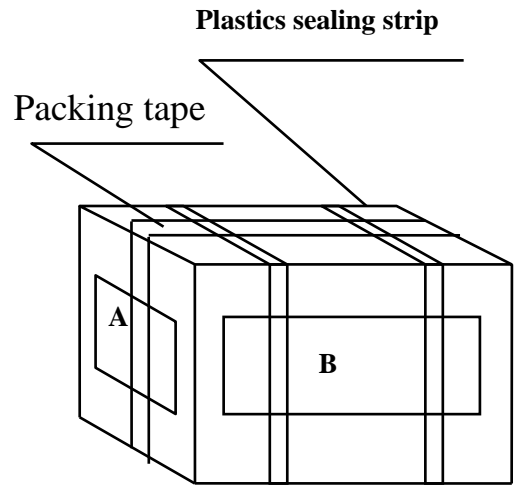

External case