

WiFi/Bluetooth Ceramic Chip Antenna
Model: AA055A
TELA chip antenna
Product Number: H2U34W1H1Z0400

REFERENCE SPECIFICATION

Table of Contents

1	Introduction.....	3
2	Electrical Characteristics	4
2.1	Table with electrical properties:	4
2.2	Return Loss (S_{11})	5
2.3	VSWR (S_{11})	5
2.4	Efficiency Table.....	6
2.5	Efficiency vs. Frequency.....	6
2.6	Radiation Pattern (with 80x40mm ² Evaluation Board).....	7
3	Layout.....	8
3.1	Antenna Dimensions.....	8
3.2	Evaluation Board with Antenna	9
3.3	Solder Land Pattern	10
4	Frequency tuning.....	11
4.1	Reference for frequency tuning element.....	12
5	Packing	13
5.1	Packing process	16
6	Notes	17
6.1	Typical Soldering Profile for Lead-free Process	17
6.2	Operating and storage conditions:	18
6.3	Installation guide:	18
6.4	Reminders for users of Unictron’s AA055A ceramic chip antennas	18

1 Introduction

Unictron's AA055A chip antenna is design for 2.4 GHz applications, covering frequencies 2400 - 2500 MHz. Fabricated with proprietary design and processes, AA055A shows excellent performance and is fully compatible with SMT processes which can decrease the assembly cost and improve the device's quality and consistency.

Features

- * Stable and reliable in performances
- * Low temperature coefficient of frequency
- * Low profile, compact size
- * RoHS compliance
- * SMT processes compatible

Applications

- * ISM 2.4 GHz applications
- * ZigBee/BLE applications
- * Bluetooth earphone systems
- * Hand-held devices when WiFi / Bluetooth functions are needed, e.g., Smart phones
- * IEEE802.11 b/g/n
- * Wireless PCMCIA cards or USB dongles

2 Electrical Characteristics

2.1 Table with electrical properties:

Characteristics		Specifications	Unit
Outline Dimensions		3.2x1.6x0.5	mm
Ground Plane		80x40	mm
Working Frequency		2400~2500	MHz
VSWR (@Center Frequency)*		2 Max.	
Characteristic Impedance		50	Ω
Polarization		Linear Polarization	
Peak Gain	(@2442MHz)	2.5 (typical)	dBi
Efficiency		84 (typical)	%

*Center frequency means the frequency with the lowest value in return loss of the chip antenna on the evaluation board.

2.2 Return Loss (S_{11})

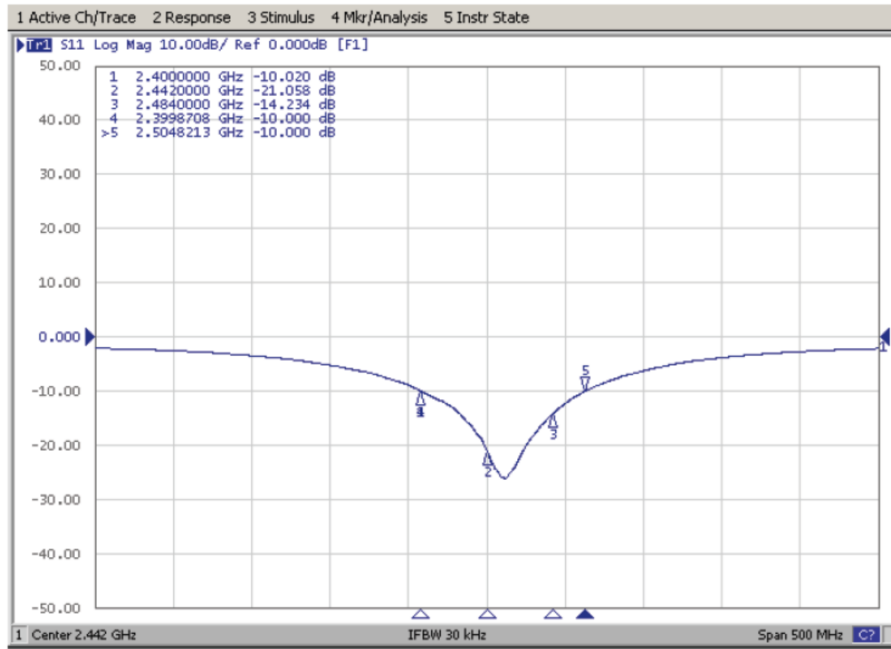

2.3 VSWR (S_{11})

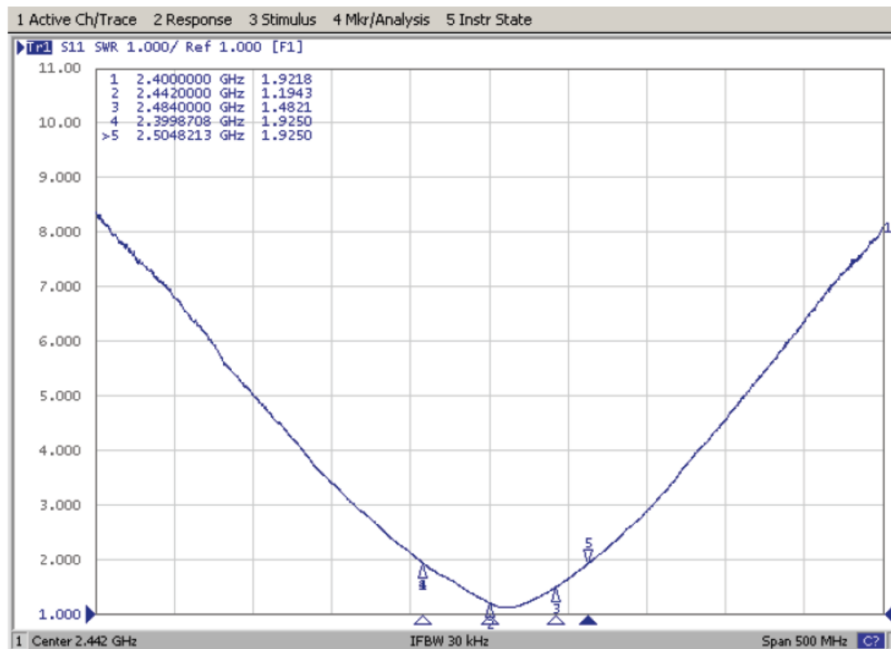

2.4 Efficiency Table

Frequency(MHz)	2400	2412	2417	2422	2427	2432	2437	2442	2447	2452	2457	2462	2467	2472	2484	2500
Efficiency(dB)	-1.4	-1.0	-0.9	-0.8	-0.8	-0.8	-0.7	-0.7	-0.8	-0.8	-0.8	-0.9	-0.9	-1.0	-1.2	-1.4
Efficiency(%)	72.8	78.7	80.4	82.3	83.0	83.9	84.4	84.5	84.1	84.0	83.2	82.0	80.5	78.6	75.4	72.5
Peak Gain(dBi)	1.5	1.8	1.9	2.1	2.3	2.3	2.4	2.5	2.5	2.5	2.4	2.4	2.2	2.1	1.9	1.8

2.5 Efficiency vs. Frequency

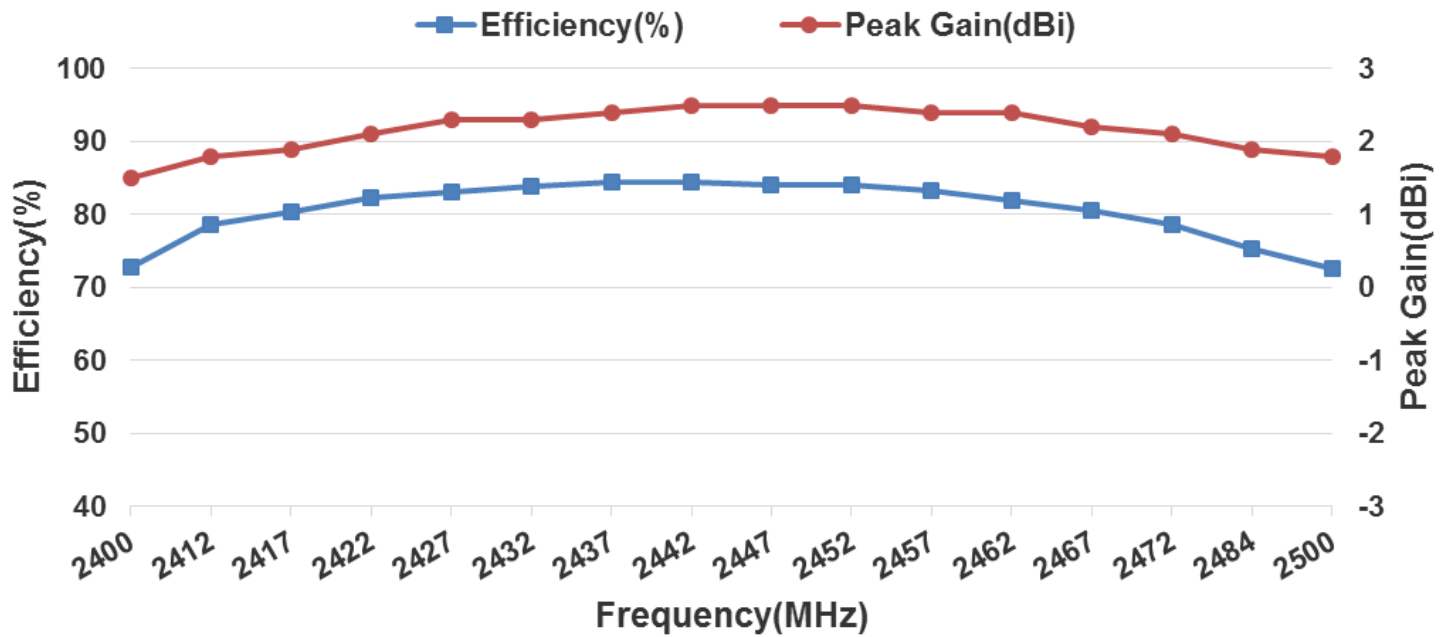

2.6 Radiation Pattern (with 80x40mm² Evaluation Board)

3D Gain Pattern @ 2442 MHz (unit: dBi)

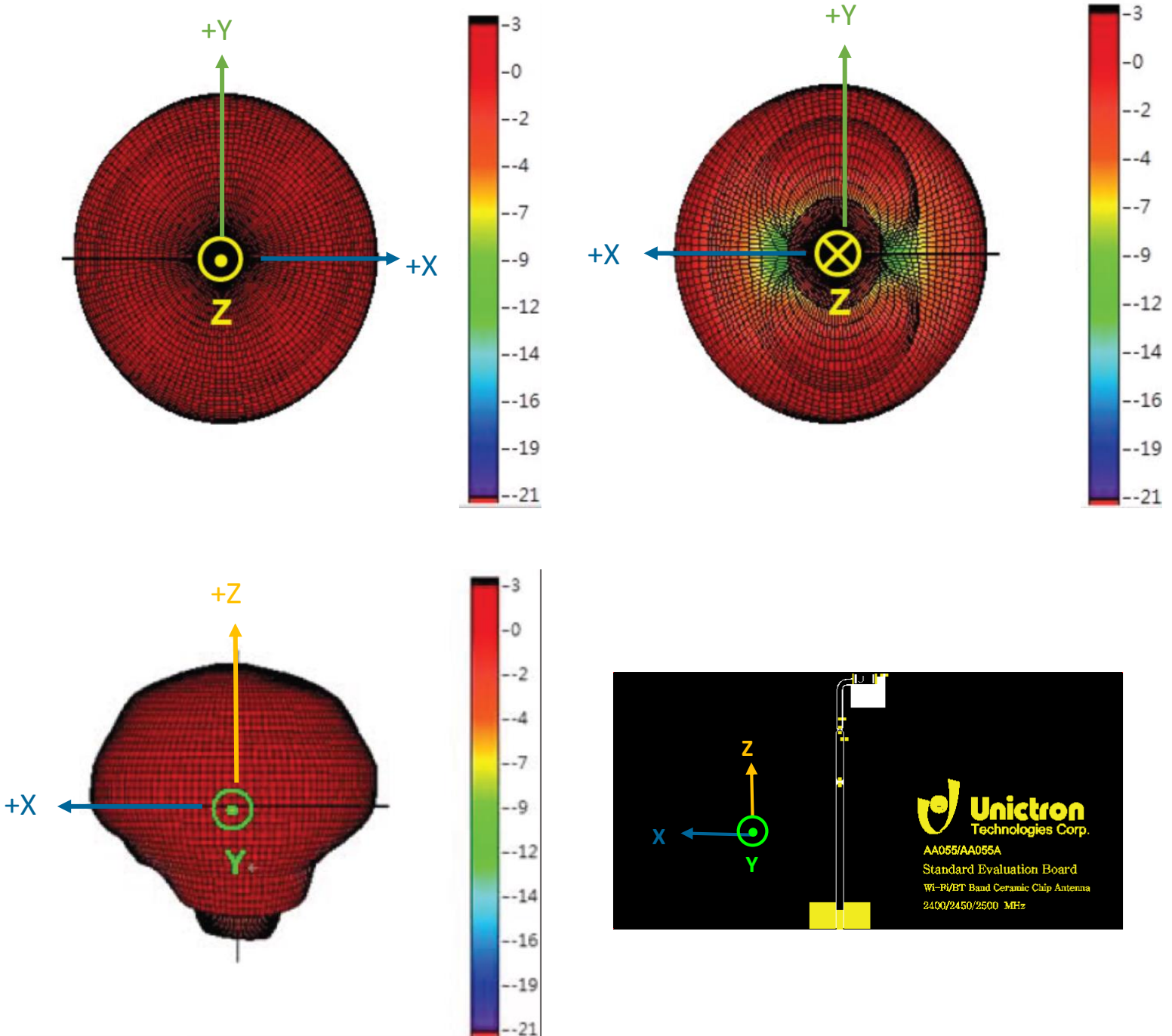

3 Layout

3.1 Antenna Dimensions

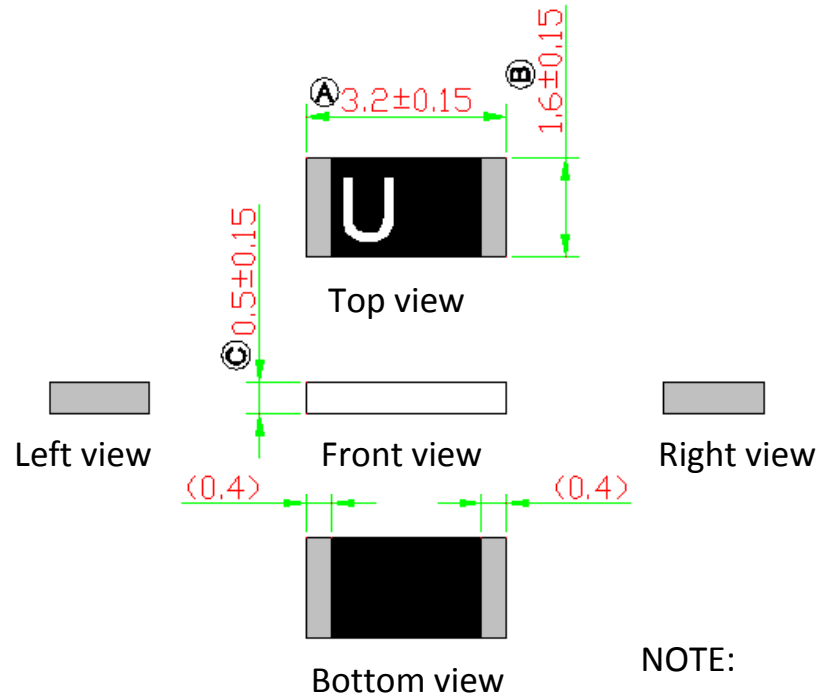

Unit: mm

NOTE:

1. All materials are RoHS compliant
2. "A - C" Critical dimensions
3. "()" Reference dimensions

PIN Definitions



PIN	PIN1	PIN 2
Soldering pad	Signal	Tuning/Ground

3.2 Evaluation Board with Antenna

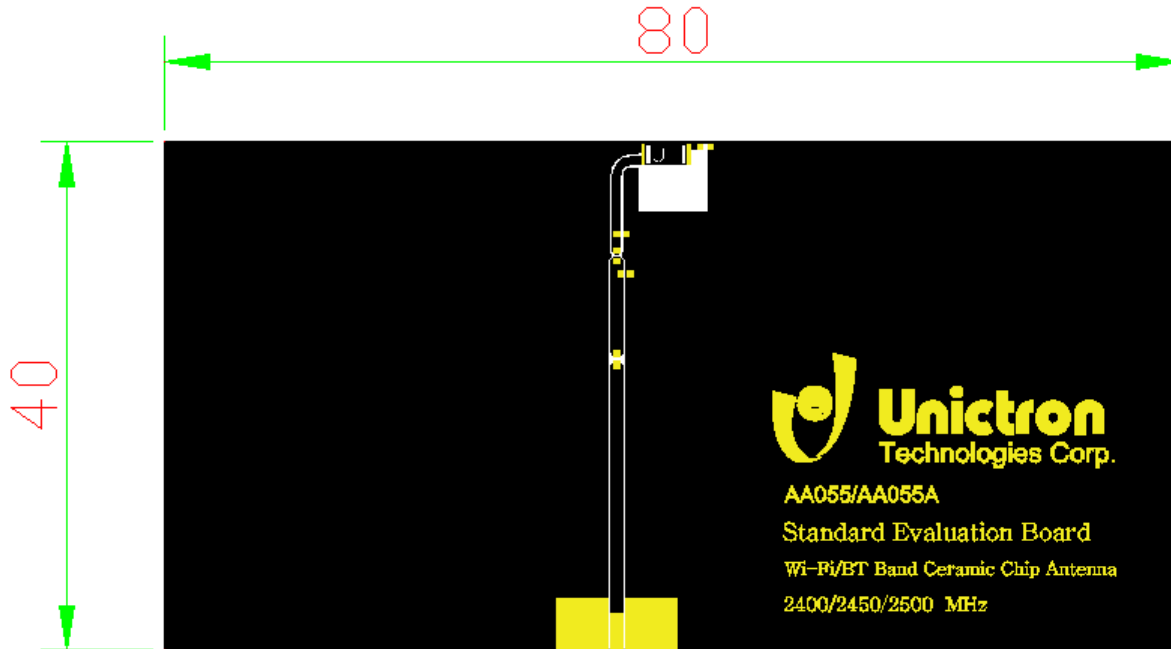

Unit: mm

3.3 Solder Land Pattern

The solder land pattern (gold marking areas) is shown below. Recommendation on matching circuit will be provided according to customer's installation conditions.

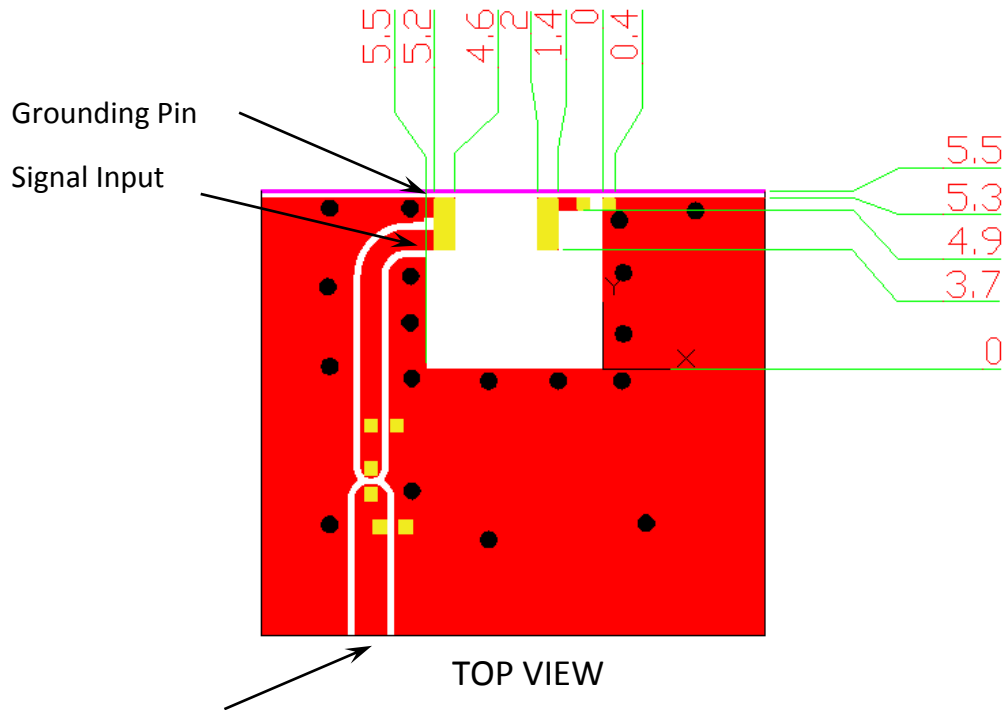

Transmission line with 50 Ohm impedance characteristics.

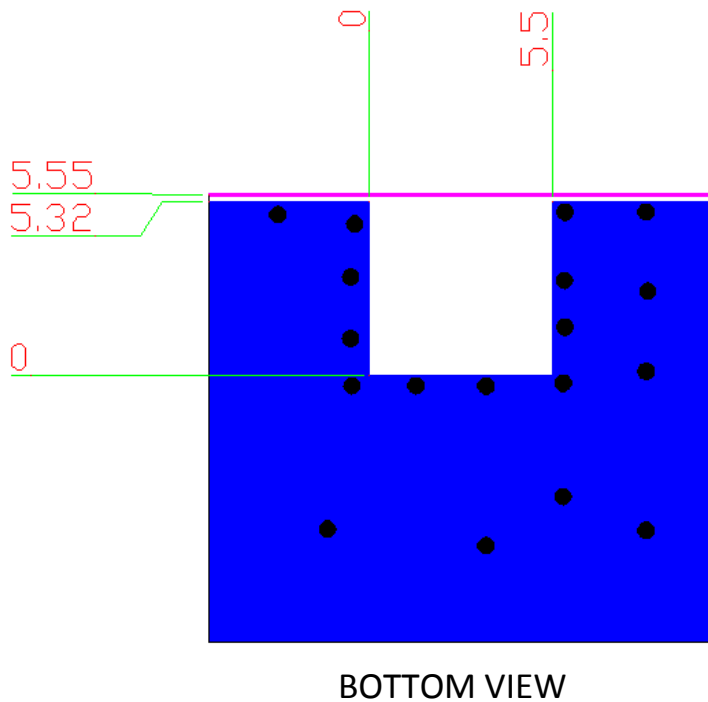

4 Frequency tuning

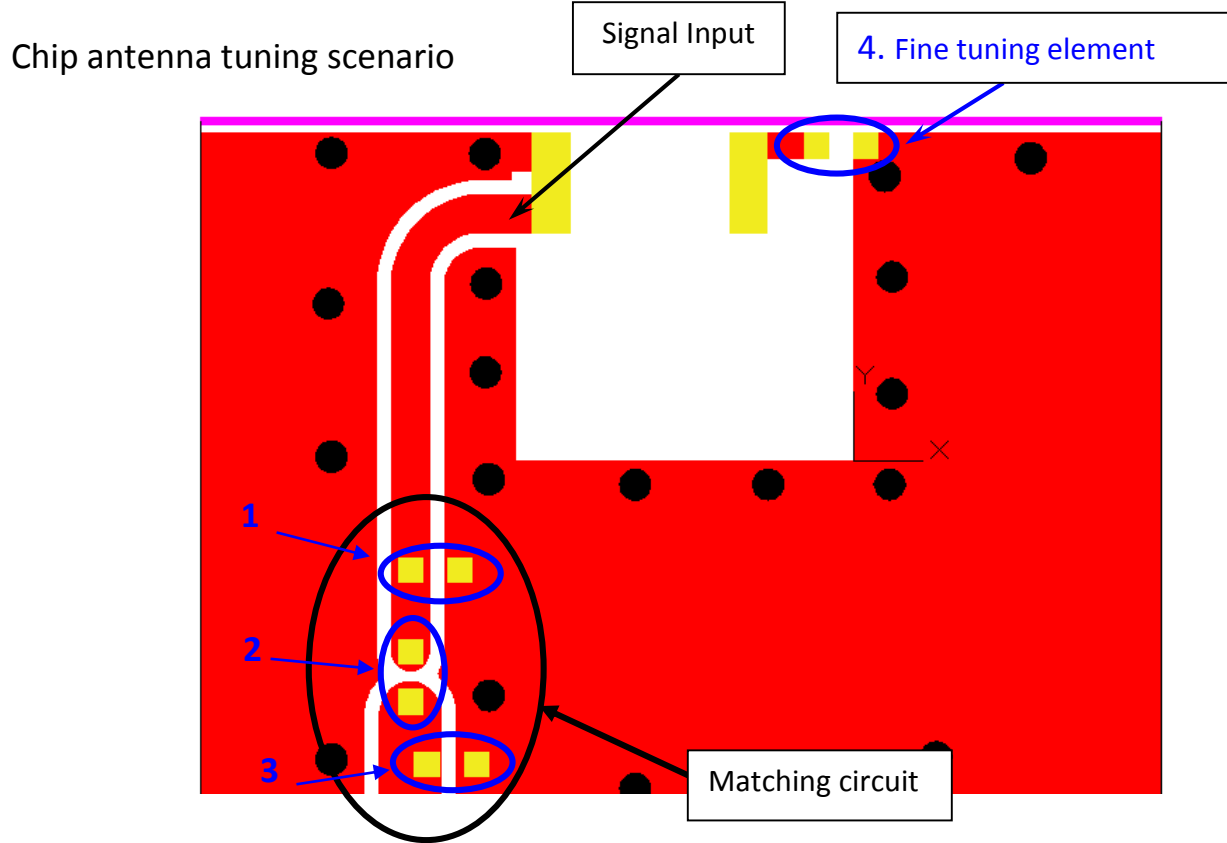

With the following recommended values of matching and tuning components, the center frequencies will be about 2442 MHz at out standard 80x40 mm² evaluation board. However, these are typical reference values which may need to be changed when circuit boards or part vendors are different.

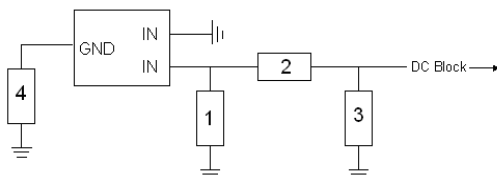

System Matching Circuit Component			
Location	Description	Vendor	Tolerance
1	1.2 pF (0402)	DARFON	±0.1 pF
2	3.3nH (0402)	DARFON	±0.1 nH
3	N/A	-	-
4 Fine tuning element	1.5 pF (0402)	DARFON	± 0.1 pF

4.1 Reference for frequency tuning element

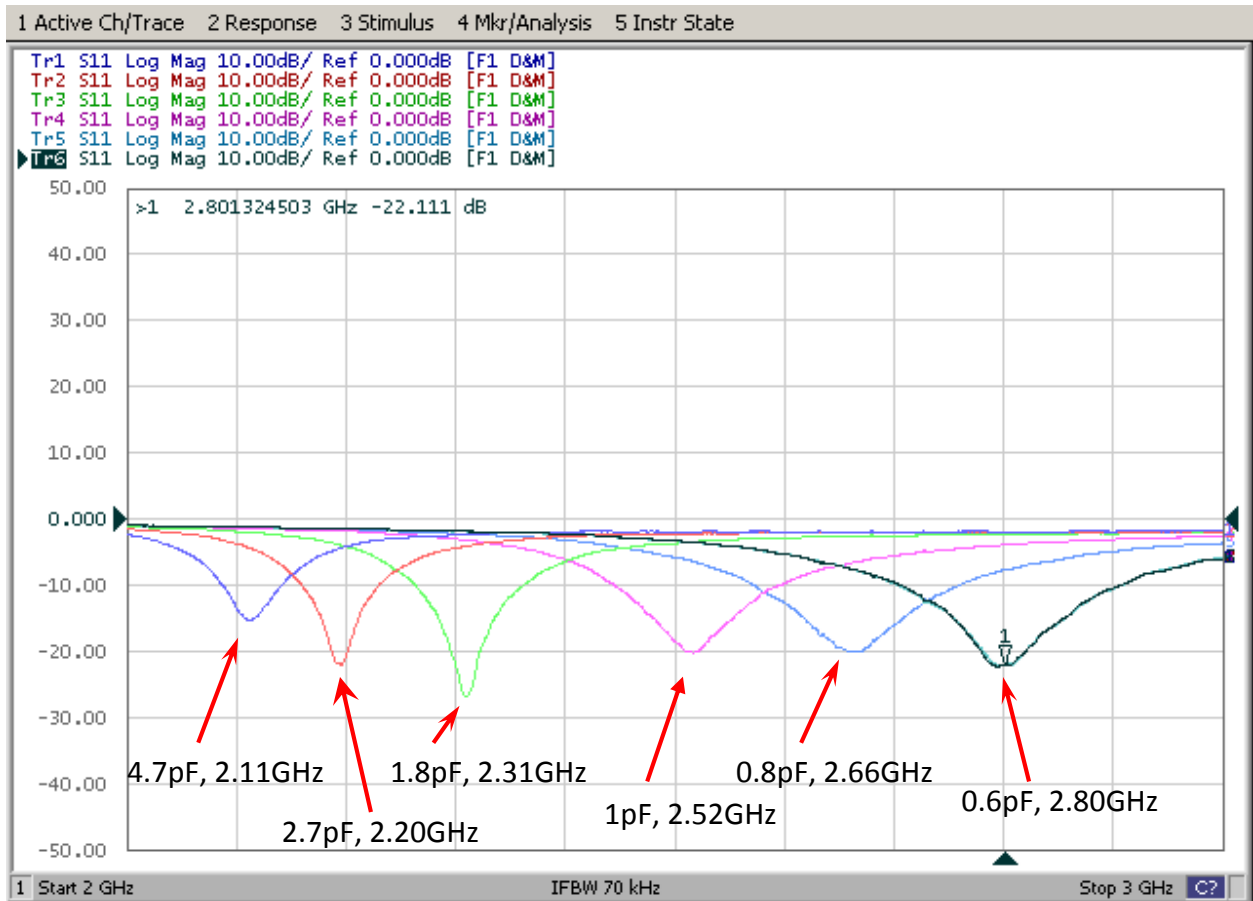
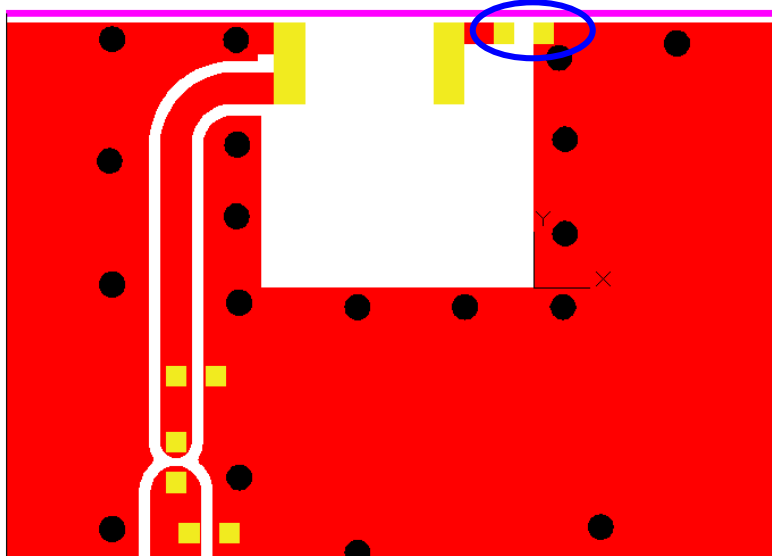

5 Packing

1. Quantity/Reel: 5000 pcs/Reel
2. Plastic tape:

a) Tape drawing:

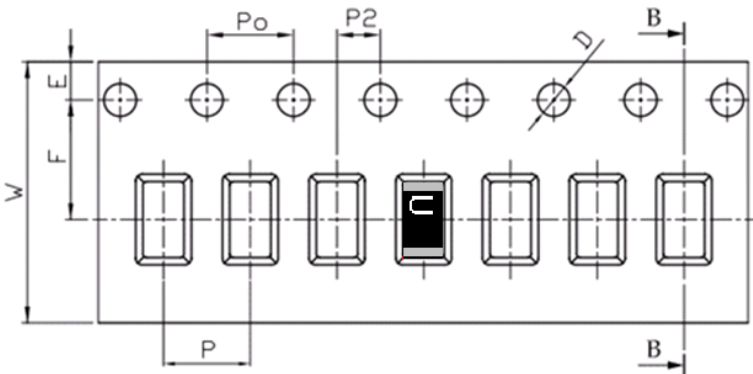

b) Tape dimensions (unit: mm)

Feature	Specifications	Tolerances
W	12.00	±0.30
P	4.00	±0.10
E	1.75	±0.10
F	5.50	±0.10
P2	2.00	±0.10
D	1.50	+0.10 -0.00
Po	4.00	±0.10
10Po	40.00	±0.20

c) Reel Drawing:

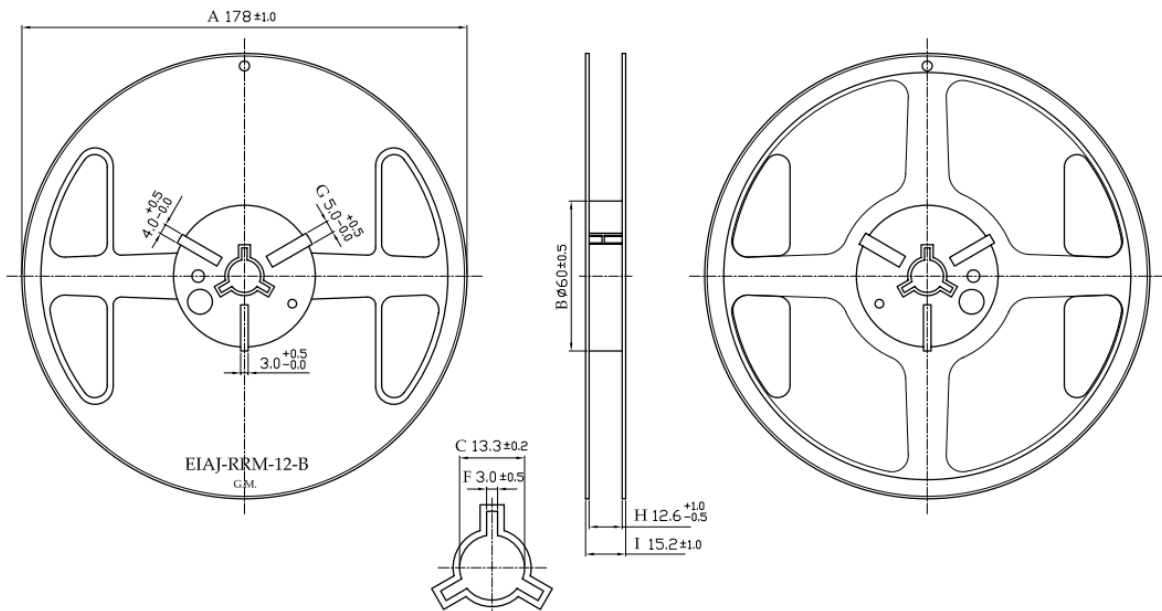

d) Drawing of small size carton in developed view

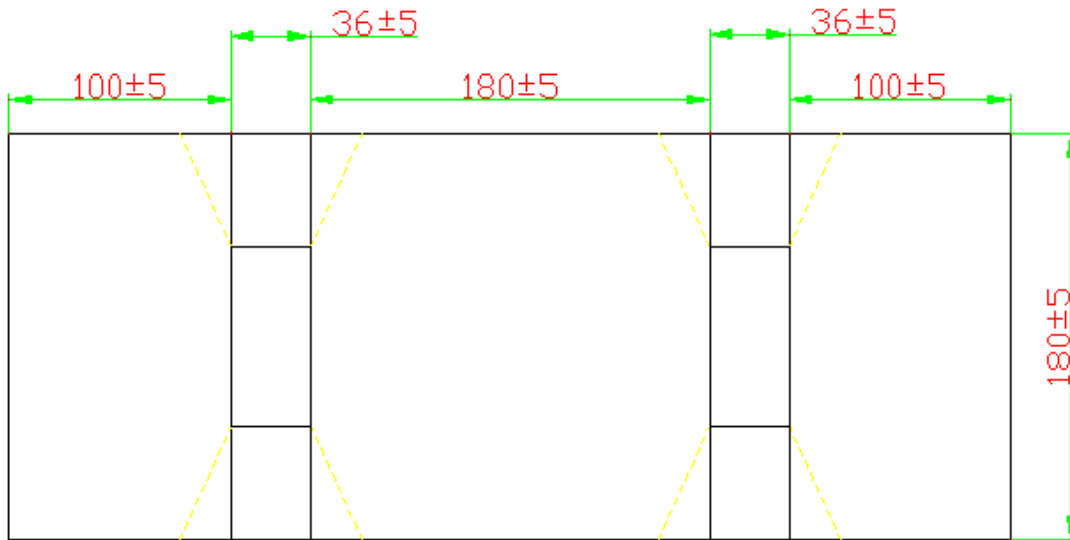

e) Drawing of middle size carton in developed view

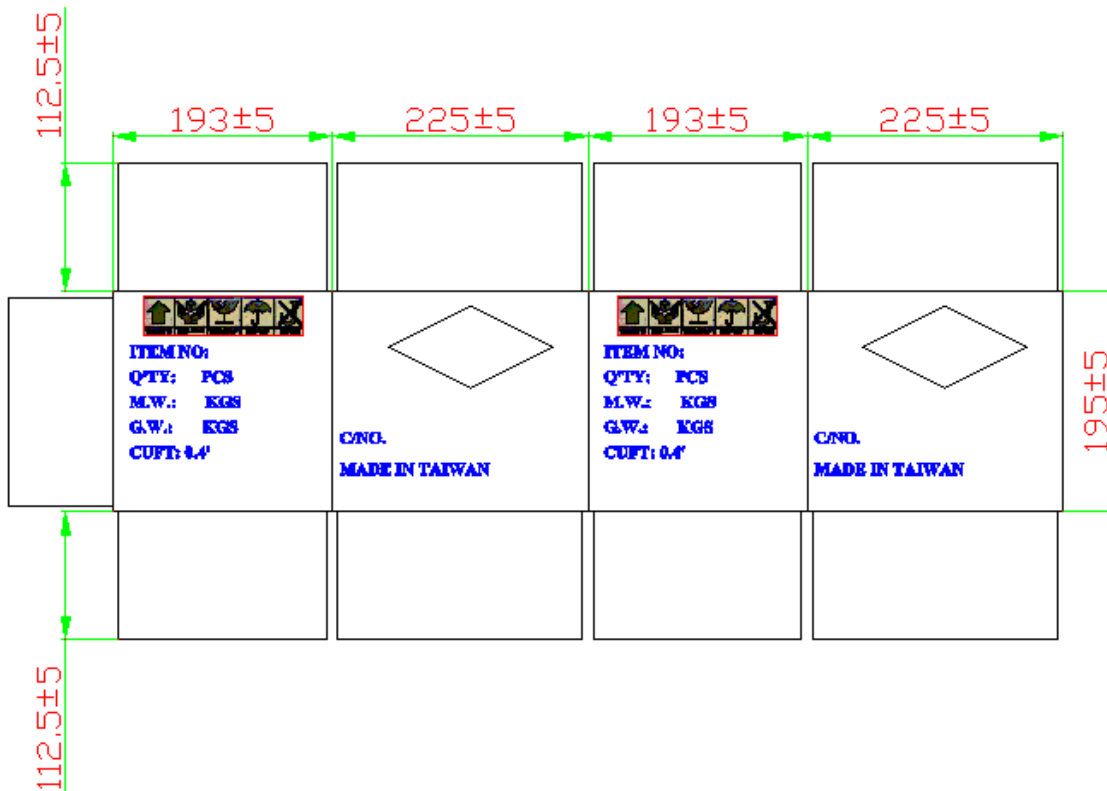

f) Drawing of large size carton in developed view

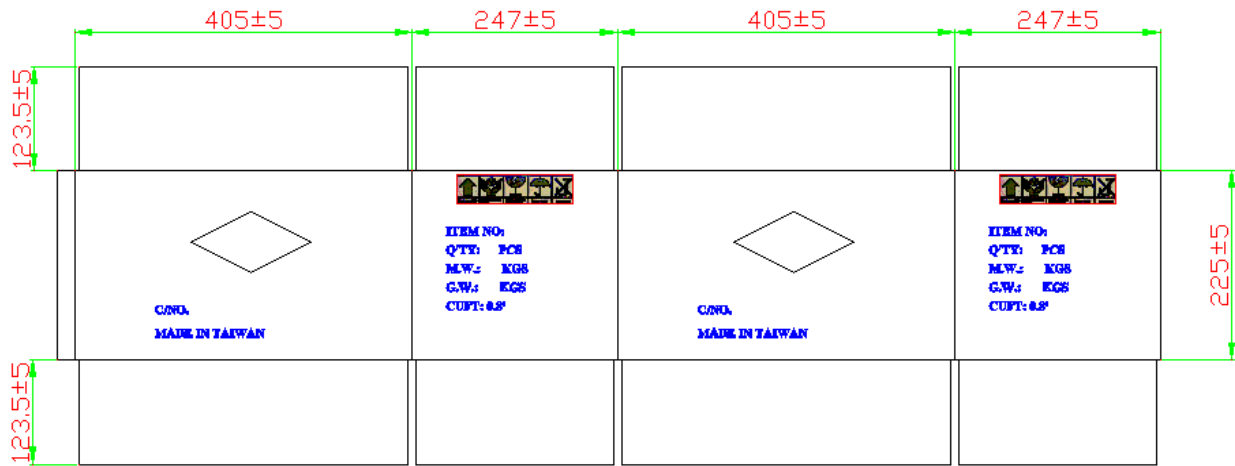

g) Picture of the label

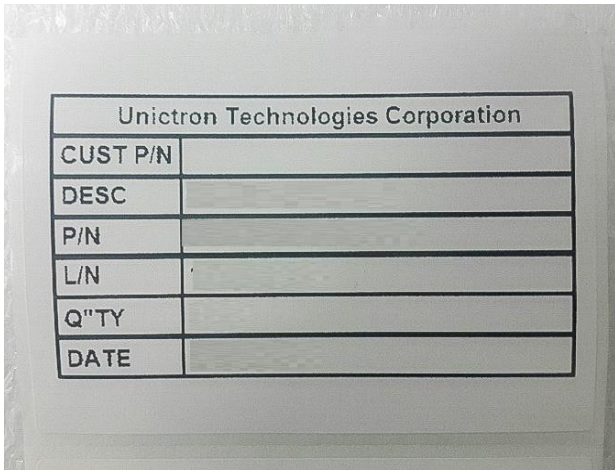

h) Reel with the label



i) Small size carton with the label

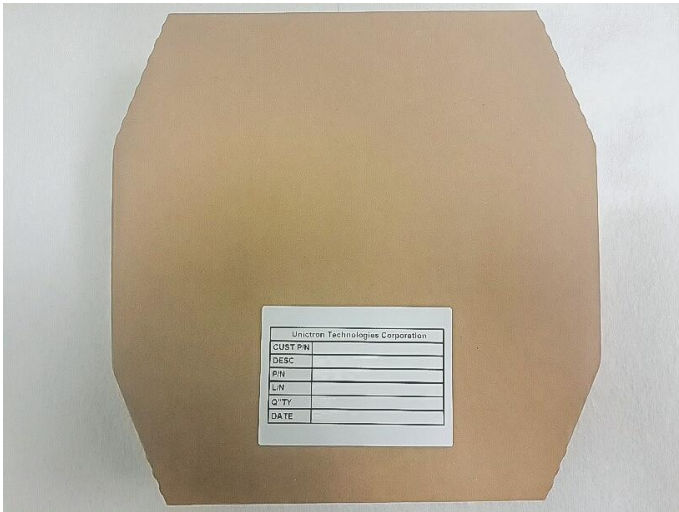

j) Middle size carton with the label



5.1 Packing process

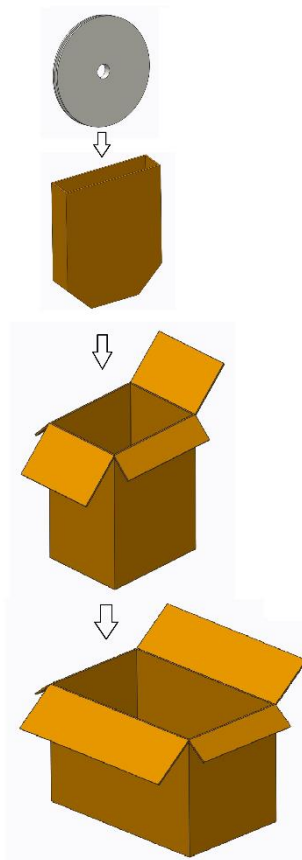

1 reel includes max 5000 pieces chip antennas

1 small size carton includes max 2 reels

1 middle size carton includes max 5pcs of small carons

1 large size carton includes max 2 pcs of middle size cartons

6 Notes

6.1 Typical Soldering Profile for Lead-free Process

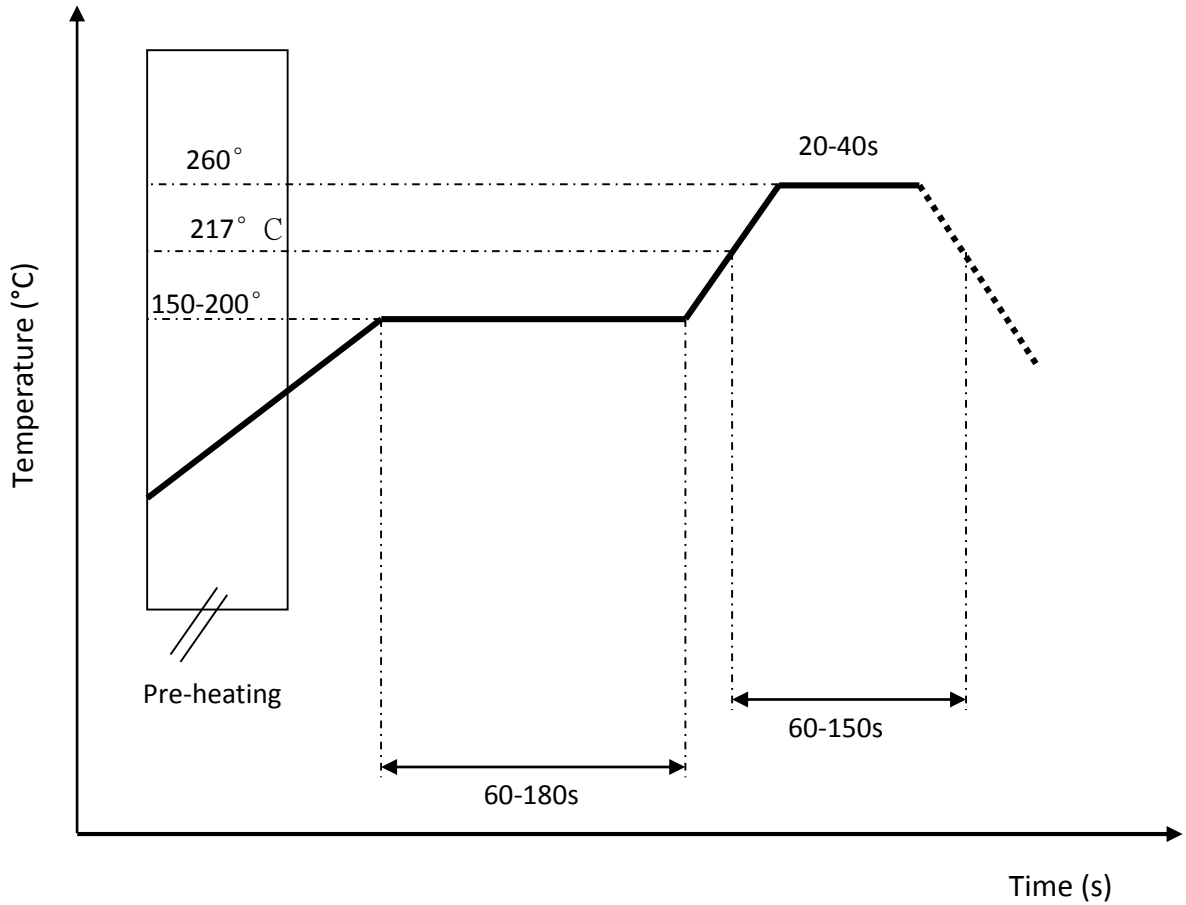

6.2 Operating and storage conditions:

Operating:

Maximum Input Power: 2W

Operating Temperature: -40 C to 85 C

Storage:

Storage Temperature -5C to 40 C

Relative Humidity: 20% to 70%

Shelf Life: 1 year

6.3 Installation guide:

Request Unictron's application notes "General guidelines for the installation of Unictron's chip antennas" for further information at e-sales@unictron.com.

6.4 Reminders for users of Unictron's AA055A ceramic chip antennas

- 6.4.1. This chip antenna is made of ceramic materials which are relatively more rigid and brittle compared to printed circuit board materials. Bending of circuit board at the locations where chip antenna is mounted may cause the cracking of solder joints or antenna itself.
- 6.4.2. Punching/cutting of the break-off tab of PCB panel may cause severe bending of the circuit board which may result in cracking of solder joints or chip antenna itself. Therefore break-off tab shall be located away from the installation site of chip antenna.
- 6.4.3. Be cautious when ultrasonic welding process needs to be used near the locations where chip antennas are installed. Strong ultrasonic vibration may cause the cracking of chip antenna solder joints.

Presented data were measured on reference PCB (ground) as shown in this specification. When the antenna placement or size of the PCB is changed, antenna performance and values of matching components may differ from data shown here.

Information presented in this Reference Specification is believed to be correct as of the date of publishing. Unictron Technologies Corporation reserves the rights to change the Reference Specification without notice due to technical improvements, etc. Please consult with Unictron's engineering team about the latest information before using this product. Per request, we may provide advice and assistance in implementing this antenna to a customer's device by simulation or real measurement of the interested device in our testing facilities.

Unictron Technologies Corporation

No. 41 Shuei-Keng, Guan-Si

Hsinchu 30648

Taiwan (R.O.C.)

Tel: +886-3-547-5550

Email: e-sales@unictron.com

Web: www.unictron.com