



# SX1276/SX1278 Wireless Modules

## E32 Series

### User Manual

This manual may be modified based on product upgrade, please refer to the latest version.  
All rights to interpret and modify this manual belong to Chengdu Ebyte Electronic Technology Co., Ltd.

Version	Date	Description	Issued by
1.00	2017/11/10	Initial version	huaa
1.10	2018/01/11	Added E32 (868T30S)/E32 (915T30S)	huaa
1.20	2018/01/15	Added E32 (868T20S)/E32 (915T20S)/E32 (400T20S)	huaa
1.30	2018/01/22	Added E32 (868T20D)/E32 (868T30D)/E32 (915T20D)/E32 (915T30D)/E32 (170T30D)	huaa

## Brief Introduction

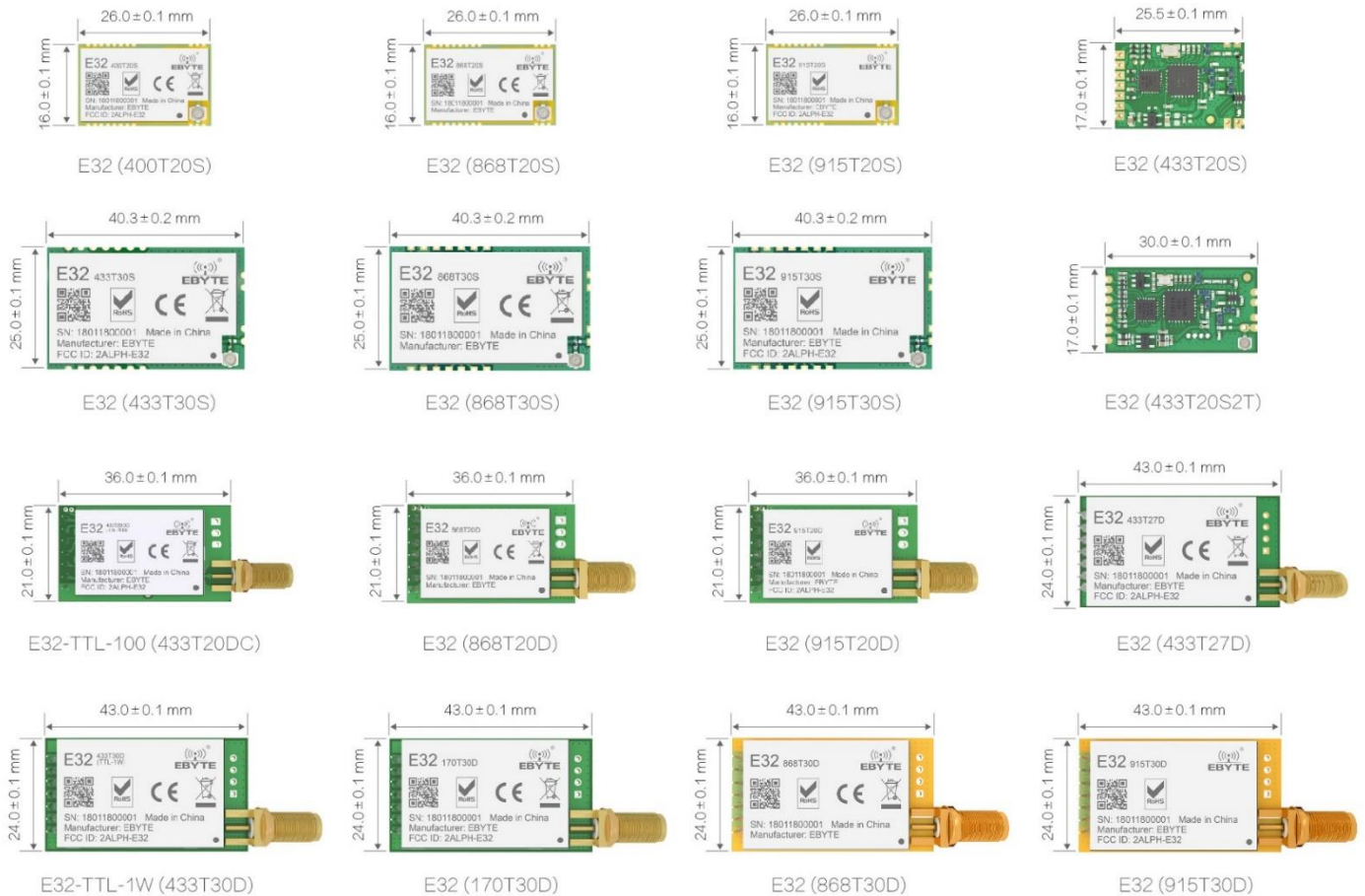

E32 series are UART wireless modules based on SX1276/SX1278 RF IC of SEMTECH with transparent transmission and LoRa spread spectrum technology. The modules 3.3V TTL output. SX1276/SX1278 support LoRa™ technology, The LoRa™ DSSS (direct sequence spread spectrum) technology features long range and strong anti-interference as well as strong data confidentiality. SX1276/SX1278 are considered as a milestone in terms of low speed data communication.

The modules of 30dBm transmitting power are embedded with power amplifier (PA) and low noise amplifier (LNA), which enhances the stability and longer communication range; the modules of 20dBm transmitting power adopt industrial grade crystal oscillators to ensure the stability and consistency, its precision is lower than the widely adopted 10ppm. E32 series are in stable bulk production and are widely applied in utility meters, IoT renovation, smart home, etc. The modules feature data encryption and compression. The data transmitted in air features randomness. The encryption-decryption algorithm makes data interception

meaningless. And the data compression enables shorter transmitting time and lower rate of being interfered, which increased the reliability and transmitting efficiency.

E32 series strictly follow FCC, CE, CCC and such design standards and meet various RF certification requirements for exporting.

Model	Frequency	TX Power	Range	Packing	Antenna
E32 (433T20DC)	433M	20dBm	3000m	DIP	SMA-K
E32 (433T20S)	433M	20dBm	3000m	SMD	Spring
E32 (433T20S2T)	433M	20dBm	3000m	SMD	IPEX/Spring
E32 (433T27D)	433M	27dBm	5000m	DIP	SMA-K
E32 (433T30D)	433M	30dBm	8000m	DIP	SMA-K
E32 (433T30S)	433M	30dBm	8000m	SMD	IPEX/Spring
E32 (868T20D)	868M	20dBm	3000m	DIP	SMA-K
E32 (868T20S)	868M	20dBm	3000m	SMD	IPEX/Spring
E32 (868T30D)	868M	30dBm	8000m	DIP	SMA-K
E32 (868T30S)	868M	30dBm	8000m	SMD	IPEX/Spring
E32 (915T20D)	915M	20dBm	3000m	DIP	SMA-K
E32 (915T20S)	915M	20dBm	3000m	SMD	IPEX/Spring
E32 (915T30D)	915M	30dBm	8000m	DIP	SMA-K
E32 (915T30S)	915M	30dBm	8000m	SMD	IPEX/Spring
E32 (170T30D)	170M	30dBm	8000m	DIP	SMA-K
E32 (400T20S)	470M	20dBm	3000m	SMD	IPEX/Spring

**Contents**

<b>CONTENTS</b> .....	<b>3</b>
<b>1. FEATURES</b> .....	<b>5</b>
<b>2. TECHNICAL PARAMETERS</b> .....	<b>6</b>
2.1. GENERAL PARAMETERS.....	6
2.2. ELECTRICAL PARAMETERS .....	7
2.2.1. <i>Transmitting current</i> .....	7
2.2.2. <i>Receiving current</i> .....	7
2.2.3. <i>Turn-off current</i> .....	8
2.2.4. <i>Voltage supply</i> .....	8
2.2.5. <i>Communication level</i> .....	9
2.3. RF PARAMETERS .....	9
2.3.1. <i>Transmitting power</i> .....	9
2.3.2. <i>Receiving sensitivity</i> .....	10
2.3.3. <i>Recommended working frequency</i> .....	10
2.4. TESTED RANGE .....	11
<b>3. MECHANICAL CHARACTERISTICS</b> .....	<b>12</b>
3.1. E32 (433T20DC)/ E32 (915T20D)/ E32 (868T20D).....	12
3.1.1. <i>Dimension</i> .....	12
3.1.2. <i>Pin definitions</i> .....	12
3.2. E32 (433T20S).....	13
3.2.1. <i>Dimension</i> .....	13
3.2.2. <i>Pin definitions</i> .....	13
3.3. E32 (433T20S2T).....	14
3.3.1. <i>Dimension</i> .....	14
3.3.2. <i>Pin definitions</i> .....	14
3.4. E32 (433T27D) / E32-TTL-1W (433T30D) / E32 (915T30D)/ E32 (868T30D)/ E32 (170T30D).....	15
3.4.1. <i>Dimension</i> .....	15
3.4.2. <i>Pin definitions</i> .....	15
3.5. E32 (433T30S)/ E32 (868T30S)/ E32 (915T30S) .....	16
3.5.1. <i>Dimension</i> .....	16
3.5.2. <i>Pin definitions</i> .....	16
3.6. E32 (400T20S)/ E32 (868T20S)/ E32 (915T20S) .....	17
3.6.1. <i>Dimension</i> .....	17
3.6.2. <i>Pin definitions</i> .....	17
<b>4. RECOMMENDED CIRCUIT DIAGRAM</b> .....	<b>18</b>
<b>5. FUNCTION DESCRIPTION</b> .....	<b>18</b>
5.1. FIXED MODE .....	18
5.2. BROADCAST MODE.....	19
5.3. BROADCAST ADDRESS.....	19
5.4. MONITORING ADDRESS .....	19
5.5. MODULE RESET.....	19
5.6. AUX DESCRIPTION .....	19
5.6.1. <i>Indication of UART output</i> .....	19
5.6.2. <i>Indication of wireless transmission</i> .....	20
5.6.3. <i>Module in configuration process</i> .....	20
5.6.4. <i>Notes for AUX</i> .....	20
<b>6. OPERATION MODE</b> .....	<b>21</b>

6.1.	MODE SWITCH .....	21
6.2.	NORMAL MODE (MODE 0) .....	22
6.3.	WAKE-UP MODE (MODE 1) .....	22
6.4.	POWER-SAVING MODE (MODE 2) .....	22
6.5.	SLEEP MODE (MODE 3) .....	23
<b>7.</b>	<b>COMMAND FORMAT .....</b>	<b>23</b>
7.1.	DEFAULT PARAMETERS .....	23
7.1.1.	<i>Operating frequency 433MHz:</i> .....	23
7.1.2.	<i>Operating frequency 470MHz:</i> .....	24
7.1.3.	<i>Operating frequency 868MHz:</i> .....	24
7.1.4.	<i>Operating frequency 915MHz:</i> .....	24
7.1.5.	<i>Operating frequency 915MHz:</i> .....	25
7.2.	READING OPERATING PARAMETERS .....	25
7.3.	READING VERSION NUMBER .....	25
7.4.	RESET COMMAND .....	25
7.5.	PARAMETER SETTING COMMAND .....	26
<b>8.</b>	<b>PARAMETER SETTING.....</b>	<b>28</b>
<b>9.</b>	<b>PRODUCTION GUIDANCE.....</b>	<b>29</b>
9.1.	REFLOW SOLDERING TEMPERATURE.....	29
9.2.	REFLOW SOLDERING CURVE.....	29
<b>10.</b>	<b>FAQ .....</b>	<b>30</b>
10.1.	COMMUNICATION RANGE IS TOO SHORT .....	30
10.2.	MODULE IS EASY TO DAMAGE .....	30
<b>11.</b>	<b>IMPORTANT DECLARATIONS.....</b>	<b>30</b>
<b>12.</b>	<b>ABOUT US .....</b>	<b>30</b>

# 1. Features

- **LoRa:**

The LoRa spread-spectrum means the transmitting distance is much longer than before. Confidentiality is high and the possibility of being intercepted is extremely low. Strong ability of anti-interference, which has a strong inhibitory capacity for the Co-Channel Interference and all kinds of noises, and with excellent performance of anti-multipath fading.

- **Ultra-low power consumption:**

It supports WOR to reduce overall power consumption. In power-saving mode (Mode 2), it can regulate overall power consumption by setting receiving response delay; The maximum receiving response delay can be configured as 2000ms, and the average current is about 30uA.

- **Fixed transmission:**

Module can communicate with other modules which work in different channels and addresses, it is easy for networking and repeater. For example: module A transmits AA BB CC to module B (address: 0x00 01, channel: 0x80), HEX format is 00 01 80 AA BB CC (00 01 refers to the address of module B, 80 refers to the channel of module B), then module B receives AA BB CC (only module B).

- **Broadcast transmission:**

Set the module address as 0xFFFF, then the module can communicate with other modules in same channel.

- **FEC:**

Forward Error Correction, high coding efficiency & good correction performance. In the case of sudden interference, it can correct the interfered data packets proactively, so that the reliability & transmission range are improved correspondingly. Without FEC, those data packets can only be dropped.

- **Sleep mode:**

When the module works in sleep mode (mode 3), transmitting & receiving is not available, while the configuration is available. The typical current is 6.0uA in this mode.

- **Watchdog:**

Module with a built-in watchdog, layout and precise time, once an exception occurs, the module will restart in 0.107 seconds, and will continue to work on the previous parameter Settings.

- **Parameter saving:**

The parameters will be saved after setting and won't be lost when powers-off. After power-up again, modules work as the previous parameters.

- **Meter reading:**

E32 (400T20S) is optimized specifically for meter reading data logging, it supports super wide operating frequency with corresponding antenna, it also supports 197-Byte large data packet transmission.

## 2. Technical parameters

### 2.1. General parameters

Model	Core IC	Size	Net weight	Operating temperature	Operating humidity	Storage temperature
E32-TTL-100 (433T20DC)	SX1278	21 * 36 mm	6.7±0.1g	-40 ~ 85°C	10% ~ 90%	-40 ~ 125°C
E32 (433T20S)	SX1278	17*25.5mm	1.6±0.1g	-40 ~ 85°C	10% ~ 90%	-40 ~ 125°C
E32 (433T20S2T)	SX1278	17 * 30 mm	1.6±0.1g	-40 ~ 85°C	10% ~ 90%	-40 ~ 125°C
E32 (433T27D)	SX1278	24 * 43 mm	8.2±0.1g	-40 ~ 85°C	10% ~ 90%	-40 ~ 125°C
E32-TTL-1W (433T30D)	SX1278	24 * 43 mm	8.2±0.1g	-40 ~ 85°C	10% ~ 90%	-40 ~ 125°C
E32 (433T30S)	SX1278	25*40.5mm	5.2±0.1g	-40 ~ 85°C	10% ~ 90%	-40 ~ 125°C
E32 (868T20D)	SX1276	21 * 36 mm	6.7±0.1g	-40 ~ 85°C	10% ~ 90%	-40 ~ 125°C
E32 (868T20S)	SX1276	16 * 26mm	2.1±0.1g	-40 ~ 85°C	10% ~ 90%	-40 ~ 125°C
E32 (868T30D)	SX1276	24 * 43 mm	8.2±0.1g	-40 ~ 85°C	10% ~ 90%	-40 ~ 125°C
E32 (868T30S)	SX1276	25*40.5mm	5.3±0.1g	-40 ~ 85°C	10% ~ 90%	-40 ~ 125°C
E32 (915T20D)	SX1276	21 * 36 mm	6.7±0.1g	-40 ~ 85°C	10% ~ 90%	-40 ~ 125°C
E32 (915T20S)	SX1276	16 * 26mm	2.1±0.1g	-40 ~ 85°C	10% ~ 90%	-40 ~ 125°C
E32 (915T30D)	SX1276	24 * 43 mm	8.2±0.1g	-40 ~ 85°C	10% ~ 90%	-40 ~ 125°C
E32 (915T30S)	SX1276	25*40.5mm	5.3±0.1g	-40 ~ 85°C	10% ~ 90%	-40 ~ 125°C
E32 (170T30D)	SX1278	24 * 43 mm	8.2±0.1g	-40 ~ 85°C	10% ~ 90%	-40 ~ 125°C
E32 (400T20S)	SX1278	16 * 26mm	2.0±0.1g	-40 ~ 85°C	10% ~ 90%	-40 ~ 125°C

Model	Channel (DEC)	Default Chanel (DEC)	Module Address (DEC)	Air Data Rate (kbps)	Flash (Byte)	Sub-Packet (Byte)
E32 (433T20DC)	32	23	65535	Can be configured to 0.3, 1.2, 2.4 (default), 4.8, 9.6, 19.2	512	58
E32 (433T20S)	32	23	65535	Can be configured to 0.3, 1.2, 2.4 (default), 4.8, 9.6, 19.2	512	58
E32 (433T20S2T)	32	23	65535	Can be configured to 0.3, 1.2, 2.4 (default), 4.8, 9.6, 19.2	512	58
E32 (433T27D)	32	23	65535	Can be configured to 0.3, 1.2, 2.4 (default), 4.8, 9.6, 19.2	512	58
E32 (433T30D)	32	23	65535	Can be configured to 0.3, 1.2, 2.4 (default), 4.8, 9.6, 19.2	512	58
E32 (433T30S)	32	23	65535	Can be configured to 0.3, 1.2, 2.4 (default), 4.8, 9.6, 19.2	512	58
E32 (868T20D)	32	6	65536	Can be configured to 0.3, 1.2, 2.4 (default), 4.8, 9.6, 19.2	512	58
E32 (868T20S)	32	6	65535	Can be configured to 0.3, 1.2, 2.4 (default), 4.8, 9.6, 19.2	512	58
E32 (868T30D)	32	6	65536	Can be configured to 0.3, 1.2, 2.4 (default), 4.8, 9.6, 19.2	512	58
E32 (868T30S)	32	6	65535	Can be configured to 0.3, 1.2, 2.4 (default), 4.8, 9.6, 19.2	512	58
E32 (915T20D)	32	15	65536	Can be configured to 0.3, 1.2, 2.4 (default), 4.8, 9.6, 19.2	512	58
E32 (915T20S)	32	15	65535	Can be configured to 0.3, 1.2, 2.4 (default), 4.8, 9.6, 19.2	512	58
E32 (915T30D)	32	15	65536	Can be configured to 0.3, 1.2, 2.4 (default), 4.8, 9.6, 19.2	512	58
E32 (915T30S)	32	15	65535	Can be configured to 0.3, 1.2, 2.4 (default), 4.8, 9.6, 19.2	512	58
E32 (170T30D)	55	40	65535	Can be configured to 0.3, 0.6, 1.2, 2.4 (default), 4.8, 9.6	512	58
E32 (400T20S)	116	60	65536	Can be configured to 0.3, 1.2, 2.4 (default), 4.8, 9.6, 19.2	512	197

## 2.2. Electrical Parameters

### 2.2.1. Transmitting current

Model	Min	Typ	Max	Unit	Remarks
E32 (433T20DC)	100	110	120	mA	<ul style="list-style-type: none"> <li>When designing current supply circuit, 30% margin is recommended to be remained so as to ensure long-term stable operation of the whole module;</li> <li>The current at the instant of transmitting may be high, but the total energy consumed may be lower due to very short transmitting time;</li> <li>When using external antenna, the impedance matching degree at different frequency points between antenna and module may affect the transmitting current value at different levels.</li> </ul>
E32 (433T20S)	100	110	120	mA	
E32 (433T20S2T)	100	110	120	mA	
E32 (433T27D)	390	410	450	mA	
E32 (433T30D)	570	610	670	mA	
E32 (433T30S)	520	550	610	mA	
E32 (868T20D)	110	120	130	mA	
E32 (868T20S)	105	118	130	mA	
E32 (868T30D)	630	680	750	mA	
E32 (868T30S)	560	600	660	mA	
E32 (915T20D)	110	120	130	mA	
E32 (915T20S)	105	118	130	mA	
E32 (915T30D)	650	700	770	mA	
E32 (915T30S)	560	600	660	mA	
E32 (170T30D)	630	680	750	mA	
E32 (400T20S)	96	106	116	mA	

### 2.2.2. Receiving current

Model	Min	Typ	Max	Unit	Remarks
E32 (433T20DC)	13	14	15	mA	<ul style="list-style-type: none"> <li>The current consumed when the RF chip is only working at receiving mode is called as receiving current, the tested receiving current may be higher for some RF chips with communication protocol or the developers have loaded their own protocol to the whole module.</li> <li>The current at pure receiving mode will be mA level, the users have to realize <math>\mu</math>A level receiving current through firmware development.</li> </ul>
E32 (433T20S)	13	14	15	mA	
E32 (433T20S2T)	13	14	15	mA	
E32 (433T27D)	19	20	22	mA	
E32 (433T30D)	19	20	22	mA	
E32 (433T30S)	22	23	25	mA	
E32 (868T20D)	13	14	15	mA	
E32 (868T20S)	13	14	15	mA	
E32 (868T30D)	24	25	26	mA	
E32 (868T30S)	24	25	26	mA	
E32 (915T20D)	13	14	15	mA	
E32 (915T20S)	13	14	15	mA	
E32 (915T30D)	20	21	22	mA	
E32 (915T30S)	20	21	23	mA	
E32 (170T30D)	21	22	23	mA	
E32 (400T20S)	14	15	16	mA	



## 2.2.3. Turn-off current

Model	Min	Typ	Max	Unit	Remarks
E32 (433T20DC)	3	4	5	μA	<ul style="list-style-type: none"> <li>The turn-off current means the current consumed when CPU, RAM, Clock and some registers remain operating while SoC is at very low power consumption status.</li> <li>The turn-off current is always lower than the current consumed when the power supply source of the whole module is at no-load status.</li> </ul>
E32 (433T20S)	3	4	5	μA	
E32 (433T20S2T)	3	4	5	μA	
E32 (433T27D)	4	5	6	μA	
E32 (433T30D)	4	5	6	μA	
E32 (433T30S)	4	5	6	μA	
E32 (868T20D)	3	4	5	μA	
E32 (868T20S)	3	4	5	μA	
E32 (868T30D)	4	5	6	μA	
E32 (868T30S)	4	5	6	μA	
E32 (915T20D)	3	4	5	μA	
E32 (915T20S)	3	4	5	μA	
E32 (915T30D)	4	5	6	μA	
E32 (915T30S)	4	5	6	μA	
E32 (170T30D)	4	5	6	μA	
E32 (400T20S)	3	4	5	μA	

## 2.2.4. Voltage supply

Model	Min	Typ	Max	Unit	Remarks
E32 (433T20DC)	2.3	3.3	5.2	V DC	<ul style="list-style-type: none"> <li>If the voltage is at maximum value for long time, the module may be damaged;</li> <li>The power supply pin has certain surge-resistance ability, but the potential pulse higher than the maximum power supply voltage;</li> </ul>
E32 (433T20S)	2.3	3.3	5.2	V DC	
E32 (433T20S2T)	2.3	3.3	5.2	V DC	
E32 (433T27D)	3.3	5.0	5.2	V DC	
E32 (433T30D)	3.3	5.0	5.2	V DC	
E32 (433T30S)	3.3	5.0	5.2	V DC	
E32 (868T20D)	2.3	3.3	5.2	V DC	
E32 (868T20S)	2.3	3.3	5.2	V DC	
E32 (868T30D)	3.3	5.0	5.2	V DC	
E32 (868T30S)	3.3	5.0	5.2	V DC	
E32 (915T20D)	2.3	3.3	5.2	V DC	
E32 (915T20S)	2.3	3.3	5.2	V DC	
E32 (915T30D)	3.3	5.0	5.2	V DC	
E32 (915T30S)	3.3	5.0	5.2	V DC	
E32 (170T30D)	3.3	5.0	5.2	V DC	
E32 (400T20S)	2.3	3.3	5.2	V DC	

## 2.2.5. Communication level

Model	Min	Typ	Max	Unit	Remarks
E32 (433T20DC)	2.5	3.3	3.6	V DC	<ul style="list-style-type: none"> <li>● If the communication level is higher than the allowed maximum value, the module may be damaged;</li> <li>● Although the communication level can be switched with various methods, the power consumption of the whole module will be affected at great degree.</li> <li>● Modules are compatible with some of the microcontrollers at 5V communication level. They are too many to be listed here. Please base on practical test or talk to us for more information.</li> </ul>
E32 (433T20S)	2.5	3.3	3.6	V DC	
E32 (433T20S2T)	2.5	3.3	3.6	V DC	
E32 (433T27D)	2.5	3.3	3.6	V DC	
E32 (433T30D)	2.5	3.3	3.6	V DC	
E32 (433T30S)	2.5	3.3	3.6	V DC	
E32 (868T20D)	2.5	3.3	3.6	V DC	
E32 (868T20S)	2.5	3.3	3.6	V DC	
E32 (868T30D)	2.5	3.3	3.6	V DC	
E32 (868T30S)	2.5	3.3	3.6	V DC	
E32 (915T20D)	2.5	3.3	3.6	V DC	
E32 (915T20S)	2.5	3.3	3.6	V DC	
E32 (915T30D)	2.5	3.3	3.6	V DC	
E32 (915T30S)	2.5	3.3	3.6	V DC	
E32 (170T30D)	2.5	3.3	3.6	V DC	
E32 (400T20S)	2.5	3.3	3.6	V DC	

## 2.3. RF Parameters

## 2.3.1. Transmitting power

Model	Min	Typ	Max	Unit	Remarks
E32 (433T20DC)	19.0	20.0	20.4	dBm	<ul style="list-style-type: none"> <li>● Due to the error of the materials, each LRC component has <math>\pm 0.1\%</math> error, so error accumulation will occur since multiple LRC components are used in the whole RF circuit, and the transmitting currents will be different at different modules;</li> <li>● The power consumption can be lowered by lowering the transmitting power, but the efficiency of the internal PA will be decreased by lowering transmitting power due to various reasons;</li> <li>● The transmitting power will be lowered by lowering the power supply voltage.</li> </ul>
E32 (433T20S)	19.0	20.0	20.4	dBm	
E32 (433T20S2T)	19.0	20.0	20.4	dBm	
E32 (433T27D)	26.8	27.0	28.0	dBm	
E32 (433T30D)	29.5	30.0	30.5	dBm	
E32 (433T30S)	29.5	30.0	30.5	dBm	
E32 (868T20D)	19.3	20.0	20.6	dBm	
E32 (868T20S)	19.0	20.0	20.4	dBm	
E32 (868T30D)	29.4	30.0	30.8	dBm	
E32 (868T30S)	29.5	30.0	30.5	dBm	
E32 (915T20D)	19.3	20.0	20.6	dBm	
E32 (915T20S)	19.0	20.0	20.4	dBm	
E32 (915T30D)	29.4	30.0	30.8	dBm	
E32 (915T30S)	29.5	30.0	30.5	dBm	
E32 (170T30D)	29.4	30.0	30.8	dBm	
E32 (400T20S)	19.0	20.0	20.4	dBm	

## 2.3.2. Receiving sensitivity

Model	Typ	Max	Unit	Remarks
E32 (433T20DC)	-144.0	-146.0	-147.0	<ul style="list-style-type: none"> <li>The sensitivity is tested under the air data rate 0.3kbps, coding rate of 4/5 and spreading factor of 12;</li> <li>Due to the error of the materials, each LRC component has <math>\pm 0.1\%</math> error, so error accumulation will occur since multiple LRC components are used in the whole RF circuit, and the transmitting currents will be different at different modules;</li> <li>The receiving sensitivity will be reduced and communication range will be shortened while increasing the air data rate.</li> </ul>
E32 (433T20S)	-144.0	-146.0	-147.0	
E32 (433T20S2T)	-144.0	-146.0	-147.0	
E32 (433T27D)	-145.0	-147.0	-148.0	
E32 (433T30D)	-145.0	-147.0	-148.0	
E32 (433T30S)	-145.0	-147.0	-148.0	
E32 (868T20D)	-144.0	-146.0	-147.0	
E32 (868T20S)	-144.0	-146.0	-147.0	
E32 (868T30D)	-145.0	-147.0	-148.0	
E32 (868T30S)	-145.0	-147.0	-148.0	
E32 (915T20D)	-144.0	-146.0	-147.0	
E32 (915T20S)	-144.0	-146.0	-147.0	
E32 (915T30D)	-145.0	-147.0	-148.0	
E32 (915T30S)	-145.0	-147.0	-148.0	
E32 (170T30D)	-145.0	-147.0	-148.0	
E32 (400T20S)	-144.0	-146.0	-147.0	

## 2.3.3. Recommended working frequency

Model	Min	Typ	Max	Unit	Remarks
E32 (433T20DC)	410	433	441	MHz	<ul style="list-style-type: none"> <li>To work within the recommended frequency can assure the modules to meet all the parameters</li> <li>To avoid the crowded integral frequency like 433.0MHz, 868.0MHz, 915MHz etc. is advisable.</li> </ul>
E32 (433T20S)	410	433	441	MHz	
E32 (433T20S2T)	410	433	441	MHz	
E32 (433T27D)	410	433	441	MHz	
E32 (433T30D)	410	433	441	MHz	
E32 (433T30S)	410	433	441	MHz	
E32 (868T20D)	862	868	893	MHz	
E32 (868T20S)	862	868	893	MHz	
E32 (868T30D)	862	868	893	MHz	
E32 (868T30S)	862	868	893	MHz	
E32 (915T20D)	900	915	931	MHz	
E32 (915T20S)	900	915	931	MHz	
E32 (915T30D)	900	915	931	MHz	
E32 (915T30S)	900	915	931	MHz	
E32 (170T30D)	160	170	173.5	MHz	
E32 (400T20S)	410	470	525	MHz	

## 2.4. Tested range

Model	Min	Typ	Max	Unit	Remarks
E32 (433T20DC)	2700	3000	3300	m	<ul style="list-style-type: none"> <li>● The external antenna used is of 5dBi gain and vertical polarization. The height is 2.5 meters;</li> <li>● The interval between each data packet is 2s, sending 100 packets with 30 bytes in each packet, the range at data lose rate of lower than 5% is valid range;</li> <li>● In order to obtain meaningful and reproducible results, we conducted the tests under in clear weather with little electromagnetic interference at suburb areas;</li> <li>● Distance may be shorter with interference or obstacles.</li> </ul>
E32 (433T20S)	2700	3000	3300	m	
E32 (433T20S2T)	2700	3000	3300	m	
E32 (433T27D)	4500	5000	5500	m	
E32 (433T30D)	7200	8000	8800	m	
E32 (433T30S)	7200	8000	8800	m	
E32 (868T20D)	2700	3000	3300	m	
E32 (868T20S)	1800	2000	2200	m	
E32 (868T30D)	7200	8000	8800	m	
E32 (868T30S)	7200	8000	8800	m	
E32 (915T20D)	2700	3000	3300	m	
E32 (915T20S)	1800	2000	2200	m	
E32 (915T30D)	7200	8000	8800	m	
E32 (915T30S)	7200	8000	8800	m	
E32 (170T30D)	7200	8000	8800	m	
E32 (400T20S)	2700	3000	3300	m	

### 3. Mechanical Characteristics

#### 3.1. E32 (433T20DC)/E32 (915T20D)/E32 (868T20D)

##### 3.1.1. Dimension

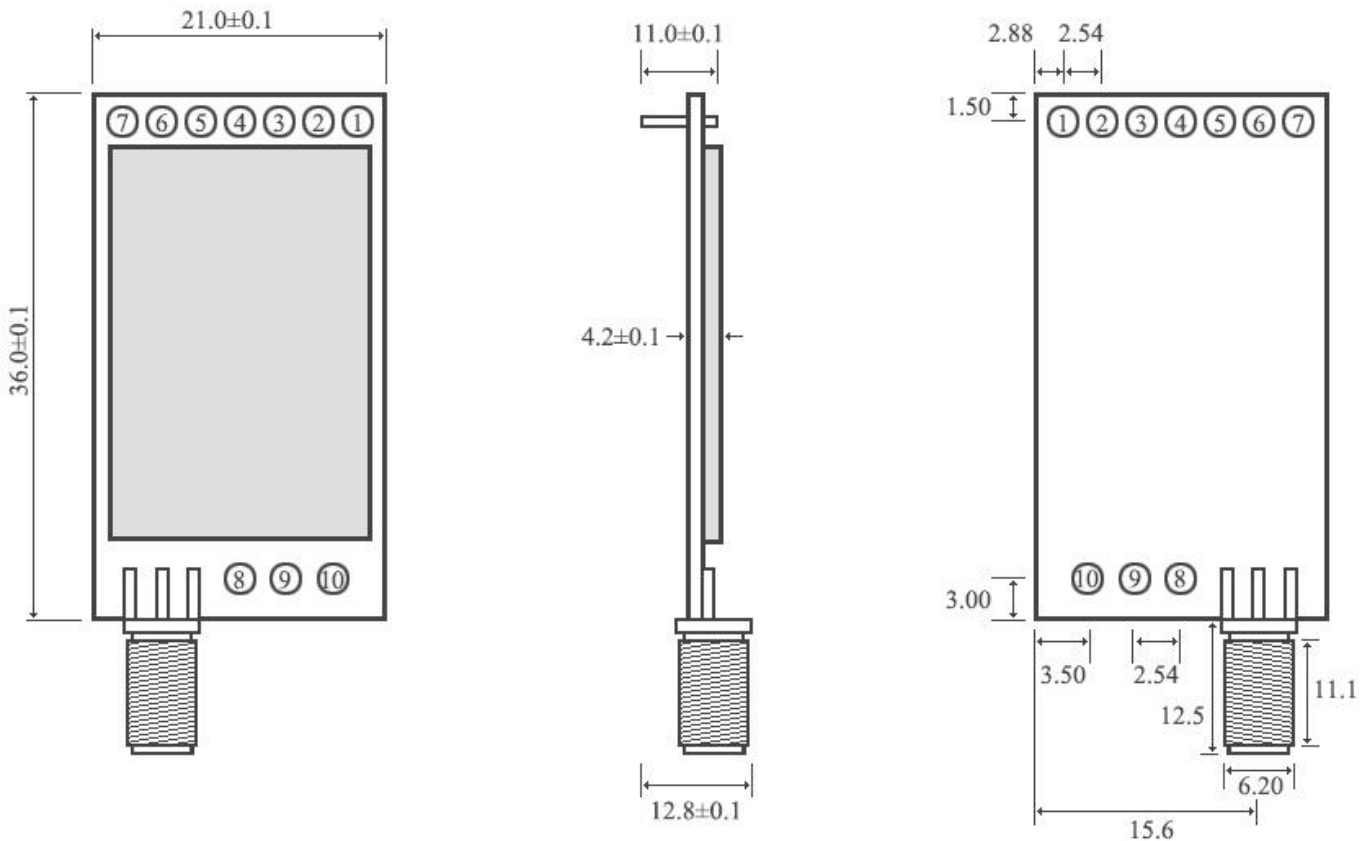

##### 3.1.2. Pin definitions

Pin No.	Pin	Pin direction	Application
1	M0	Input (weak pull-up)	Work with M1 & decide the four operating modes; Floating is not allowed, can be ground.
2	M1	Input (weak pull-up)	Work with M0 & decide the four operating modes; Floating is not allowed, can be ground.
3	RXD	Input	TTL UART inputs, connects to external TXD output pin; Can be configured as open-drain or pull-up input.
4	TXD	Output	TTL UART outputs, connects to external RXD input pin Can be configured as open-drain or push-pull output
5	AUX	Output	To wake up the external MCU, during the procedure of self-check initialization, the pin outputs low level; Can be configured as open-drain output or push-pull output; Floating is allowed.
6	VCC	Input	Voltage positive reference of module; Power supply 2.3V ~ 5.2V DC
7	GND	Input	Ground
8	Fixing hole		Fixing hole
9	Fixing hole		Fixing hole
10	Fixing hole		Fixing hole

### 3.2. E32 (433T20S)

#### 3.2.1. Dimension

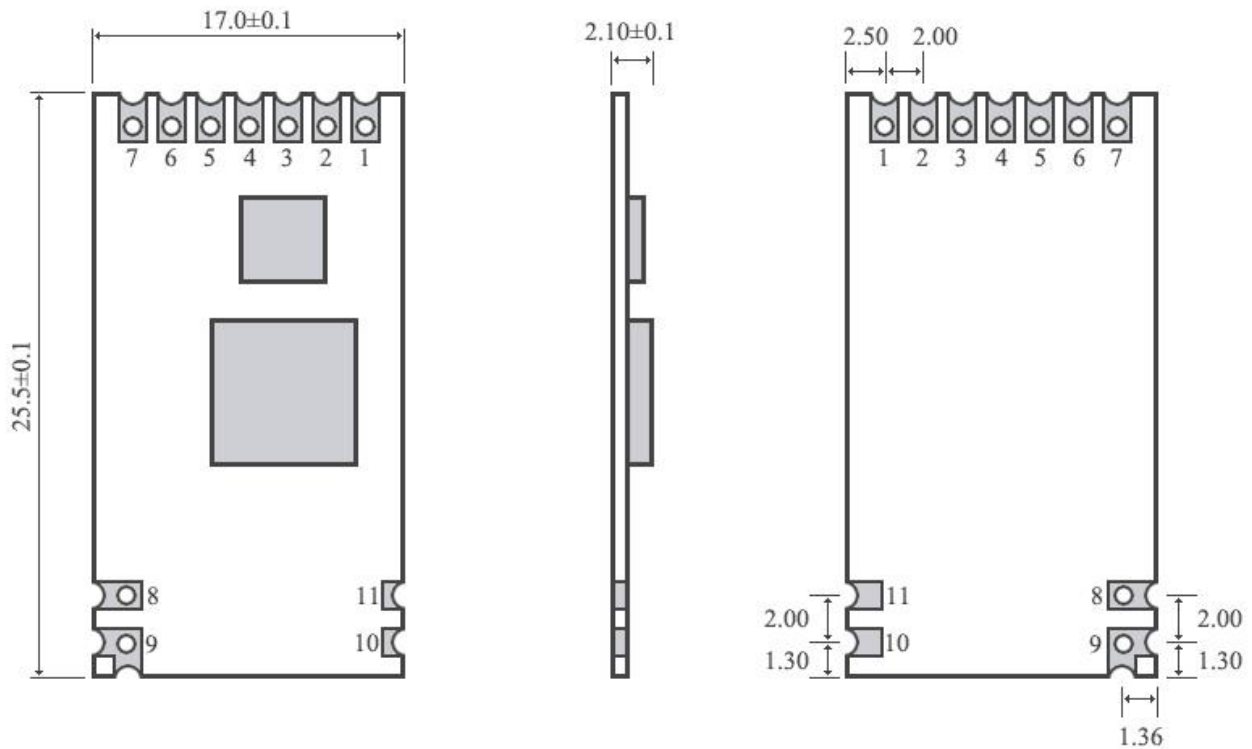

#### 3.2.2. Pin definitions

Pin No.	Pin	Pin direction	Application
1	M0	Input	Work with M1 & decide the four operating modes.
		(weak pull-up)	Floating is not allowed, can be ground.
2	M1	Input	Work with M0 & decide the four operating modes.
		(weak pull-up)	Floating is not allowed, can be ground.
3	RXD	Input	TTL UART inputs, connects to external TXD output pin. Can be configured as open-drain or pull-up input;
4	TXD	Output	TTL UART outputs, connects to external RXD input pin. Can be configured as open-drain or push-pull output
5	AUX	Output	To indicate module working status
			To wake up the external MCU, during the procedure of self-check initialization, pin outputs low level.
			Can be configured as open-drain output or push-pull output
			Floating is allowed
6	VCC	Input	Voltage reference of module
			Power supply 2.3V ~ 5.5V DC
7	GND	Input	Ground
8	GND	Output	Reference places of high frequency signal output
9	ANT	Output	Antenna interface (high frequency signal output)
10	GND	Input	Ground
11	GND	Input	Ground

### 3.3. E32 (433T20S2T)

#### 3.3.1. Dimension

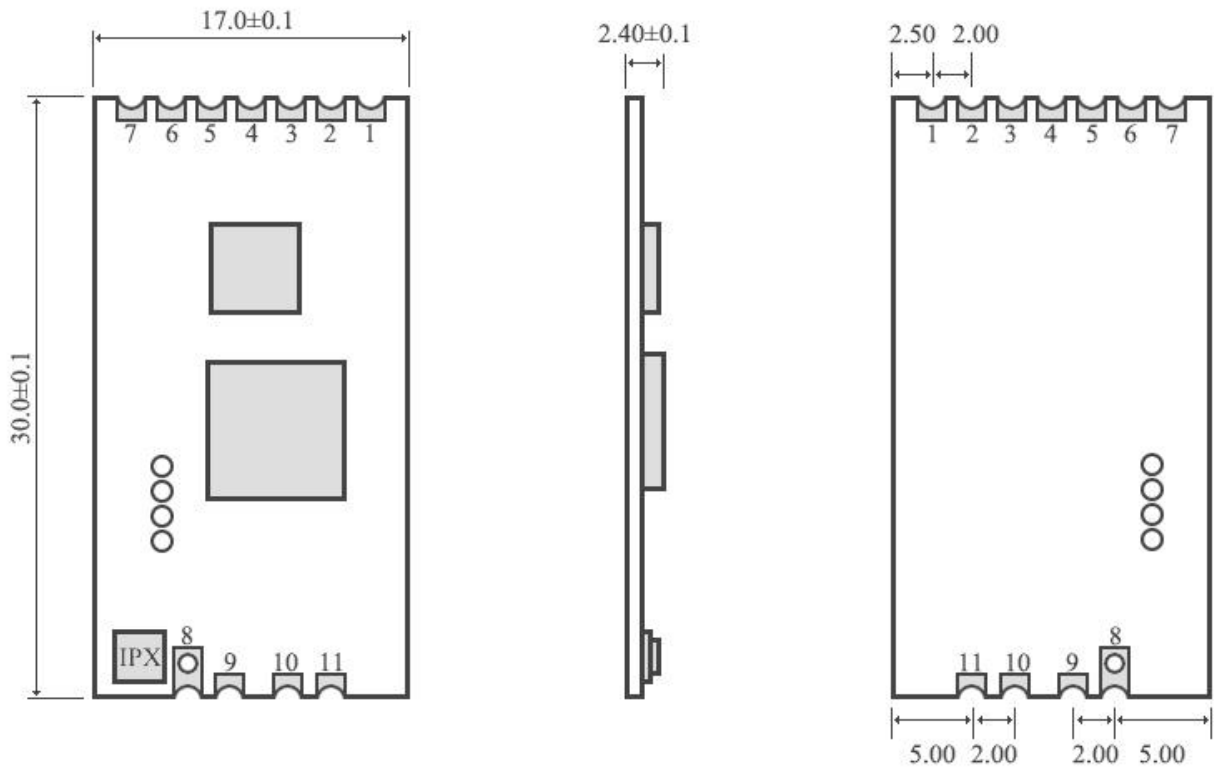

#### 3.3.2. Pin definitions

Pin No.	Pin	Pin direction	Application
1	M0	Input	Work with M1 & decide the four operating modes.
		(weak pull-up)	Floating is not allowed, can be ground.
2	M1	Input	Work with M0 & decide the four operating modes.
		(weak pull-up)	Floating is not allowed, can be ground.
3	RXD	Input	TTL UART inputs, connects to external TXD output pin.
			Can be configured as open-drain or pull-up input;
4	TXD	Output	TTL UART outputs, connects to external RXD input pin.
			Can be configured as open-drain or push-pull output
5	AUX	Output	To indicate module working status
			To wake up the external MCU, during the procedure of self-check initialization, pin outputs low level.
			Can be configured as open-drain output or push-pull output
			Floating is allowed
6	VCC	Input	Voltage reference of module
			Power supply 2.3V ~ 5.2V DC
7	GND	Input	Ground
8	ANT	Output	Antenna interface (high frequency signal output)
9	GND	Output	Reference places of high frequency signal output
10	GND	Input	Ground
11	GND	Input	Ground

### 3.4. E32 (433T27D) / E32-TTL-1W (433T30D) / E32 (915T30D) / E32 (868T30D) / E32 (170T30D)

#### 3.4.1. Dimension

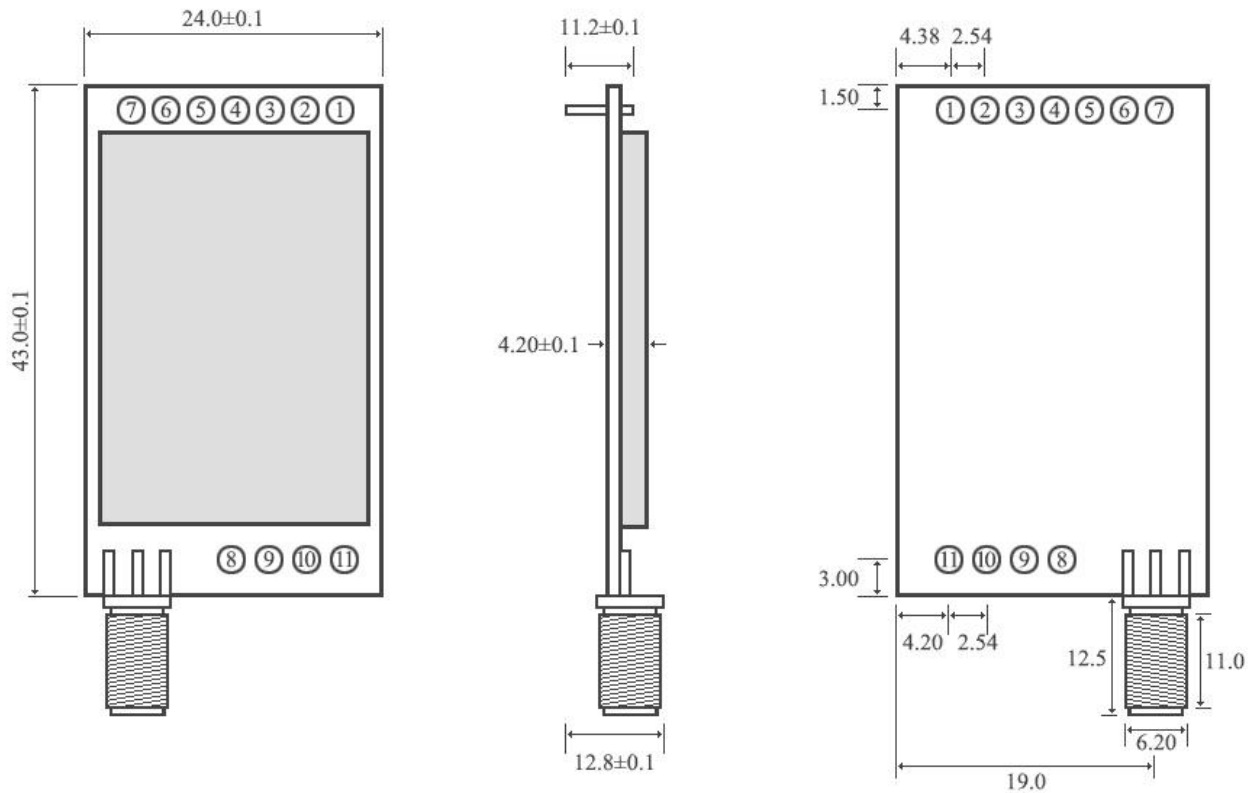

#### 3.4.2. Pin definitions

Pin No.	Pin	Pin direction	Application
1	M0	Input	Work with M1 & decide the four operating modes.
		(weak pull-up)	Floating is not allowed, can be ground.
2	M1	Input	Work with M0 & decide the four operating modes.
		(weak pull-up)	Floating is not allowed, can be ground.
3	RXD	Input	TTL UART inputs, connects to external TXD output pin.
			Can be configured as open-drain or pull-up input;
4	TXD	Output	TTL UART outputs, connects to external RXD input pin.
			Can be configured as open-drain or push-pull output
5	AUX	Output	To indicate module working status
			To wake up the external MCU, during the procedure of self-check initialization, the pin outputs low level.
			Can be configured as open-drain output or push-pull output
			Floating is allowed
6	VCC	Input	Voltage reference of module
			Power supply 3.3V ~ 5.2V DC
7	GND	Input	Ground
8	Fixing hole		Fixing hole
9	Fixing hole		Fixing hole
10	Fixing hole		Fixing hole
11	Fixing hole		Fixing hole



### 3.5. E32 (433T30S)/ E32 (868T30S)/ E32 (915T30S)

#### 3.5.1. Dimension

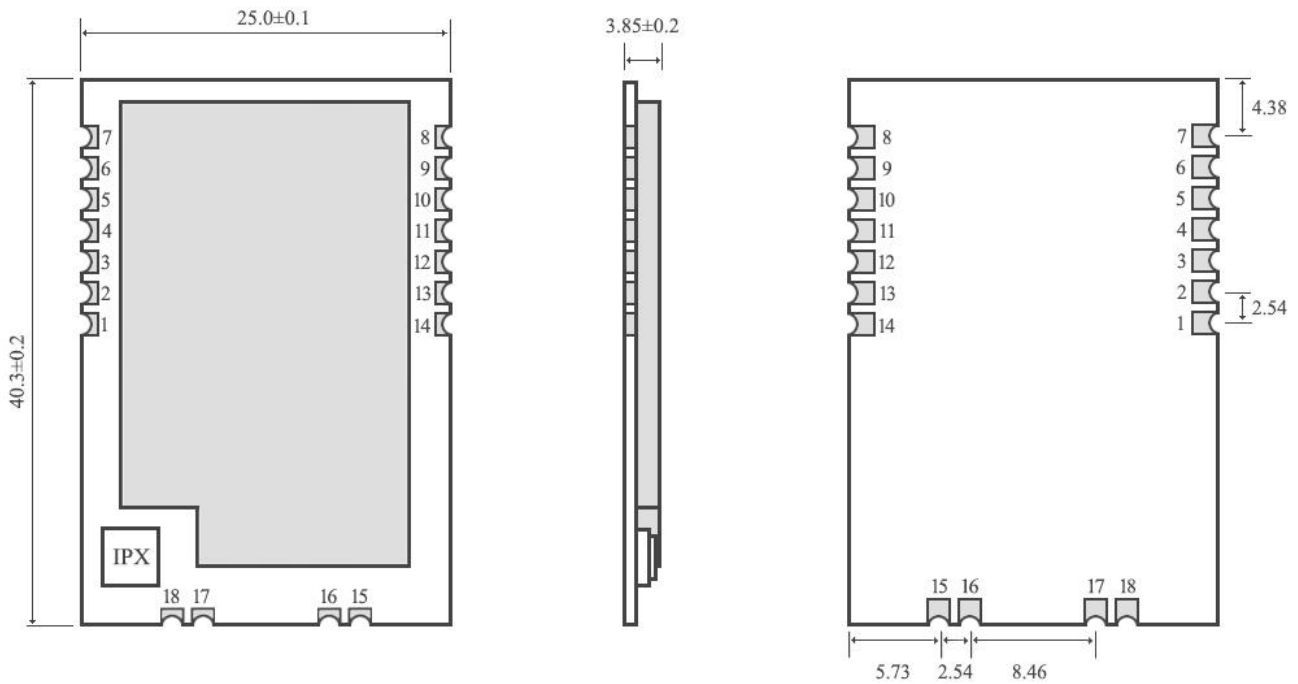

#### 3.5.2. Pin definitions

Pin No.	Pin	Pin direction	Application
1	M0	Input	Work with M1 & decide the four operating modes.
		(weak pull-up)	Floating is not allowed, can be ground.
2	M1	Input	Work with M0 & decide the four operating modes.
		(weak pull-up)	Floating is not allowed, can be ground.
3	RXD	Input	TTL UART inputs, connects to external TXD output pin.
			Can be configured as open-drain or pull-up input.
4	TXD	Output	TTL UART outputs, connects to external RXD input pin.
			Can be configured as open-drain or push-pull output
5	AUX	Input	To indicate module working status & wakes up the external MCU. During the procedure of self-check initialization, the pin outputs low level. Can be configured as open-drain output or push-pull output (floating is allowed).
6	VCC	Input	Voltage reference of module. Power supply 3.3V ~ 5.2V DC
7	GND	Input	Ground
8	RESET	Input	Reset pin when program is loading (floating, users do not need to connect)
9	GND	Input	Ground pin when program is loading (floating, users do not need to connect)
10	SWIM	Input	SWIM pin when program is loading (floating, users do not need to connect)
11	+3.3V	Input	Power supply pin when program is loading (floating, users do not need to connect)
12	PB3	Input / Output	NC pin, need to be floating, not connected (for further development)
13	PB1	Input / Output	NC pin, need to be floating, not connected (for further development)
14	PB0	Input / Output	NC pin, need to be floating, not connected (for further development)
15	GND		Ground
16	GND		Ground
17	GND		Ground
18	ANT	Output	Antenna connector (high level output, 50 characteristic impedance)

### 3.6. E32 (400T20S)/ E32 (868T20S)/ E32 (915T20S)

#### 3.6.1. Dimension

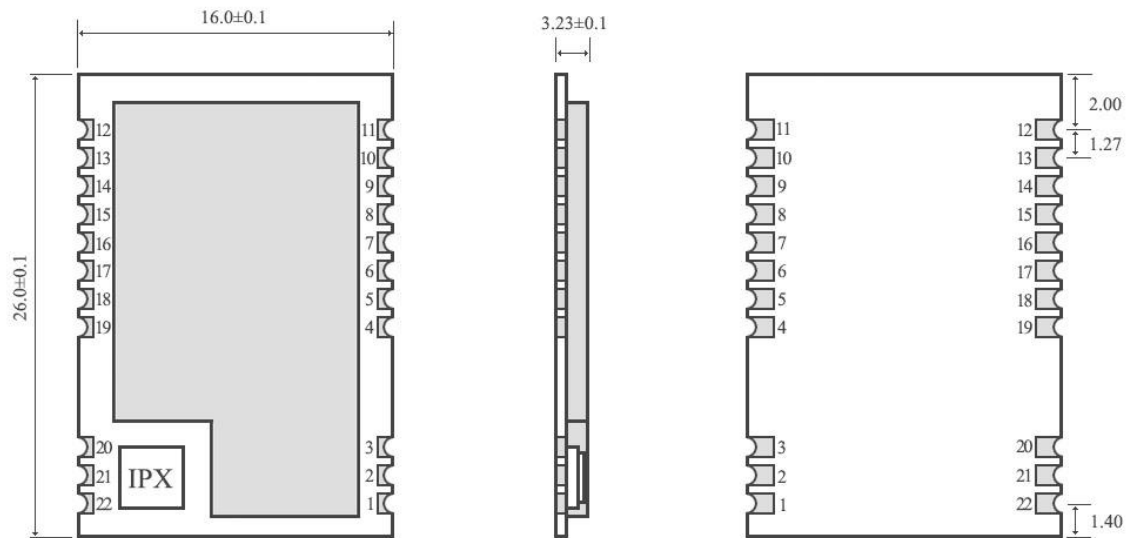

#### 3.6.2. Pin definitions

Pin No.	Pin	Pin direction	Application
1	GND		Ground
2	GND		Ground
3	GND		Ground
4	GND		Ground
5	M0	Input	Work with M1 & decide the four operating modes.
		(weak pull-up)	Floating is not allowed, can be ground.
6	M1	Input	Work with M0 & decide the four operating modes.
		(weak pull-up)	Floating is not allowed, can be ground.
7	RXD	Input	TTL UART inputs, connects to external TXD output pin.
			Can be configured as open-drain or pull-up input.
8	TXD	Output	TTL UART outputs, connects to external RXD input pin.
			Can be configured as open-drain or push-pull output
9	AUX	Output	To indicate module working status & wakes up the external MCU. During the procedure of self-check initialization, the pin outputs low level. Can be configured as open-drain output or push-pull output (floating is allowed).
10	VCC		Voltage reference of module. Power supply 2.3V ~ 5.2V DC
11	GND		Ground
12	NC		
13	GND		Ground
14	NC		
15	NC		
16	NC	Input / Output	
17	NC	Input / Output	
18	NC	Input / Output	
19	GND		Ground
20	GND		Ground
21	ANT	Output	Antenna
22	GND		Ground

## 4. Recommended circuit diagram

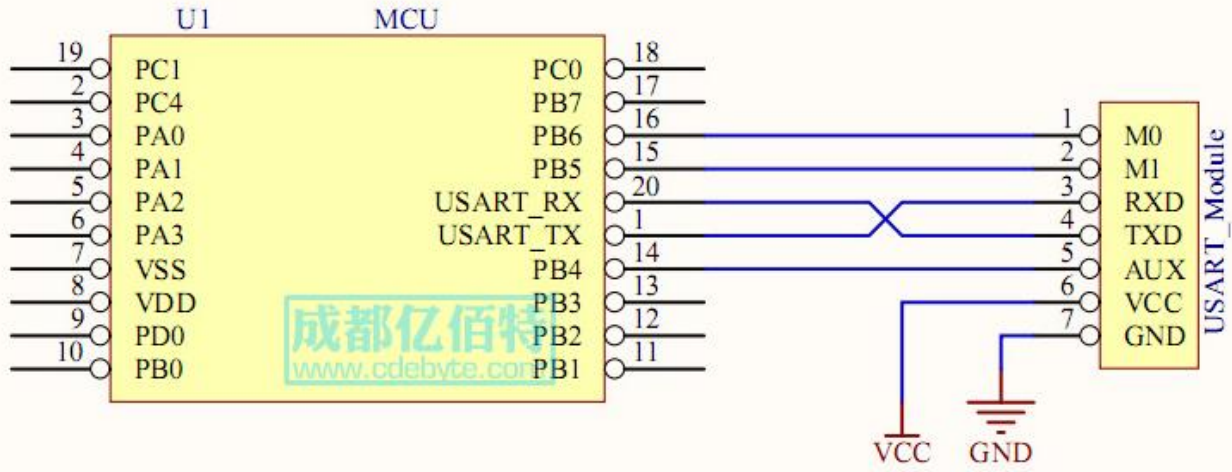

No.	Description (STM8L MCU)
1	The UART module is TTL level. Please connect to MCU of TTL level.
2	For some MCU works at 5VDC, it may need to add 4-10K pull-up resistor for the TXD & AUX pin.

## 5. Function description

### 5.1. Fixed mode

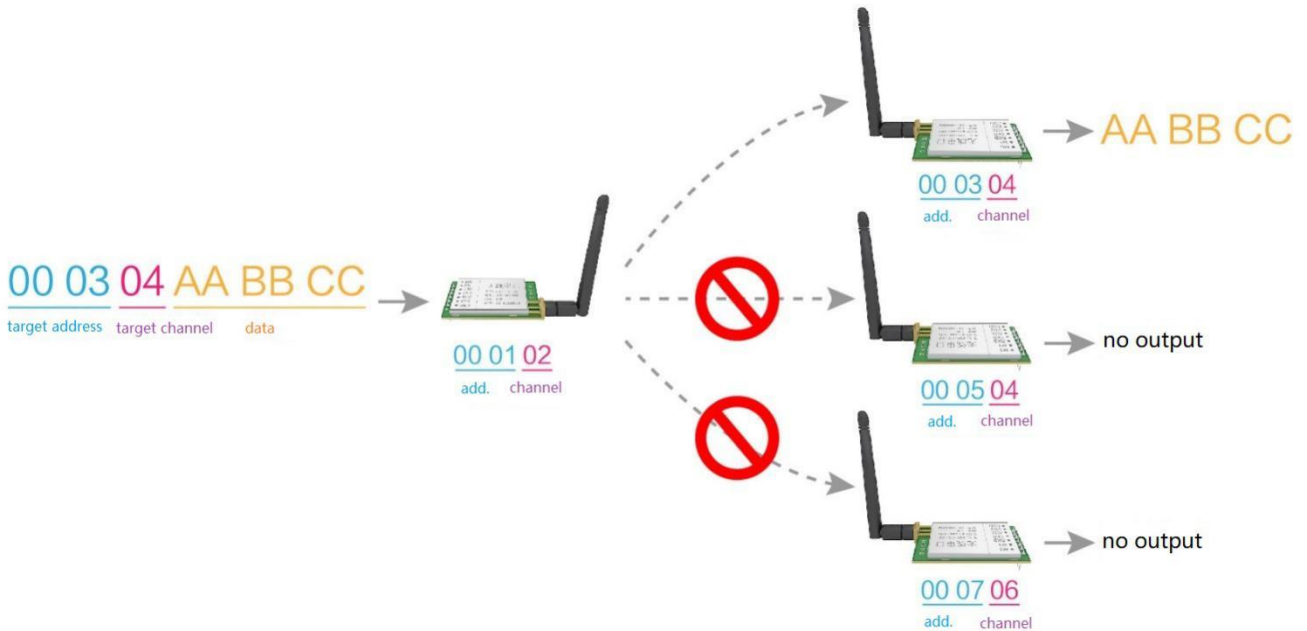

### 5.2. Broadcast mode

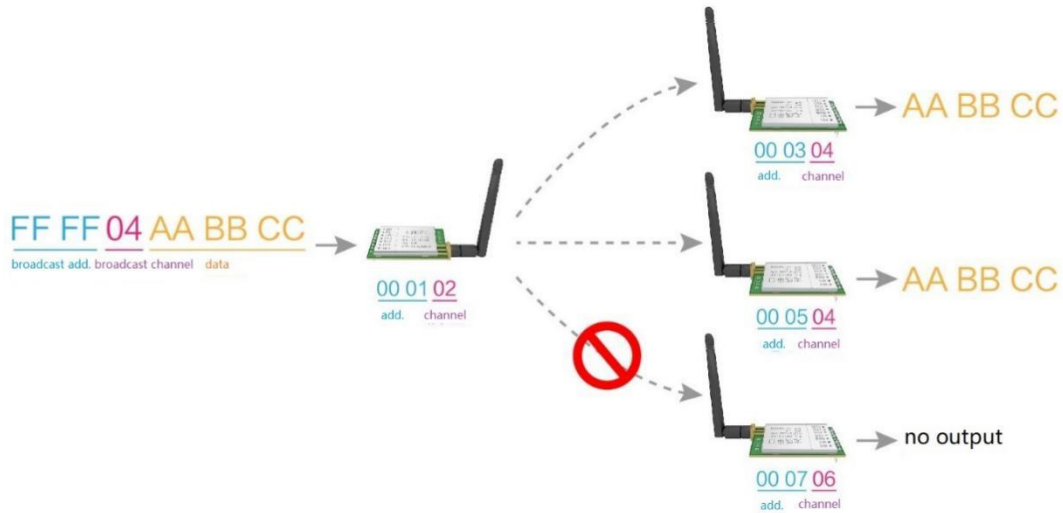

### 5.3. Broadcast address

- i.e.: set the address of module A as 0xFFFF or 0x0000 and channel as 0x04.
- When set A as transmitter (same mode, transparent transmission on), all modules with channel 0x04 will receive data, so as to realize broadcast.

### 5.4. Monitoring address

- i.e.: set the address of module A as 0xFFFF or 0x0000 and channel as 0x04.
- When set A as receiver, it will receive the data transmitted by modules with channel 0x04, so as to realize monitoring,

### 5.5. Module reset

- When the module is powered on, AUX outputs low level immediately, conducts hardware self-check and sets the operating mode on the basis of the user parameters. During the process, the AUX keeps low level. After the process completed, the AUX outputs high level and starts to work as per the operating mode combined by M1 and M0. Therefore, the user needs to wait the AUX rising edge as the starting point of module' s normal work.

### 5.6. AUX description

- AUX Pin can be used as indication for wireless send & receive buffer and self-check. It can indicate whether there are data that are yet to send via wireless way, or whether all wireless data has been sent through UART, or whether the module is still in the process of self-check initialization.

#### 5.6.1. Indication of UART output

- Used to wake up the external MCU

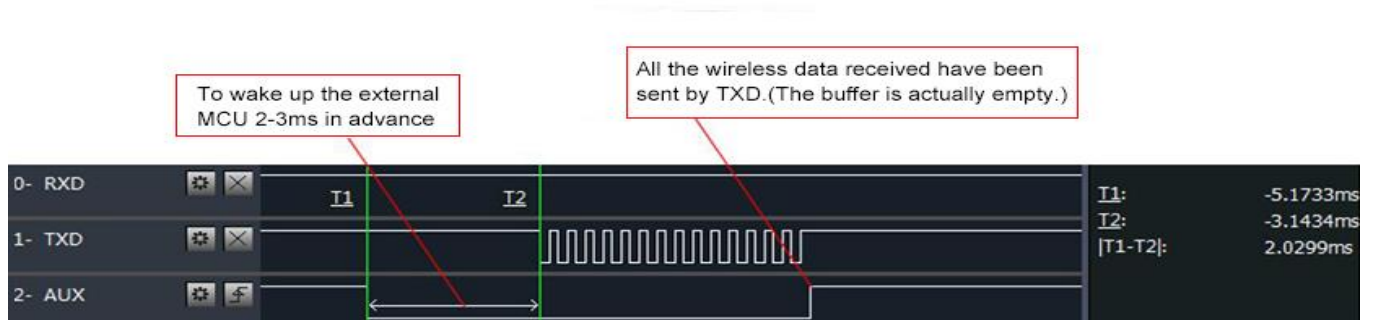

Timing Sequence Diagram of AUX when TXD pin transmits

5.6.2. Indication of wireless transmission

- Buffer (empty): the internal 512 bytes data in the buffer are written to the RFIC (auto sub-packing).
- When AUX=1, the user can input data less than 512 bytes continuously without overflow. when AUX=0, the internal 512 bytes data in the buffer have not been written to the RFIC completely. If the user starts to transmit data at this circumstance, it may cause overtime when the module is waiting for the user data, or transmitting wireless sub package.
- Notes: When AUX = 1, it does not mean that all the UART data of the module have been transmitted already, perhaps the last packet of data is still in transmission

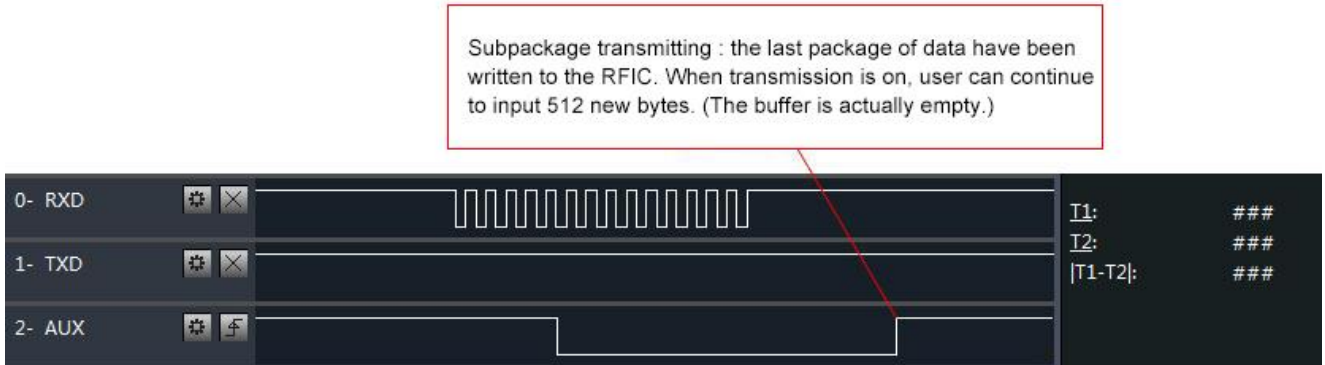

Timing Sequence Diagram of AUX when RXD pin receives

5.6.3. Module in configuration process

Only happened when power-on resetting or exiting sleep mode.

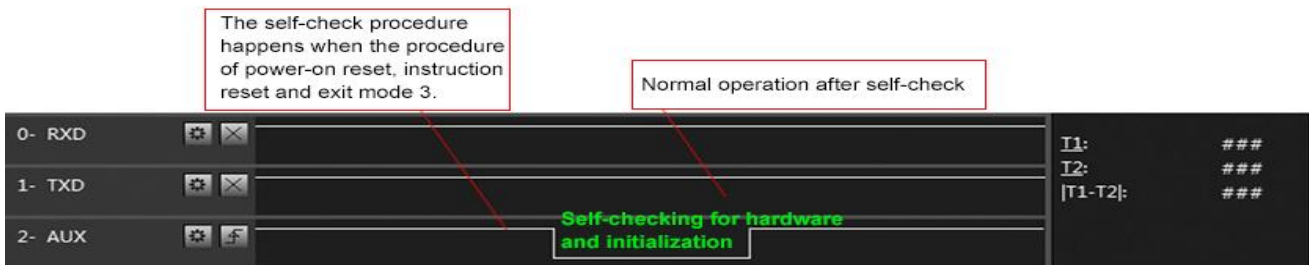

Timing Sequence Diagram of AUX when self-check

5.6.4. Notes for AUX

- For function 1 & function 2 mentioned above, the priority should be given to the one with low level output, which means if it meets each of any low level output condition, AUX outputs low level, if none of the low level condition is met, AUX outputs high level.
- When AUX outputs low level, it means the module is busy & cannot conduct operating mode checking. Within 1ms since AUX outputs high level, the mode switch will be completed.
- After switching to new operating mode, it won't be work in the new mode immediately until AUX rising edge 2ms later. If AUX is on the high level, the operating mode switch can be effected immediately.
- When the user switches to other operating modes from mode 3 (sleep mode) or it's still in reset process, the module will reset user parameters, during which AUX outputs low level.

## 6. Operation Mode

Contents in below table are the introduction of input status of M1 & M0 and their corresponding mode:

Mode (0-3)	M1	M0	Mode introduction	Remark
Mode 0 Normal	0	0	UART and wireless channel are open, transparent transmission is on	The receiver must work in mode 0 or mode 1
Mode 1 Wake-up	1	0	UART and wireless channel are open. The difference between normal mode and wake-up mode is it will add preamble code automatically before data packet transmission so that it can awaken the receiver works in mode 2	The receiver can work in mode 0, mode 1 or mode 2
Mode 2 Power-saving	0	1	UART is disabled. Wireless module works at WOR mode (wake on radio). It will open the UART and transmit data after receiving the wireless data	1, the transmitter must work in mode 1 2, transmitting is not allowed in this mode
Mode 3 Sleep	1	1	Parameter setting	See more in operating parameter

### 6.1. Mode switch

- The user can decide the operating mode by the combination of M1 and M0. The two GPIO of MCU can be used to switch mode. After modifying M1 or M0, it will start to work in new mode 1ms later if the module is free. If there are any serial data that are yet to finish wireless transmitting, it will start to work in new mode after the UART transmitting finished. After the module receives the wireless data & transmits the data through serial port, it will start to work in new mode after the transmitting finished. Therefore, the mode-switch is only valid when AUX outputs 1, otherwise it will delay.
- For example, in mode 0 or mode 1, if the user inputs massive data consecutively and switches operating mode at the same time, the mode-switch operation is invalid. New mode checking can only be started after all the user's data process completed. It is recommended to check AUX pin out status and wait 2ms after AUX outputs high level before switching the mode.
- If the module switches from other modes to stand-by mode, it will work in stand-by mode only after all the remained data process completed. The feature can be used to save power consumption. For example, when the transmitter works in mode 0, after the external MCU transmits data "12345", it can switch to sleep mode immediately without waiting the rising edge of the AUX pin, also the user's main MCU will go dormancy immediately. Then the module will transmit all the data through wireless transmission & go dormancy 1ms later automatically, which reduces MCU working time & save power.
- Likewise, this feature can be used in any mode-switch. The module will start to work in new mode within 1ms after completing present mode task, which enables the user to omit the procedure of AUX inquiry and switch mode swiftly. For example, when switching from transmitting mode to receiving mode, the user MCU can go dormancy before mode-switch, using external interrupt function to get AUX change so that the mode-switch can be realized.
- This operation is very flexible and efficient. It is totally designed on the basis of the user MCU's convenience, at the same time the work load and power consumption of the whole system have been reduced and the efficiency of whole system is largely improved.

## 6.2. Normal mode (mode 0)

<b>When M1 = 0 &amp; M0 = 0, module works in mode 0</b>	
Transmitting	<p>The module can receive the user data via serial port, and transmit wireless data package of 58 bytes. When the data inputted by user is up to 58 byte, the module will start wireless transmission. During which the user can input data continuously for transmission.</p> <p>When the required transmission bytes are less than 58 bytes, the module will wait 3-byte time and treat it as data termination unless continuous data inputted by user. Then the module will transmit all the data through wireless channel.</p> <p>When the module receives the first data packet from user, the AUX outputs low level.</p> <p>After all the data are transmitted into RF chip and transmission start , AUX outputs high level.</p> <p>At this time, it means that the last wireless data package transmission is started, which enables the user to input another 512 bytes continuously. The data package transmitted from the module working in mode 0 can only be received by the module working in mode 0 or 1.</p>
Receiving	<p>The wireless receiving function of the module is on, the data packet transmitted from the module working in mode 0 &amp; mode 1 can be received.</p> <p>After the data packet is received, the AUX outputs low level, 5ms later the module starts to transmit wireless data through serial port TXD pin.</p> <p>After all the wireless data have been transmitted via serial port, the AUX outputs high level.</p>

## 6.3. Wake-up mode (mode 1)

<b>When M1 = 0 &amp; M0 = 1, module works in mode 1</b>	
Transmitting	<p>The condition of data packet transmission &amp; AUX function is the same as mode 0. The only difference is that the module will add preamble code before each data packet automatically. The preamble code length depends on the wake-up time set in the user parameters. The purpose of the preamble code is waking up the receiving module works in mode 2. Therefore, the data package transmitted from mode 1 can be received by mode 0, mode1 and mode 2.</p>
Receiving	<p>The same as that in mode 0.</p>

## 6.4. Power-saving mode (mode 2)

<b>When M1 = 1 &amp; M0 = 0, module works in mode 2</b>	
Transmitting	<p>UART is closed, the module cannot receive any serial port data from outside MCU.</p> <p>Hence the function of wireless transmission is not available for the module working in this mode.</p>
Receiving	<p>In mode 2, it is required the data transmitter works in mode 1.</p> <p>The wireless module monitors the preamble code at regular time.</p> <p>Once it gets the preamble code, it will remain as receiving status and waiting for the completion of receiving the entire valid data package.</p> <p>Then the AUX outputs low level, 5ms later the serial port is open to transmit received wireless data through TXD.</p> <p>Finally, AUX outputs high level after process completed.</p> <p>The wireless module stays in "power-saving – monitoring" working status (polling).</p> <p>By setting different wake-up time, the module will have different receiving response delay (2s in maximum) and average power consumption (30uA in minimum).</p> <p>The user needs to achieve a balance between communication delay time &amp; average power consumption.</p>

## 6.5. Sleep mode (mode 3)

When M1=1, M0=1, module works in mode 3	
Transmitting	N/A
Receiving	N/A
Parameter setting	This mode can be used for parameter setting. It uses serial port 9600 & 8N1 to set module working parameters through specific instruction format. (pls refer to parameters setting for details)
Notes	When the mode changes from stand-by mode to others, the module will reset its parameters, during which the AUX keeps low level and then outputs high level after reset completed. It is recommended to check the AUX rising edge for user.

## 7. Command format

In sleep mode (Mode 3: M1=1, M0=1) , it supports below instructions on list.

(Only support 9600 and 8N1 format when setting)

No.	Instruction format	Illustration
1	C0 + working parameters	C0 + 5 bytes working parameters are sent in hexadecimal format. 6 bytes in total and must be sent in succession. ( Save the parameters when power-down )
2	C1+C1+C1	Three C1 are sent in hexadecimal format. The module returns the saved parameters and must be sent in succession.
3	C2 + working parameters	C2 + 5 bytes working parameters are sent in hexadecimal format. 6 bytes in total and must be sent in succession. ( Do not save the parameters when power-down )
4	C3+C3+C3	Three C3 are sent in hexadecimal format. The module returns the version information and they must be sent in succession.
5	C4+C4+C4	Three C4 are sent in hexadecimal format. The module will reset one time and they must be sent in succession.

### 7.1. Default parameters

#### 7.1.1. Operating frequency 433MHz:

Default parameter values: C0 00 00 1A 17 44							
Model	Frequency	Address	Channel	Air data rate	Baud rate	Parity	Transmitting power
E32-TTL-100 (433T20DC)	433MHz	0x0000	0x17	2.4kbps	9600	8N1	100mW

Default parameter values: C0 00 00 1A 17 44							
Model	Frequency	Address	Channel	Air data rate	Baud rate	Parity	Transmitting power
E32 (433T20S)	433MHz	0x0000	0x17	2.4kbps	9600	8N1	100mW

Default parameter values: C0 00 00 1A 17 44								
型号	Model	Frequency	Address	Channel	Air data rate	Baud rate	Parity	Transmitting power
	E32 (433T120S2)	433MHz	0x0000	0x17	2.4kbps	9600	8N1	100mW



Default parameter values: C0 00 00 1A 17 44							
Model	Frequency	Address	Channel	Air data rate	Baud rate	Parity	Transmitting power
E32 (433T27D)	433MHz	0x0000	0x17	2.4kbps	9600	8N1	500mW

Default parameter values: C0 00 00 1A 17 44							
Model	Frequency	Address	Channel	Air data rate	Baud rate	Parity	Transmitting power
E32 (433T30D)	433MHz	0x0000	0x17	2.4kbps	9600	8N1	1W

## 7.1.2. Operating frequency 470MHz:

Default parameter values: C0 00 00 1A aC 44							
Model	Frequency	Address	Channel	Air data rate	Baud rate	Parity	Transmitting power
E32 (400T20S)	470MHz	0x0000	0xaC	2.4kbps	9600	8N1	20dBm

## 7.1.3. Operating frequency 868MHz:

Default parameter values: C0 00 00 1A 06 40							
Model	Frequency	Address	Channel	Air data rate	Baud rate	Parity	Transmitting power
E32 (868T20S)	868MHz	0x0000	0x06	2.4kbps	9600	8N1	100mW

Default parameter values: C0 00 00 1A 06 44							
Model	Frequency	Address	Channel	Air data rate	Baud rate	Parity	Transmitting power
E32 (868T20D)	868MHz	0x0000	0x06	2.4kbps	9600	8N1	100mW

Default parameter values: C0 00 00 1A 06 44							
Model	Frequency	Address	Channel	Air data rate	Baud rate	Parity	Transmitting power
E32 (868T30D)	868MHz	0x0000	0x06	2.4kbps	9600	8N1	1W

Default parameter values: C0 00 00 1A 06 44							
Model	Frequency	Address	Channel	Air data rate	Baud rate	Parity	Transmitting power
E32 (868T30S)	868MHz	0x0000	0x06	2.4kbps	9600	8N1	1W

## 7.1.4. Operating frequency 915MHz:

Default parameter values: C0 00 00 1A 0F 44							
Model	Frequency	Address	Channel	Air data rate	Baud rate	Parity	Transmitting power
E32 (915T20S)	915MHz	0x0000	0x0F	2.4kbps	9600	8N1	100mW

Default parameter values: C0 00 00 1A 0F 44							
Model	Frequency	Address	Channel	Air data rate	Baud rate	Parity	Transmitting power
E32 (915T20D)	915MHz	0x0000	0x0F	2.4kbps	9600	8N1	100mW

Default parameter values: C0 00 00 1A 0F 44							
Model	Frequency	Address	Channel	Air data rate	Baud rate	Parity	Transmitting power
E32 (915T30D)	915MHz	0x0000	0x0F	2.4kbps	9600	8N1	1W

Default parameter values: C0 00 00 1A 0F 44							
Model	Frequency	Address	Channel	Air data rate	Baud rate	Parity	Transmitting power
E32 (915T30S)	915MHz	0x0000	0x0F	2.4kbps	9600	8N1	1W

### 7.1.5. Operating frequency 915MHz:

Default parameter values: C0 01 0A 1A 0A 44							
Model	Frequency	Address	Channel	Air data rate	Baud rate	Parity	Transmitting power
E32 (170T30D)	170MHz	0x0000	0x28	2.4kbps	9600	8N1	1W

## 7.2. Reading operating parameters

Instruction format	Description
C1+C1+C1	In sleep mode (M0=1, M1=1), User gives the module instruction (HEX format): C1 C1 C1, Module returns the present configuration parameters. For example, C2 00 00 1A 17 44.

## 7.3. Reading version number

Instruction format	Description
C3+C3+C3	In sleep mode (M0=1, M1=1) , User gives the module instruction (HEX format): C3 C3 C3, Module returns its present version number, for example C3 32 xx yy. 32 here means the module model (E32 series); xx is the version number and yy refers to the other module features.

## 7.4. Reset command

Instruction format	Description
C4+C4+C4	In sleep mode (M0=1, M1=1) , User gives the module instruction (HEX format): C4 C4 C4, the module resets for one time. During the reset process, the module will conduct self-check, AUX outputs low level. After reset completing, the AUX outputs high level, then the module starts to work regularly which the working mode can be switched or be given another instruction.

7.5. Parameter setting command

No.	Item	Description				Remark	
0	HEAD	Fix 0xC0 or 0xC2, it means this frame data is control command				<ul style="list-style-type: none"> <li>Must be 0xC0 or 0xC2</li> <li>C0: Save the parameters when power-down</li> <li>C2: Do not save the parameters when power-down</li> </ul>	
1	ADDH	High address byte of module (the default 00H)				00H-FFH	
2	ADDL	Low address byte of module (the default 00H)				00H-FFH	
3	SPED	7	6	UART parity bit		<ul style="list-style-type: none"> <li>UART mode can be different between communication parties</li> </ul>	
		0	0	8N1 (default)			
		0	1	8O1			
		1	0	8 E1			
		1	1	8N1 (equal to 00)			
		5	4	3	TTL UART baud rate (bps)		<ul style="list-style-type: none"> <li>UART baud rate can be different between communication parties</li> <li>The UART baud rate has nothing to do with wireless transmission parameters &amp; won't affect the wireless transmit / receive features.</li> </ul>
		0	0	0	1200		
		0	0	1	2400		
		0	1	0	4800		
		0	1	1	9600 (default)		
		1	0	0	19200		
		1	0	1	38400		
		1	1	0	57600		
		1	1	1	115200		
		2	1	0	Air data rate (bps)		
		0	0	0	0.3k		
		0	0	1	1.2k		
		0	1	0	2.4k (default)		
		0	1	1	4.8k		
1	0	0	9.6k				
1	0	1	19.2k				
1	1	0	19.2k (same to 101)				
1	1	1	19.2k (same to 101)				
4	CHAN	7	6	5	reserved	Write 0	
		Communication channel				00H-1FH, correspond to 410~441MHz	
		4-0: Communication channel (410M + CHAN*1M) , default 17H (433MHz)					

5	OPTION	7	Fixed transmission enabling bit (similar to MODBUS)			<ul style="list-style-type: none"> <li>In fixed transmission mode, the first three bytes of each user's data frame can be used as high/low address and channel. The module changes its address and channel when transmit. And it will revert to original setting after complete the process.</li> </ul>		
		0	Transparent transmission mode					
		1	Fixed transmission mode					
		6	IO drive mode ( default 1)				<ul style="list-style-type: none"> <li>This bit is used to the module internal pull-up resistor. It also increases the level' s adaptability in case of open drain. But in some cases, it may need external pull-up resistor.</li> </ul>	
		1	TXD and AUX push-pull outputs, RXD pull-up inputs					
		0	TXD、 AUX open-collector outputs, RXD open-collector inputs					
		5	4	3	wireless wake-up time		<ul style="list-style-type: none"> <li>The transmit &amp; receive module work in mode 0, whose delay time is invalid &amp; can be arbitrary value.</li> <li>The transmitter works in mode 1 can transmit the preamble code of the corresponding time continuously.</li> <li>When the receiver works in mode 2, the time means the monitor interval time (wireless wake-up). Only the data from transmitter that works in mode 1 can be received.</li> </ul>	
		0	0	0	250ms (default)			
		0	0	1	500ms			
		0	1	0	750ms			
		0	1	1	1000ms			
		1	0	0	1250ms			
		1	0	1	1500ms			
		1	1	0	1750ms			
		1	1	1	2000ms			
		2	FEC switch					<ul style="list-style-type: none"> <li>After turn off FEC, the actual data transmission rate increases while anti-interference ability decreases. Also the transmission distance is relatively short.</li> <li>Both communication parties must keep on the same pages about turn-on or turn-off FEC.</li> </ul>
		0	Turn off FEC					
		1	Turn on FEC (default)					
		1	0	Transmission power (approximation)			<p>Applicable for E32-TTL-100, E32-TTL-100S1, E32-T100S2.</p> <p>The external power must make sure the ability of current output more than 250mA and ensure the power supply ripple within 100mV.</p> <p>Low power transmission is not recommended due to its low power supply efficiency.</p>	
		0	0	20dBm (default)				
		0	1	17dBm				
		1	0	14dBm				
		1	1	10dBm				
		1	0	Transmission power (approximation)				
		0	0	27dBm (default)				
		0	1	24dBm				
		1	0	21dBm			<p>Applicable for E32-TTL-500.</p> <p>The external power must make sure the ability of current output more than 700mA and ensure the power supply ripple within 100mV.</p> <p>Low power transmission is not recommended due to its low power supply efficiency.</p>	
		1	1	18dBm				

	1	0	Transmission power (approximation)		Applicable for E32-TTL-1W, E32 (433T30S), E32 (868T30S), E32 (915T30S)  The external power must make sure the ability of current output more than 1A and ensure the power supply ripple within 100mV.  Low power transmission is not recommended due to its low power supply efficiency.
	0	0	30dBm (default)		
	0	1	27dBm		
	1	0	24dBm		
	1	1	21dBm		

**For example: The meaning of No.3 "SPED" byte:**

The binary bit of the byte	7	6	5	4	3	2	1	0
Configures by user	0	0	0	1	1	0	1	0
Meaning	UART parity bit 8N1		UART baud rate is 9600			Air data rate is 2.4k		
Corresponding hexadecimal	1				A			

## 8. Parameter setting

When the module is under mode 2 (M1M0=11), module parameters could be configured by command or host computer software.

Please visit [www.cdebyte.com](http://www.cdebyte.com) to download parameter configuring software.



## 9. Production guidance

### 9.1. Reflow soldering temperature

Profile Feature	Curve characteristics	Sn-Pb Assembly	Pb-Free Assembly
Solder Paste	Solder paste	Sn63/Pb37	Sn96.5/Ag3/Cu0.5
Preheat Temperature min (T <sub>smin</sub> )	Min preheating temp.	100°C	150°C
Preheat temperature max (T <sub>smax</sub> )	Mx preheating temp.	150°C	200°C
Preheat Time (T <sub>smin</sub> to T <sub>smax</sub> )(t <sub>s</sub> )	Preheating time	60-120 sec	60-120 sec
Average ramp-up rate(T <sub>smax</sub> to T <sub>p</sub> )	Average ramp-up rate	3°C/second max	3°C/second max
Liquidous Temperature (T <sub>L</sub> )	Liquid phase temp.	183°C	217°C
Time (t <sub>L</sub> ) Maintained Above (T <sub>L</sub> )	Time below liquid phase line	60-90 sec	30-90 sec
Peak temperature (T <sub>p</sub> )	Peak temp.	220-235°C	230-250°C
Average ramp-down rate (T <sub>p</sub> to T <sub>smax</sub> )	Average ramp-down rate	6°C/second max	6°C/second max
Time 25°C to peak temperature	Time to peak temperature for 25°C	max 6 minutes	max 8 minutes

### 9.2. Reflow soldering curve

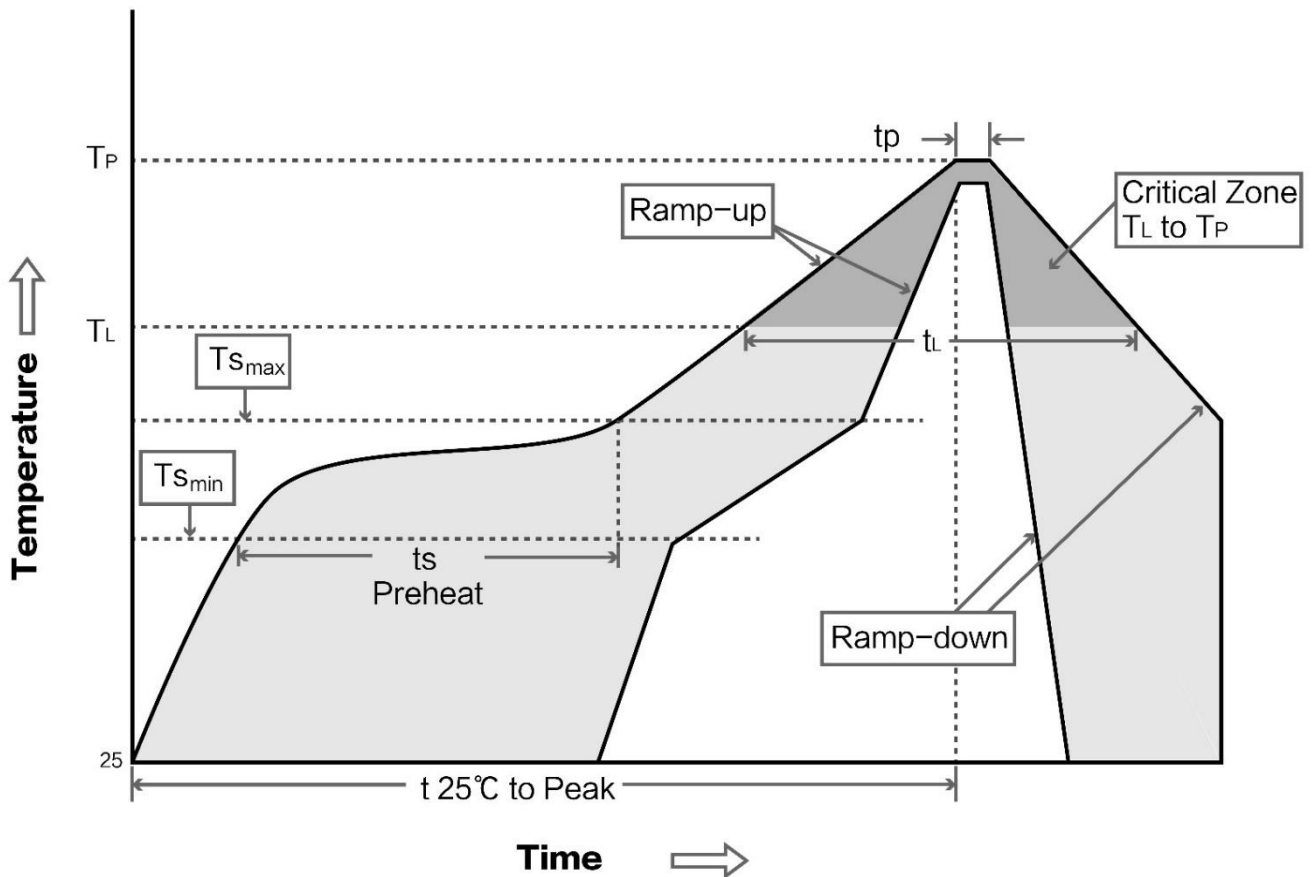

## 10. FAQ

### 10.1. Communication range is too short

- The communication distance will be affected when obstacle exists.
- Data lose rate will be affected by temperature, humidity and co-channel interference.
- The ground will absorb and reflect wireless radio wave, so the performance will be poor when testing near ground.
- Sea water has great ability in absorbing wireless radio wave, so performance will be poor when testing near the sea.
- The signal will be affected when the antenna is near metal object or put in a metal case.
- Power register was set incorrectly, air data rate is set as too high (the higher the air data rate, the shorter the distance).
- The power supply low voltage under room temperature is lower than 2.5V, the lower the voltage, the lower the transmitting power.
- Due to antenna quality or poor matching between antenna and module.

### 10.2. Module is easy to damage

- Please check the power supply source, ensure it is 2.0V~3.6V, voltage higher than 3.6V will damage the module.
- Please check the stability of power source, the voltage cannot fluctuate too much.
- Please make sure anti-static measure are taken when installing and using, high frequency devices have electrostatic susceptibility.
- Please ensure the humidity is within limited range, some parts are sensitive to humidity.
- Please avoid using modules under too high or too low temperature.

## 11. Important declarations

- All rights to interpret and modify this manual belong to Ebyte.
- This manual will be updated based on the upgrade of firmware and hardware, please refer to the latest version.
- Please refer to our website for new product information.

## 12. About us

Technical support: [support@cdebyte.com](mailto:support@cdebyte.com)

Documents and RF Setting Software downloading: [www.cdebyte.com](http://www.cdebyte.com)

---

Tel: +86-28-61399028 (ext. 812)

Fax: +86-28-64146160

Web: [www.cdebyte.com](http://www.cdebyte.com)

Address: Innovation Center D347, 4# XI-XIN Road, Chengdu, Sichuan, China

