

TS79M00 Series

3-Terminal 500mA Negative Voltage Regulator

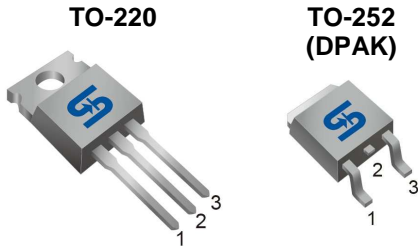

Pin Definition:
 1. Ground
 2. Input (tab)
 3. Output

General Description

The TS79M00 series of fixed output negative voltage regulators are intended as complements to the popular TS78M00 series device. These negative regulators are available in the same seven-voltage options as the TS7900 devices. In addition, one extra voltage option commonly employed in MECL systems is also available in the negative TS79M00 Series. Available in fixed output voltage options from -5.0 to -24 volts, these regulators employ current limiting, thermal shutdown, and safe-area compensation--making them remarkably rugged under most operating conditions. With adequate heat sinking they can deliver output currents in excess of 0.5 ampere.

Features

- Output Voltage: -5 & -12V
- Output current up to 0.5A
- No external components required
- Internal thermal overload protection
- Internal short-circuit current limiting
- Output transistor safe-area compensation
- Output voltage offered in 4% tolerance

Standard Application Circuit

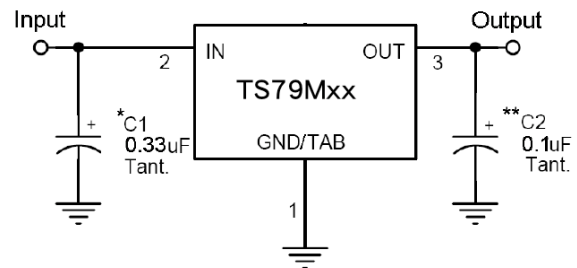

A common ground is required between the input and the output voltages. The input voltage must remain typically 2.0V above the output voltage even during the low point on the Input ripple voltage.

XX = these two digits of the type number indicate voltage.

* = Cin is required if regulator is located an appreciable distance from power supply filter.

** = Co is not needed for stability; however, it does improve transient response.

Ordering Information

Part No.	Package	Packing
TS79MxxCZ C0	TO-220	50pcs / Tube
TS79MxxCP RO	TO-252	2.5Kpcs / 13" Reel

Note: Refer to detail ordering information table.

Absolute Maximum Ratings (T_A = 25°C unless otherwise noted)

Parameter	Symbol	Limit	Unit
Input Voltage	V _{IN}	-35	V
Power Dissipation	P _D	Internal Limited	W
Operating Junction Temperature	T _J	0~+125	°C
Storage Temperature Range	T _{STG}	-65~+150	°C
Thermal Resistance - Junction to Case	TO-220	5	°C/W
	TO-252	6	
Thermal Resistance - Junction to Ambient	TO-220	65	°C/W
	TO-252	92	

Note: Follow the derating curve

TS79M00 Series

3-Terminal 500mA Negative Voltage Regulator

TS79M05 Electrical Characteristics

($V_{IN}=-10V$, $I_{OUT}=350mA$, $0^{\circ}C \leq T_J \leq 125^{\circ}C$, $C_{IN}=0.33\mu F$, $C_{OUT}=0.1\mu F$; unless otherwise specified.)

Parameter	Symbol	Test Condition	Min	Typ	Max	Unit	
Output voltage	V_{OUT}	$T_J=25^{\circ}C$	-4.80	-5	-5.20	V	
		$-7.5V \leq V_{IN} \leq -20V$, $5mA \leq I_{OUT} \leq 500mA$, $P_D \leq 5W$	-4.75	-5	-5.25		
Line Regulation	REG_{LINE}	$T_J=25^{\circ}C$	$-7.5V \leq V_{IN} \leq -25V$	--	7	50	mV
			$-8V \leq V_{IN} \leq -18V$	--	2	30	
Load Regulation	REG_{LOAD}	$T_J=25^{\circ}C$	$5mA \leq I_{OUT} \leq 500mA$	--	20	100	
			$250mA \leq I_{OUT} \leq 200mA$	--	10	50	
Quiescent Current	I_Q	$I_{OUT}=0$, $T_J=25^{\circ}C$	--	4	8	mA	
Quiescent Current Change	ΔI_Q	$-7.5V \leq V_{IN} \leq -25V$	--	--	1		
		$5mA \leq I_{OUT} \leq 500mA$	--	--	0.5		
Output Noise Voltage	V_N	$10Hz \leq f \leq 100KHz$, $T_J=25^{\circ}C$	--	40	--	μV	
Ripple Rejection Ratio	RR	$f=120Hz$, $-8V \leq V_{IN} \leq -18V$	54	66	--	dB	
Voltage Drop	V_{DROP}	$I_{OUT}=500mA$, $T_J=25^{\circ}C$	--	2	--	V	
Peak Output Current	$I_{O\ peak}$	$T_J=25^{\circ}C$	--	2.1	--	A	
Temperature Coefficient of Output Voltage	$\Delta V_{OUT} / \Delta T_J$	$I_{OUT}=5mA$, $0^{\circ}C \leq T_J \leq 125^{\circ}C$	--	-0.1	--	$mV/^{\circ}C$	

TS79M12 Electrical Characteristics

($V_{IN}=-19V$, $I_{OUT}=350mA$, $0^{\circ}C \leq T_J \leq 125^{\circ}C$, $C_{IN}=0.33\mu F$, $C_{OUT}=0.1\mu F$; unless otherwise specified.)

Parameter	Symbol	Test Condition	Min	Typ	Max	Unit	
Output voltage	V_{OUT}	$T_J=25^{\circ}C$	-11.53	-12	-12.48	V	
		$-14.5V \leq V_{IN} \leq -27V$, $5mA \leq I_{OUT} \leq 500mA$, $P_D \leq 5W$	-11.42	-12	-12.60		
Line Regulation	REG_{LINE}	$T_J=25^{\circ}C$	$-14.5V \leq V_{IN} \leq -30V$	--	10	240	mV
			$-15V \leq V_{IN} \leq -19V$	--	3	120	
Load Regulation	REG_{LOAD}	$T_J=25^{\circ}C$	$5mA \leq I_{OUT} \leq 500mA$	--	12	240	
			$250mA \leq I_{OUT} \leq 200mA$	--	4	120	
Quiescent Current	I_Q	$T_J=25^{\circ}C$, $I_{OUT}=0$	--	4.3	8	mA	
Quiescent Current Change	ΔI_Q	$-14.5V \leq V_{IN} \leq -30V$	--	--	1		
		$5mA \leq I_{OUT} \leq 500mA$	--	--	0.5		
Output Noise Voltage	V_N	$10Hz \leq f \leq 100KHz$, $T_J=25^{\circ}C$	--	75	--	μV	
Ripple Rejection Ratio	RR	$f=120Hz$, $-15V \leq V_{IN} \leq -25V$	55	70	--	dB	
Voltage Drop	V_{DROP}	$I_{OUT}=500mA$, $T_J=25^{\circ}C$	--	2	--	V	
Peak Output Current	$I_{O\ peak}$	$T_J=25^{\circ}C$	--	2.1	--	A	
Temperature Coefficient of Output Voltage	$\Delta V_{OUT} / \Delta T_J$	$I_{OUT}=5mA$, $0^{\circ}C \leq T_J \leq 125^{\circ}C$	--	-1	--	$mV/^{\circ}C$	

- Pulse testing techniques are used to maintain the junction temperature as close to the ambient temperature as possible, and thermal effects must be taken into account separately.
- This specification applies only for DC power dissipation permitted by absolute maximum ratings.

Electrical Characteristics Curves

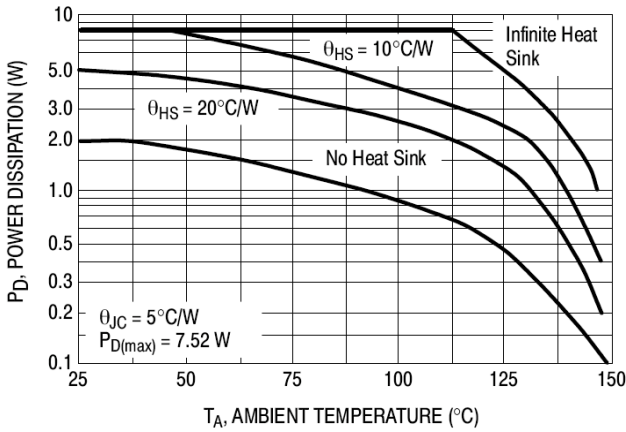

Figure 1. Worst Case Power Dissipation vs. Ambient Temperature (TO-220)

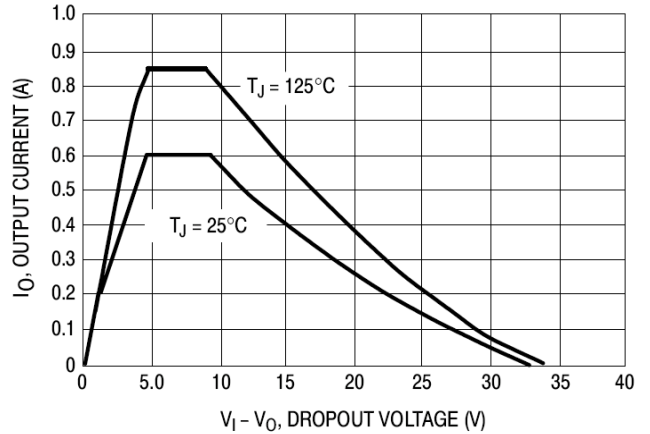

Figure 2. Peak Output Current as a Function of Input-Output Differential Voltage

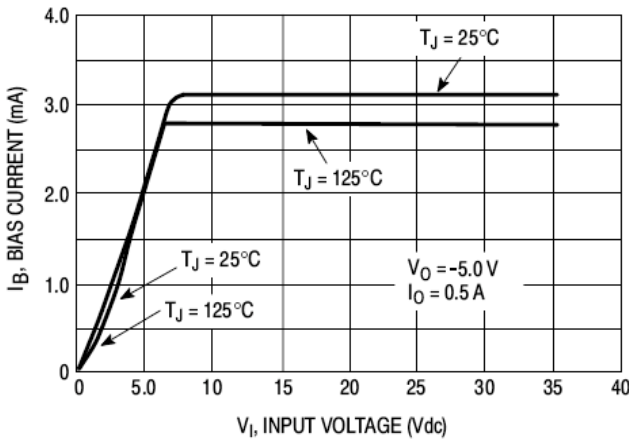

Figure 3. Bias Current vs. Input Voltage

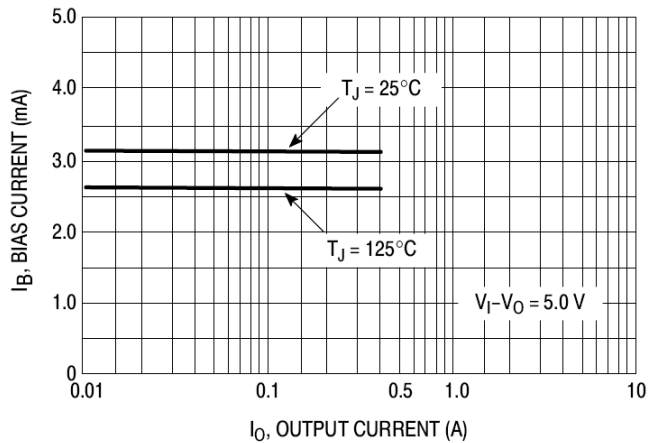

Figure 4. Bias Current vs. Output Current

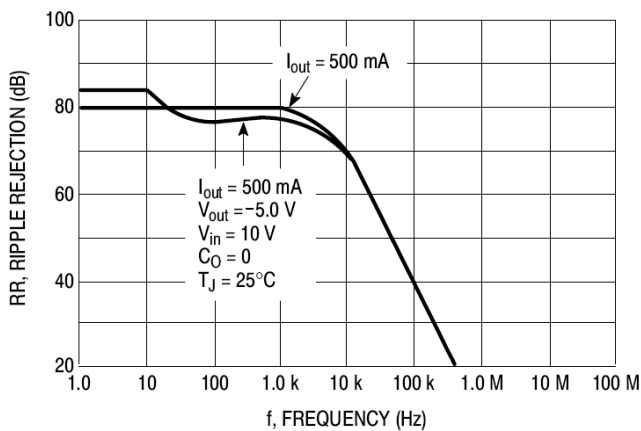

Figure 5. Ripple Rejection vs. Frequency

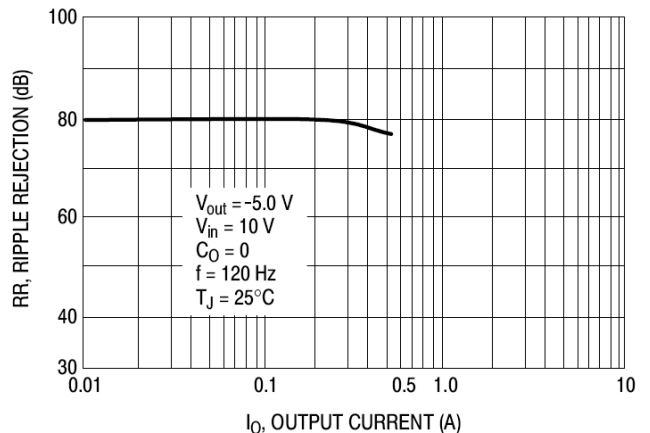

Figure 6. Ripple Rejection vs. Output Voltage

Application information

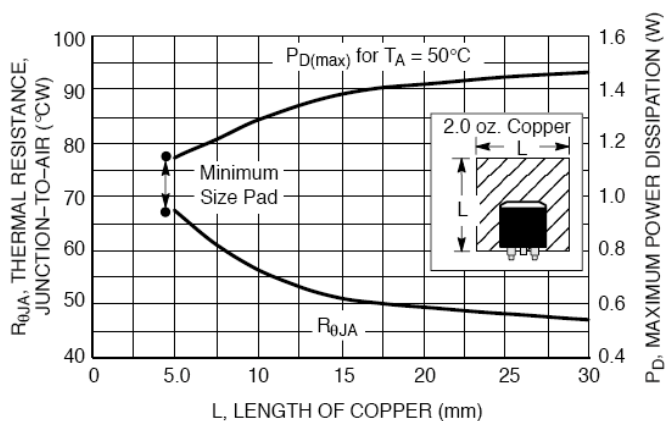

Figure 7. DPAK Thermal Resistance and Maximum Power Dissipation vs. P.C.B Copper Length

Ordering information

Voltage	TO-220	TO-252
5V	TS79M05CZ C0	TS79M05CP RO
12V		TS79M12CP RO

Packing code information

Packing	50pcs / Tube	2.5kpcs / 13" Reel
---------	--------------	--------------------

TO-220 Mechanical Drawing

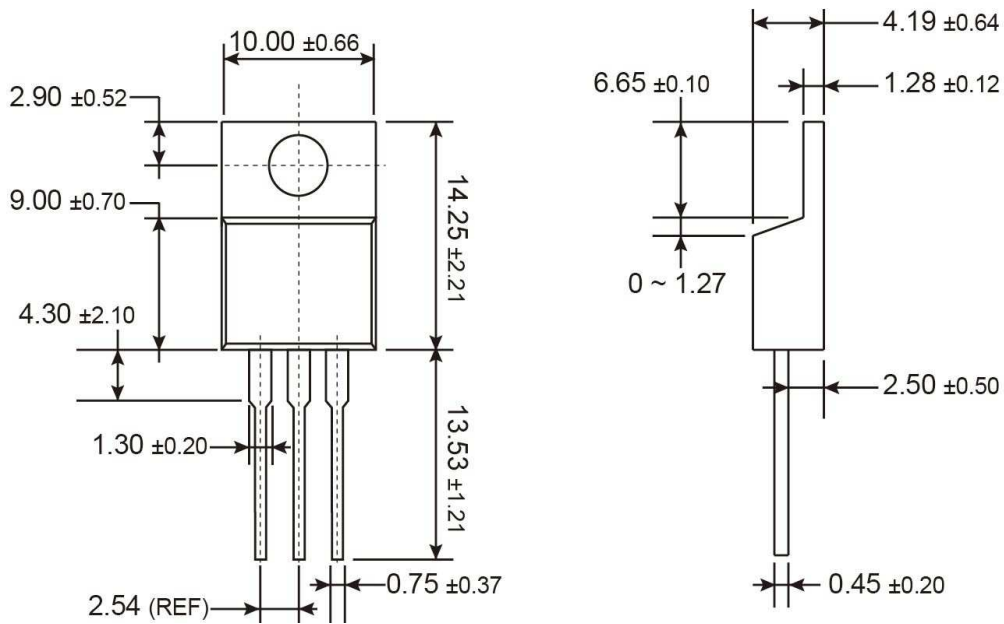

Unit: Millimeters

Marking Diagram

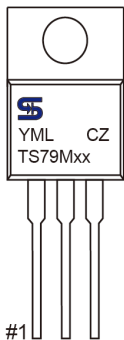

- XX** = Output Voltage
(05=-5V)
- Y** = Year Code
- M** = Month Code
(A=Jan, B=Feb, C=Mar, D=Apl, E=May, F=Jun, G=Jul, H=Aug, I=Sep, J=Oct, K=Nov, L=Dec)
- L** = Lot Code
- CZ** = Package Code for TO-220

TO-252 Mechanical Drawing

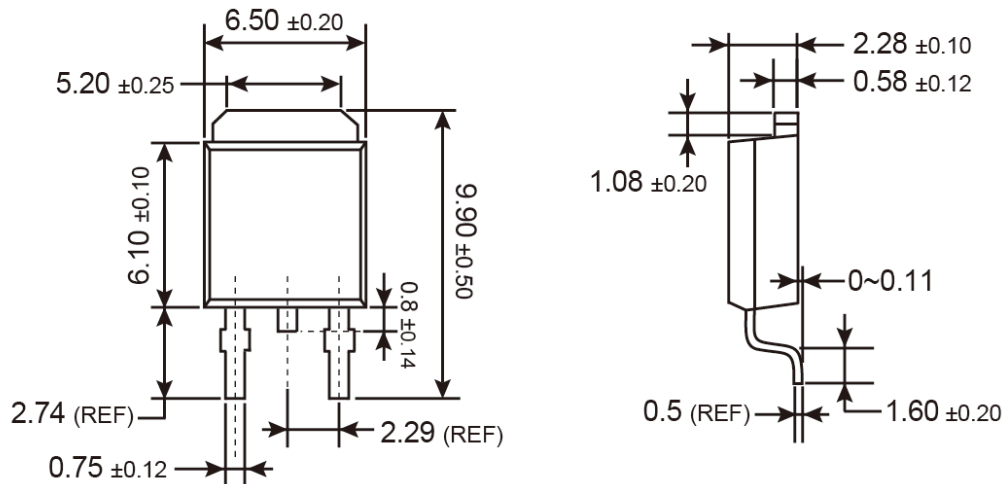

Unit: Millimeters

Marking Diagram

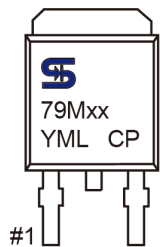

- XX** = Output Voltage
(**05**=-5V, **12**=-12V)
- Y** = Year Code
- M** = Month Code
(**A**=Jan, **B**=Feb, **C**=Mar, **D**=Apr, **E**=May, **F**=Jun, **G**=Jul, **H**=Aug, **I**=Sep, **J**=Oct, **K**=Nov, **L**=Dec)
- L** = Lot Code
- CP** = Package Code for TO-252

TS79M00 Series

3-Terminal 500mA Negative Voltage Regulator

Notice

Specifications of the products displayed herein are subject to change without notice. TSC or anyone on its behalf, assumes no responsibility or liability for any errors or inaccuracies.

Information contained herein is intended to provide a product description only. No license, express or implied, to any intellectual property rights is granted by this document. Except as provided in TSC's terms and conditions of sale for such products, TSC assumes no liability whatsoever, and disclaims any express or implied warranty, relating to sale and/or use of TSC products including liability or warranties relating to fitness for a particular purpose, merchantability, or infringement of any patent, copyright, or other intellectual property right.

The products shown herein are not designed for use in medical, life-saving, or life-sustaining applications. Customers using or selling these products for use in such applications do so at their own risk and agree to fully indemnify TSC for any damages resulting from such improper use or sale.