

FGH40T100SMD

1000 V, 40 A Field Stop Trench IGBT

Features

- High Current Capability
- Low Saturation Voltage: $V_{CE(sat)} = 1.9\text{ V(Typ.)}$ @ $I_C = 40\text{ A}$
- High Input Impedance
- Fast Switching
- RoHS Compliant

Applications

- UPS, welder, PFC

General Description

Using innovative field stop trench IGBT technology, Fairchild's new series of field stop trench IGBTs offer the optimum performance for hard switching application such as UPS, welder and PFC applications.

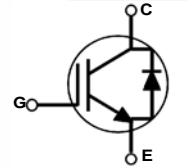
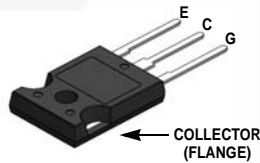

Absolute Maximum Ratings

Symbol	Description	Ratings	Unit
V_{CES}	Collector to Emitter Voltage	1000	V
V_{GES}	Gate to Emitter Voltage	± 25	V
	Transient Gate to Emitter Voltage	± 30	V
I_C	Collector Current @ $T_C = 25^\circ\text{C}$	80	A
	Collector Current @ $T_C = 100^\circ\text{C}$	40	A
$I_{CM(1)}$	Pulsed Collector Current @ $T_C = 25^\circ\text{C}$	120	A
I_F	Diode Forward Current @ $T_C = 25^\circ\text{C}$	80	A
	Diode Forward Current @ $T_C = 100^\circ\text{C}$	40	A
$I_{FM(1)}$	Pulsed Diode Forward Current @ $T_C = 25^\circ\text{C}$	120	A
P_D	Maximum Power Dissipation @ $T_C = 25^\circ\text{C}$	333	W
	Maximum Power Dissipation @ $T_C = 100^\circ\text{C}$	166	W
T_J	Operating Junction Temperature	-55 to +175	$^\circ\text{C}$
T_{stg}	Storage Temperature Range	-55 to +175	$^\circ\text{C}$
T_L	Maximum Lead Temp. for soldering Purposes, 1/8" from case for 5 seconds	300	$^\circ\text{C}$

Notes:

1: Repetitive rating: Pulse width limited by max. junction temperature

Thermal Characteristics

Symbol	Parameter	Typ.	Max.	Unit
$R_{\theta JC}(\text{IGBT})$	Thermal Resistance, Junction to Case	-	0.45	$^\circ\text{C/W}$
$R_{\theta JC}(\text{Diode})$	Thermal Resistance, Junction to Case	-	0.8	$^\circ\text{C/W}$
$R_{\theta JA}$	Thermal Resistance, Junction to Ambient	-	40	$^\circ\text{C/W}$

Package Marking and Ordering Information

Device Marking	Device	Package	Reel Size	Tape Width	Quantity
FGH40T100SMD	FGH40T100SMD	TO-247	-	-	30ea

Electrical Characteristics of the IGBT T_C = 25°C unless otherwise noted

Symbol	Parameter	Test Conditions	Min.	Typ.	Max.	Unit
Off Characteristics						
BV_{CES}	Collector to Emitter Breakdown Voltage	$V_{GE} = 0\text{ V}, I_C = 1\text{ mA}$	1000	-	-	V
$\frac{\Delta BV_{CES}}{\Delta T_J}$	Temperature Coefficient of Breakdown Voltage	$V_{GE} = 0\text{ V}, I_C = 250\text{ }\mu\text{A}$	-	0.6	-	V/°C
I_{CES}	Collector Cut-Off Current	$V_{CE} = V_{CES}, V_{GE} = 0\text{ V}$	-	-	1000	μA
I_{GES}	G-E Leakage Current	$V_{GE} = V_{GES}, V_{CE} = 0\text{ V}$	-	-	± 500	nA
On Characteristics						
$V_{GE(th)}$	G-E Threshold Voltage	$I_C = 250\text{ }\mu\text{A}, V_{CE} = V_{GE}$	4.2	5.3	6.5	V
$V_{CE(sat)}$	Collector to Emitter Saturation Voltage	$I_C = 40\text{ A}, V_{GE} = 15\text{ V}$	-	1.9	2.3	V
		$I_C = 40\text{ A}, V_{GE} = 15\text{ V}, T_C = 175^\circ\text{C}$	-	2.4	-	V
Dynamic Characteristics						
C_{ies}	Input Capacitance	$V_{CE} = 30\text{ V}, V_{GE} = 0\text{ V}, f = 1\text{ MHz}$	-	3980	5295	pF
C_{oes}	Output Capacitance		-	124	165	pF
C_{res}	Reverse Transfer Capacitance		-	76	115	pF
Switching Characteristics						
$t_{d(on)}$	Turn-On Delay Time	$V_{CC} = 600\text{ V}, I_C = 40\text{ A}, R_G = 10\text{ }\Omega, V_{GE} = 15\text{ V}, \text{Inductive Load}, T_C = 25^\circ\text{C}$	-	29	38	ns
t_r	Rise Time		-	42	55	ns
$t_{d(off)}$	Turn-Off Delay Time		-	285	371	ns
t_f	Fall Time		-	23	30	ns
E_{on}	Turn-On Switching Loss		-	2.35	3.1	mJ
E_{off}	Turn-Off Switching Loss		-	1.15	1.5	mJ
E_{ts}	Total Switching Loss		-	3.5	4.6	mJ
$t_{d(on)}$	Turn-On Delay Time	$V_{CC} = 600\text{ V}, I_C = 40\text{ A}, R_G = 10\text{ }\Omega, V_{GE} = 15\text{ V}, \text{Inductive Load}, T_C = 175^\circ\text{C}$	-	27	36	ns
t_r	Rise Time		-	49	64	ns
$t_{d(off)}$	Turn-Off Delay Time		-	285	371	ns
t_f	Fall Time		-	20	26	ns
E_{on}	Turn-On Switching Loss		-	4.4	5.7	mJ
E_{off}	Turn-Off Switching Loss		-	1.9	2.5	mJ
E_{ts}	Total Switching Loss		-	6.3	8.2	mJ
Q_g	Total Gate Charge	$V_{CE} = 600\text{ V}, I_C = 40\text{ A}, V_{GE} = 15\text{ V}$	-	265	398	nC
Q_{ge}	Gate to Emitter Charge		-	32	48	nC
Q_{gc}	Gate to Collector Charge		-	135	203	nC

Electrical Characteristics of Diode T_C = 25°C unless otherwise noted

Symbol	Parameter	Test Conditions	Min.	Typ.	Max	Unit	
V _{FM}	Diode Forward Voltage	I _F = 40 A	T _C = 25°C	-	3.4	4.4	V
			T _C = 175°C	-	2.6	-	
t _{rr}	Diode Reverse Recovery Time	I _F = 40 A, dI _F /dt = 200 A/μs	T _C = 25°C	-	60	78	ns
			T _C = 175°C	-	256	-	
Q _{rr}	Diode Reverse Recovery Charge	I _F = 40 A, dI _F /dt = 200 A/μs	T _C = 25°C	-	185	260	nC
			T _C = 175°C	-	1512	-	



Typical Performance Characteristics

Figure 1. Typical Output Characteristics

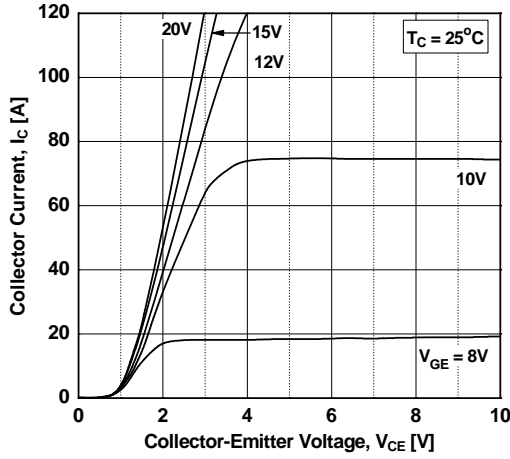

Figure 2. Typical Output Characteristics

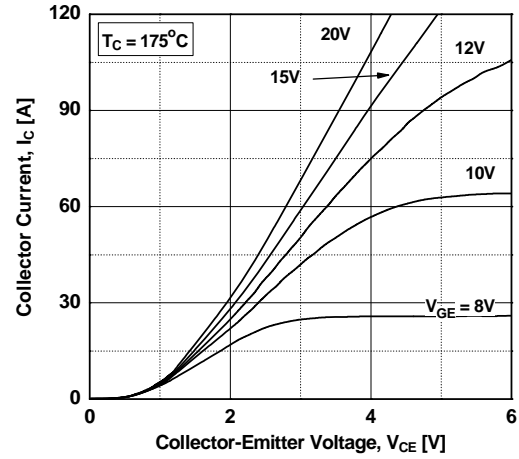

Figure 3. Typical Saturation Voltage Characteristics

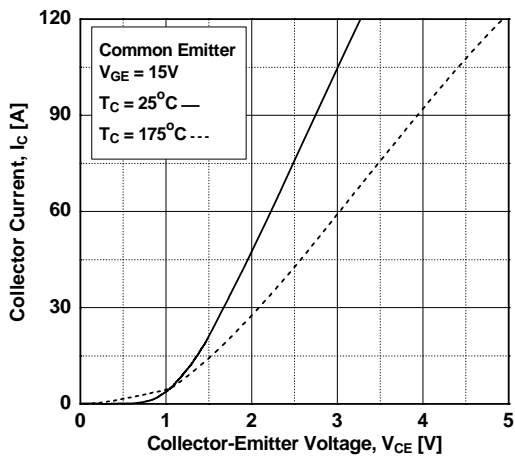

Figure 4. Saturation Voltage vs. Case Temperature at Variant Current Level

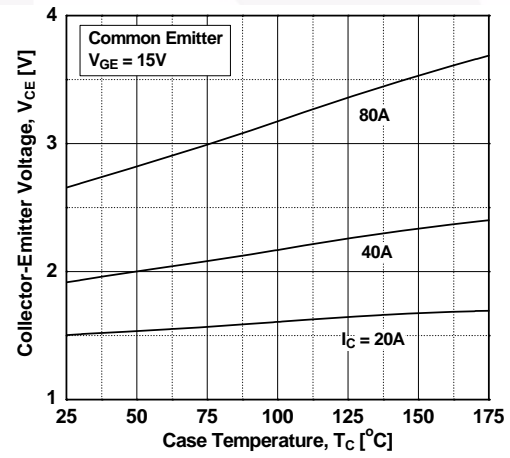

Figure 5. Saturation Voltage vs. Vge

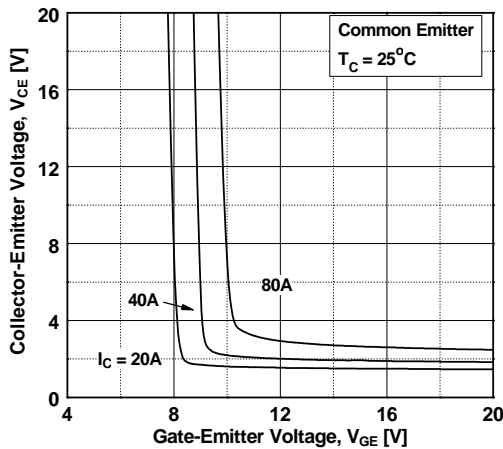
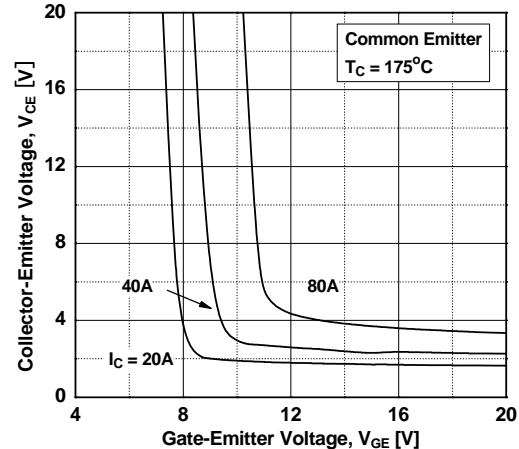

Figure 6. Saturation Voltage vs. Vge



Typical Performance Characteristics

Figure 7. Capacitance Characteristics

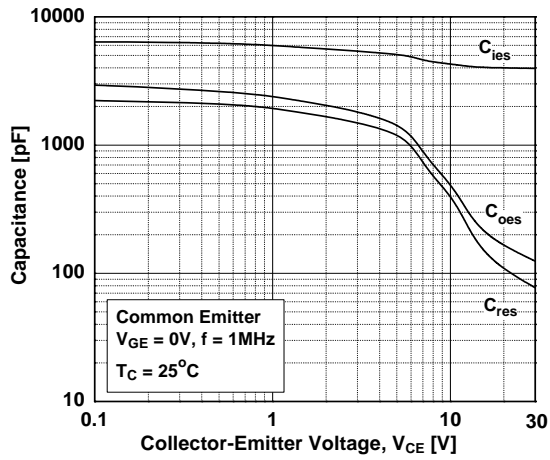

Figure 8. Gate charge Characteristics

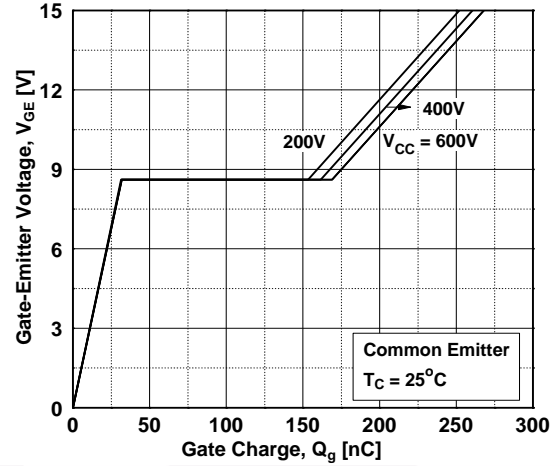

Figure 9. Turn-on Characteristics vs. Gate Resistance

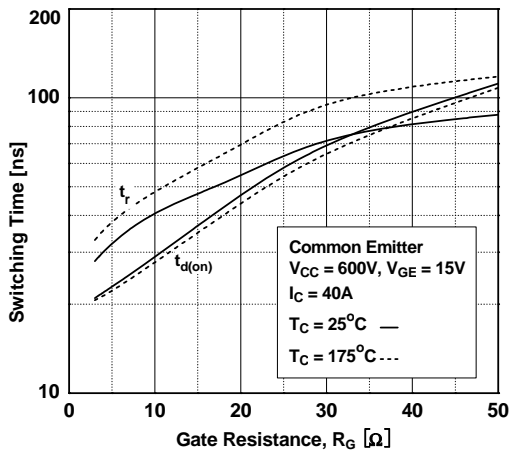

Figure 10. Turn-off Characteristics vs. Gate Resistance

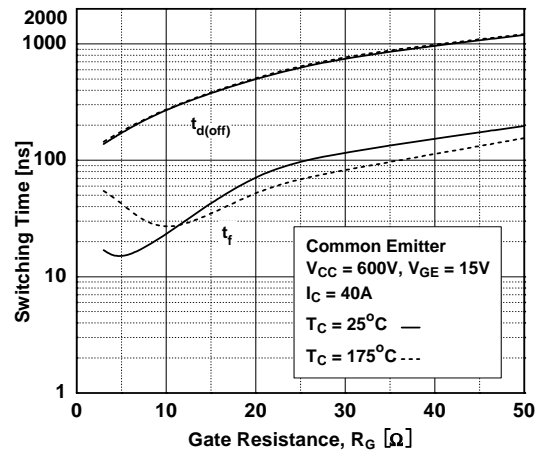

Figure 11. Switching Loss vs. Gate Resistance

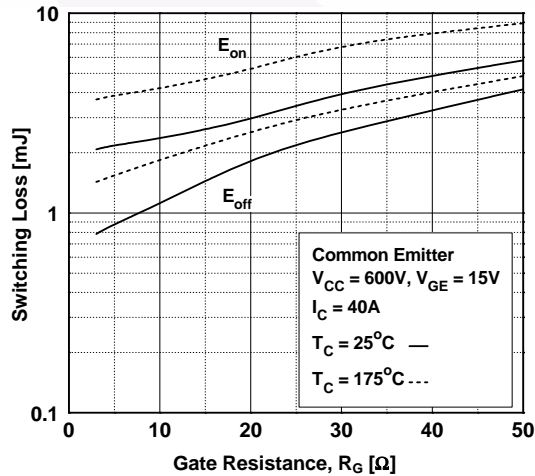
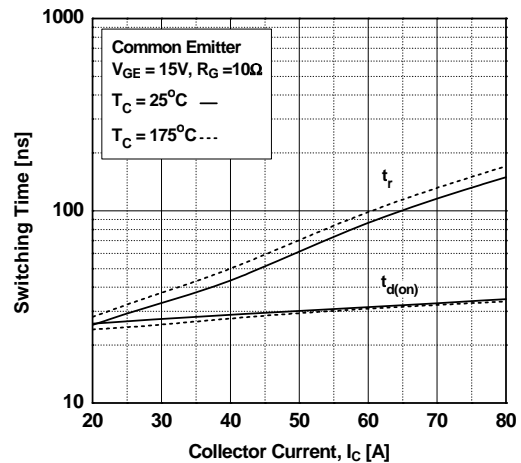

Figure 12. Turn-on Characteristics vs. Collector Current



Typical Performance Characteristics

Figure 13. Turn-off Characteristics vs. Collector Current

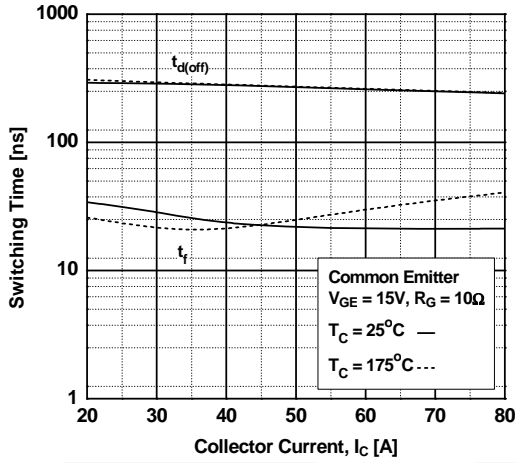

Figure 15. Load Current Vs. Frequency

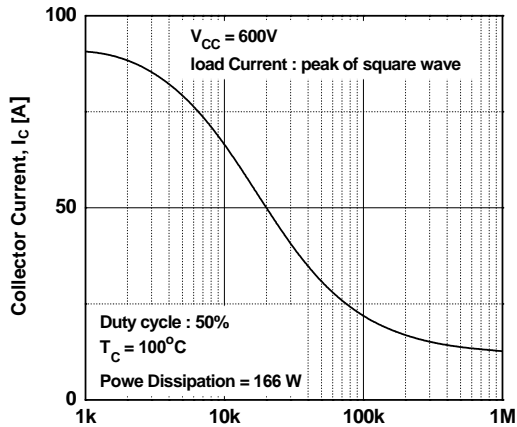

Figure 17. Forward Characteristics

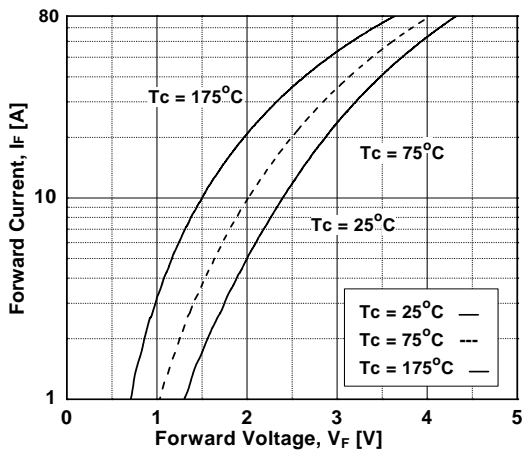

Figure 14. Switching Loss vs. Collector Current

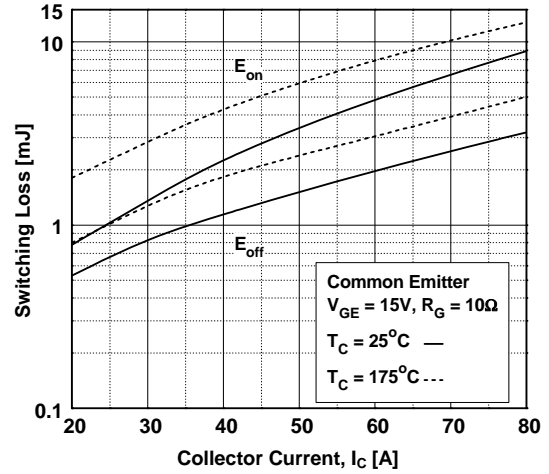

Figure 16. SOA Characteristics

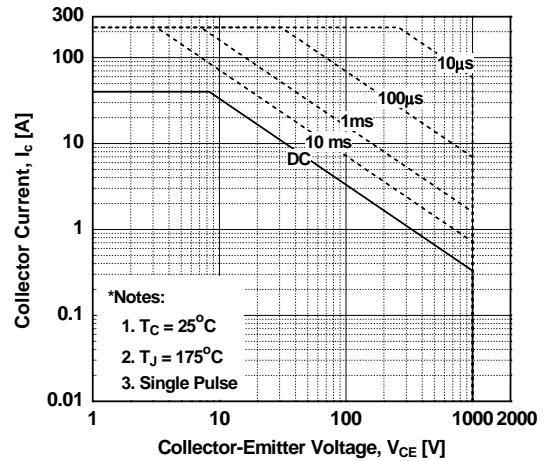
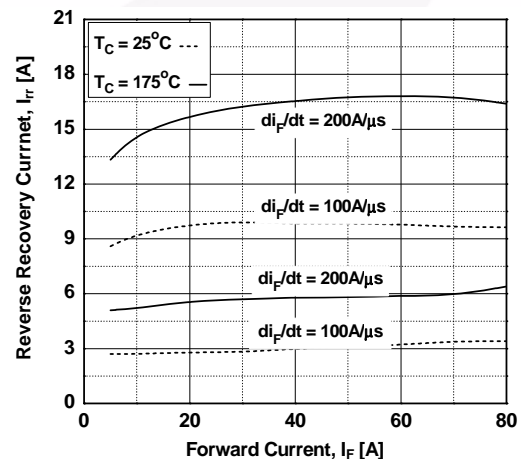

Figure 18. Reverse Recovery Current



Typical Performance Characteristics

Figure 19. Reverse Recovery Time

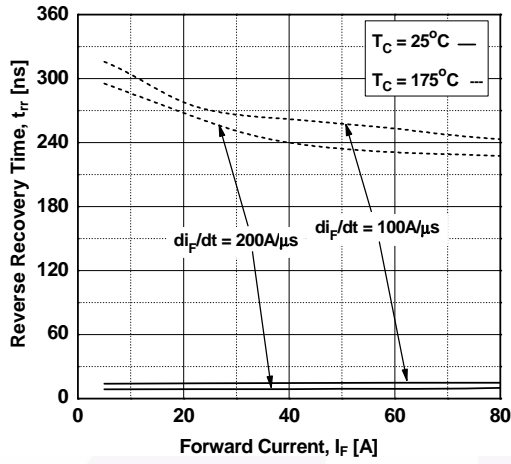

Figure 20. Stored Charge

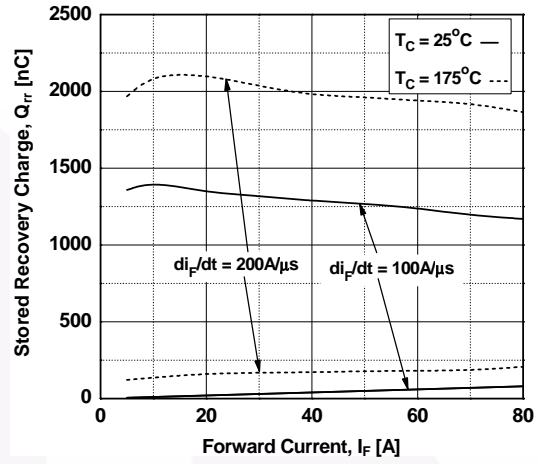

Figure 21. Transient Thermal Impedance of IGBT

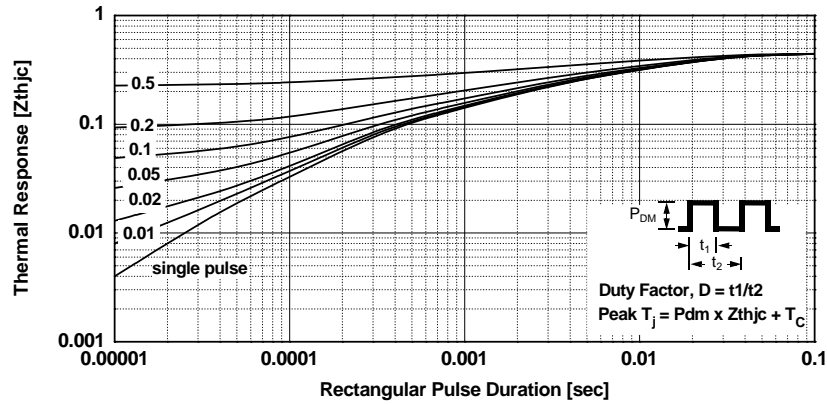
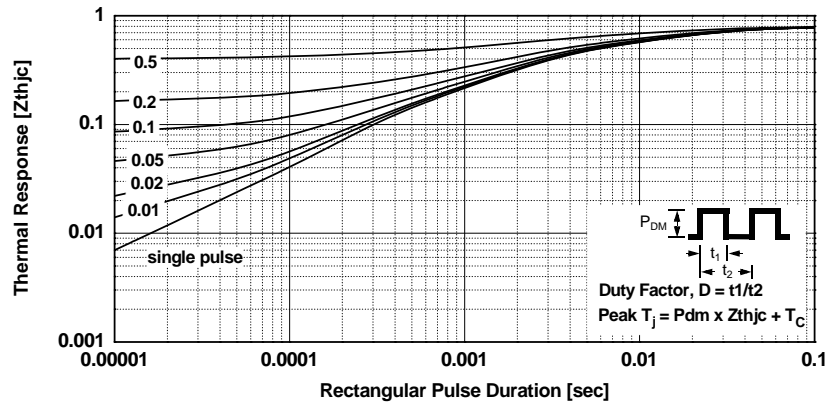
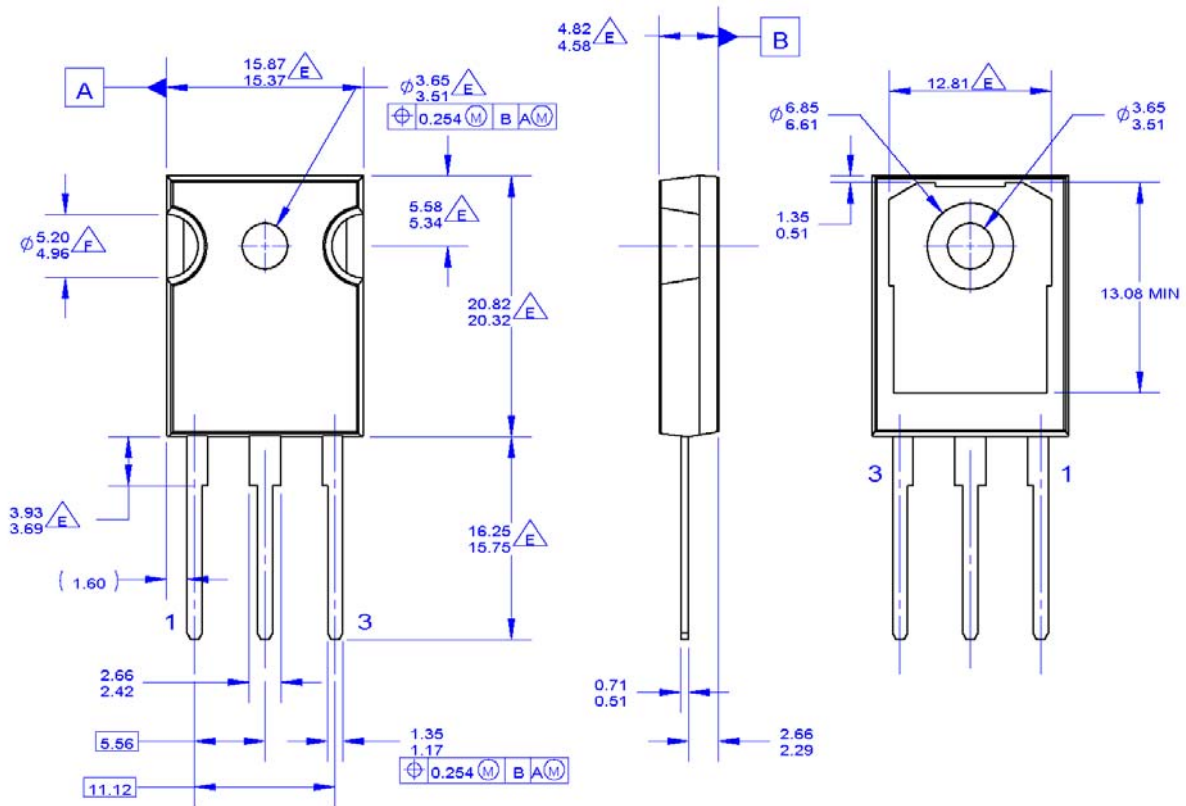

Figure 22. Transient Thermal Impedance of Diode



Mechanical Dimensions



NOTES: UNLESS OTHERWISE SPECIFIED.

- A. PACKAGE REFERENCE: JEDEC TO-247, ISSUE E, VARIATION AB, DATED JUNE, 2004.
- B. DIMENSIONS ARE EXCLUSIVE OF BURRS, MOLD FLASH, AND TIE BAR EXTRUSIONS.
- C. ALL DIMENSIONS ARE IN MILLIMETERS.
- D. DRAWING CONFORMS TO ASME Y14.5 - 1994
- DOES NOT COMPLY JEDEC STANDARD VALUE
- NOTCH MAY BE SQUARE
- G. DRAWING FILENAME: MKT-T0247A03_REV03

Figure 23. TO-247,MOLDED,3 LEAD,JEDEC VARIATION AB (Active)

Package drawings are provided as a service to customers considering Fairchild components. Drawings may change in any manner without notice. Please note the revision and/or date on the drawing and contact a Fairchild Semiconductor representative to verify or obtain the most recent revision. Package specifications do not expand the terms of Fairchild's worldwide terms and conditions, specifically the warranty therein, which covers Fairchild products.

Always visit Fairchild Semiconductor's online packaging area for the most recent package drawings:



http://www.fairchildsemi.com/package/packageDetails.html?id=PN_T0247-003

Dimensions in Millimeters



TRADEMARKS

The following includes registered and unregistered trademarks and service marks, owned by Fairchild Semiconductor and/or its global subsidiaries, and is not intended to be an exhaustive list of all such trademarks.

- | | | | |
|--|---|---|---|
| AccuPower™ | F-PFST™ | PowerTrench® | Sync-Lock™ |
| AX-CAP®* | FRFET® | PowerXS™ | SYSTEM GENERAL ®* |
| BitSiC™ | Global Power Resource SM | Programmable Active Droop™ | TinyBoost® |
| Build it Now™ | GreenBridge™ | QFET® | TinyBuck® |
| CorePLUS™ | Green FPS™ | QS™ | TinyCalc™ |
| CorePOWER™ | Green FPS™ e-Series™ | Quiet Series™ | TinyLogic® |
| CROSSVOLT™ | Gmax™ | RapidConfigure™ | TINYOPTO™ |
| CTL™ | GTO™ | | TinyPower™ |
| Current Transfer Logic™ | IntelliMAX™ | | TinyPWM™ |
| DEUXPEED® | ISOPLANAR™ | | TinyWire™ |
| Dual Cool™ | Marking Small Speakers Sound Louder and Better™ |  Saving our world, 1mW/W/kW at a time™ | TranSiC™ |
| EcoSPARK® | MegaBuck™ | SignalWise™ | TriFault Detect™ |
| EfficientMax™ | MICROCOUPLER™ | SmartMax™ | TRUECURRENT®* |
| ESBC™ | MicroFET™ | SMART START™ | μSerDes™ |
|  Fairchild® | MicroPak™ | Solutions for Your Success™ |  SerDes™ |
| Fairchild Semiconductor® | MicroPak2™ | SPM® | UHC® |
| FACT Quiet Series™ | MillerDrive™ | STEALTH™ | Ultra FRFET™ |
| FACT® | MotionMax™ | SuperFET® | UniFET™ |
| FAST® | mWSaver® | SuperSOT™-3 | VCX™ |
| FastvCore™ | OptoHit™ | SuperSOT™-6 | VisualMax™ |
| FETBench™ | OPTOLOGIC® | SuperSOT™-8 | VoltagePlus™ |
| FPS™ | OPTOPLANAR® | SupreMOS® | XS™ |
| | | SyncFET™ | |

*Trademarks of System General Corporation, used under license by Fairchild Semiconductor.

DISCLAIMER

FAIRCHILD SEMICONDUCTOR RESERVES THE RIGHT TO MAKE CHANGES WITHOUT FURTHER NOTICE TO ANY PRODUCTS HEREIN TO IMPROVE RELIABILITY, FUNCTION, OR DESIGN. FAIRCHILD DOES NOT ASSUME ANY LIABILITY ARISING OUT OF THE APPLICATION OR USE OF ANY PRODUCT OR CIRCUIT DESCRIBED HEREIN; NEITHER DOES IT CONVEY ANY LICENSE UNDER ITS PATENT RIGHTS, NOR THE RIGHTS OF OTHERS. THESE SPECIFICATIONS DO NOT EXPAND THE TERMS OF FAIRCHILD'S WORLDWIDE TERMS AND CONDITIONS, SPECIFICALLY THE WARRANTY THEREIN, WHICH COVERS THESE PRODUCTS.

LIFE SUPPORT POLICY

FAIRCHILD'S PRODUCTS ARE NOT AUTHORIZED FOR USE AS CRITICAL COMPONENTS IN LIFE SUPPORT DEVICES OR SYSTEMS WITHOUT THE EXPRESS WRITTEN APPROVAL OF FAIRCHILD SEMICONDUCTOR CORPORATION.

As used here in:

- Life support devices or systems are devices or systems which, (a) are intended for surgical implant into the body or (b) support or sustain life, and (c) whose failure to perform when properly used in accordance with instructions for use provided in the labeling, can be reasonably expected to result in a significant injury of the user.
- A critical component in any component of a life support, device, or system whose failure to perform can be reasonably expected to cause the failure of the life support device or system, or to affect its safety or effectiveness.

ANTI-COUNTERFEITING POLICY

Fairchild Semiconductor Corporation's Anti-Counterfeiting Policy. Fairchild's Anti-Counterfeiting Policy is also stated on our external website, www.fairchildsemi.com, under Sales Support.

Counterfeiting of semiconductor parts is a growing problem in the industry. All manufactures of semiconductor products are experiencing counterfeiting of their parts. Customers who inadvertently purchase counterfeit parts experience many problems such as loss of brand reputation, substandard performance, failed application, and increased cost of production and manufacturing delays. Fairchild is taking strong measures to protect ourselves and our customers from the proliferation of counterfeit parts. Fairchild strongly encourages customers to purchase Fairchild parts either directly from Fairchild or from Authorized Fairchild Distributors who are listed by country on our web page cited above. Products customers buy either from Fairchild directly or from Authorized Fairchild Distributors are genuine parts, have full traceability, meet Fairchild's quality standards for handling and storage and provide access to Fairchild's full range of up-to-date technical and product information. Fairchild and our Authorized Distributors will stand behind all warranties and will appropriately address and warranty issues that may arise. Fairchild will not provide any warranty coverage or other assistance for parts bought from Unauthorized Sources. Fairchild is committed to combat this global problem and encourage our customers to do their part in stopping this practice by buying direct or from authorized distributors.

PRODUCT STATUS DEFINITIONS

Definition of Terms

Datasheet Identification	Product Status	Definition
Advance Information	Formative / In Design	Datasheet contains the design specifications for product development. Specifications may change in any manner without notice.
Preliminary	First Production	Datasheet contains preliminary data; supplementary data will be published at a later date. Fairchild Semiconductor reserves the right to make changes at any time without notice to improve design.
No Identification Needed	Full Production	Datasheet contains final specifications. Fairchild Semiconductor reserves the right to make changes at any time without notice to improve the design.
Obsolete	Not In Production	Datasheet contains specifications on a product that is discontinued by Fairchild Semiconductor. The datasheet is for reference information only.

Rev. I66