



Is Now Part of



**ON Semiconductor®**

To learn more about ON Semiconductor, please visit our website at  
[www.onsemi.com](http://www.onsemi.com)

Please note: As part of the Fairchild Semiconductor integration, some of the Fairchild orderable part numbers will need to change in order to meet ON Semiconductor's system requirements. Since the ON Semiconductor product management systems do not have the ability to manage part nomenclature that utilizes an underscore (\_), the underscore (\_) in the Fairchild part numbers will be changed to a dash (-). This document may contain device numbers with an underscore (\_). Please check the ON Semiconductor website to verify the updated device numbers. The most current and up-to-date ordering information can be found at [www.onsemi.com](http://www.onsemi.com). Please email any questions regarding the system integration to [Fairchild\\_questions@onsemi.com](mailto:Fairchild_questions@onsemi.com).

ON Semiconductor and the ON Semiconductor logo are trademarks of Semiconductor Components Industries, LLC dba ON Semiconductor or its subsidiaries in the United States and/or other countries. ON Semiconductor owns the rights to a number of patents, trademarks, copyrights, trade secrets, and other intellectual property. A listing of ON Semiconductor's product/patent coverage may be accessed at [www.onsemi.com/site/pdf/Patent-Marking.pdf](http://www.onsemi.com/site/pdf/Patent-Marking.pdf). ON Semiconductor reserves the right to make changes without further notice to any products herein. ON Semiconductor makes no warranty, representation or guarantee regarding the suitability of its products for any particular purpose, nor does ON Semiconductor assume any liability arising out of the application or use of any product or circuit, and specifically disclaims any and all liability, including without limitation special, consequential or incidental damages. Buyer is responsible for its products and applications using ON Semiconductor products, including compliance with all laws, regulations and safety requirements or standards, regardless of any support or applications information provided by ON Semiconductor. "Typical" parameters which may be provided in ON Semiconductor data sheets and/or specifications can and do vary in different applications and actual performance may vary over time. All operating parameters, including "Typicals" must be validated for each customer application by customer's technical experts. ON Semiconductor does not convey any license under its patent rights nor the rights of others. ON Semiconductor products are not designed, intended, or authorized for use as a critical component in life support systems or any FDA Class 3 medical devices or medical devices with a same or similar classification in a foreign jurisdiction or any devices intended for implantation in the human body. Should Buyer purchase or use ON Semiconductor products for any such unintended or unauthorized application, Buyer shall indemnify and hold ON Semiconductor and its officers, employees, subsidiaries, affiliates, and distributors harmless against all claims, costs, damages, and expenses, and reasonable attorney fees arising out of, directly or indirectly, any claim of personal injury or death associated with such unintended or unauthorized use, even if such claim alleges that ON Semiconductor was negligent regarding the design or manufacture of the part. ON Semiconductor is an Equal Opportunity/Affirmative Action Employer. This literature is subject to all applicable copyright laws and is not for resale in any manner.

# FQD2N100 / FQU2N100

## N-Channel QFET® MOSFET

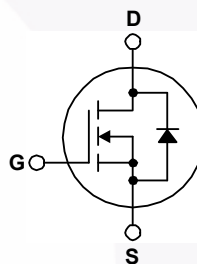
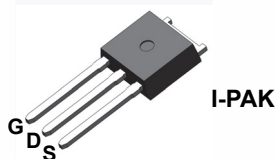
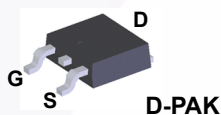
1000 V, 1.6 A, 9 Ω

### Description

This N-Channel enhancement mode power MOSFET is produced using Fairchild Semiconductor's proprietary planar stripe and DMOS technology. This advanced MOSFET technology has been especially tailored to reduce on-state resistance, and to provide superior switching performance and high avalanche energy strength. These devices are suitable for switched mode power supplies, active power factor correction (PFC), and electronic lamp ballasts.

### Features

- 1.6 A, 1000 V,  $R_{DS(on)} = 9 \Omega$  (Max.) @  $V_{GS} = 10 V$ ,  $I_D = 0.8 A$
- Low Gate Charge (Typ. 12 nC)
- Low Crss (Typ. 5 pF)
- 100% Avalanche Tested
- RoHS Compliant



### Absolute Maximum Ratings

$T_C = 25^\circ C$  unless otherwise noted

Symbol	Parameter	FQD2N100TM / FQU2N100TU	Unit
$V_{DSS}$	Drain-Source Voltage	1000	V
$I_D$	Drain Current - Continuous ( $T_C = 25^\circ C$ )	1.6	A
	Drain Current - Continuous ( $T_C = 100^\circ C$ )	1.0	A
$I_{DM}$	Drain Current - Pulsed (Note 1)	6.4	A
$V_{GSS}$	Gate-Source Voltage	$\pm 30$	V
$E_{AS}$	Single Pulsed Avalanche Energy (Note 2)	160	mJ
$I_{AR}$	Avalanche Current (Note 1)	1.6	A
$E_{AR}$	Repetitive Avalanche Energy (Note 1)	5.0	mJ
dv/dt	Peak Diode Recovery dv/dt (Note 3)	5.5	V/ns
$P_D$	Power Dissipation ( $T_A = 25^\circ C$ ) *	2.5	W
	Power Dissipation ( $T_C = 25^\circ C$ )	50	W
	- Derate above $25^\circ C$	0.4	W/ $^\circ C$
$T_J, T_{STG}$	Operating and Storage Temperature Range	-55 to +150	$^\circ C$
$T_L$	Maximum lead temperature for soldering purposes, 1/8" from case for 5 seconds	300	$^\circ C$

### Thermal Characteristics

Symbol	Parameter	FQD2N100TM / FQU2N100TU	Unit
$R_{\theta JC}$	Thermal Resistance, Junction to Case, Max.	2.5	$^\circ C/W$
$R_{\theta JA}$	Thermal Resistance, Junction to Ambient (minimum pad of 2 oz copper), Max.	110	
	Thermal Resistance, Junction to Ambient (* 1 in <sup>2</sup> pad of 2 oz copper), Max.	50	

## Package Marking and Ordering Information

Device Marking	Device	Package	Reel Size	Tape Width	Quantity
FQD2N100	FQD2N100TM	DPAK	330 mm	16 mm	2500
FQU2N100	FQU2N100TU	IPAK	-	-	70

## Electrical Characteristics

$T_C = 25^\circ\text{C}$  unless otherwise noted

Symbol	Parameter	Test Conditions	Min	Typ	Max	Unit
<b>Off Characteristics</b>						
$BV_{DSS}$	Drain-Source Breakdown Voltage	$V_{GS} = 0\text{ V}, I_D = 250\ \mu\text{A}$	1000	--	--	V
$\Delta BV_{DSS} / \Delta T_J$	Breakdown Voltage Temperature Coefficient	$I_D = 250\ \mu\text{A}$ , Referenced to $25^\circ\text{C}$	--	0.976	--	$\text{V}/^\circ\text{C}$
$I_{DSS}$	Zero Gate Voltage Drain Current	$V_{DS} = 1000\text{ V}, V_{GS} = 0\text{ V}$	--	--	10	$\mu\text{A}$
		$V_{DS} = 800\text{ V}, T_C = 125^\circ\text{C}$	--	--	100	$\mu\text{A}$
$I_{GSSF}$	Gate-Body Leakage Current, Forward	$V_{GS} = 30\text{ V}, V_{DS} = 0\text{ V}$	--	--	100	nA
$I_{GSSR}$	Gate-Body Leakage Current, Reverse	$V_{GS} = -30\text{ V}, V_{DS} = 0\text{ V}$	--	--	-100	nA

### On Characteristics

$V_{GS(th)}$	Gate Threshold Voltage	$V_{DS} = V_{GS}, I_D = 250\ \mu\text{A}$	3.0	--	5.0	V
$R_{DS(on)}$	Static Drain-Source On-Resistance	$V_{GS} = 10\text{ V}, I_D = 0.8\text{ A}$	--	7.1	9	$\Omega$
$g_{FS}$	Forward Transconductance	$V_{DS} = 50\text{ V}, I_D = 0.8\text{ A}$	--	1.9	--	S

### Dynamic Characteristics

$C_{iss}$	Input Capacitance	$V_{DS} = 25\text{ V}, V_{GS} = 0\text{ V}, f = 1.0\text{ MHz}$	--	400	520	pF
$C_{oss}$	Output Capacitance		--	40	52	pF
$C_{rss}$	Reverse Transfer Capacitance		--	5	6.5	pF

### Switching Characteristics

$t_{d(on)}$	Turn-On Delay Time	$V_{DD} = 500\text{ V}, I_D = 2.0\text{ A}, R_G = 25\ \Omega$	--	13	35	ns	
$t_r$	Turn-On Rise Time		--	30	70	ns	
$t_{d(off)}$	Turn-Off Delay Time		--	25	60	ns	
$t_f$	Turn-Off Fall Time		(Note 4)	--	35	80	ns
$Q_g$	Total Gate Charge	$V_{DS} = 800\text{ V}, I_D = 2.0\text{ A}, V_{GS} = 10\text{ V}$	--	12	15.5	nC	
$Q_{gs}$	Gate-Source Charge		(Note 4)	--	2.5	--	nC
$Q_{gd}$	Gate-Drain Charge		(Note 4)	--	6.5	--	nC

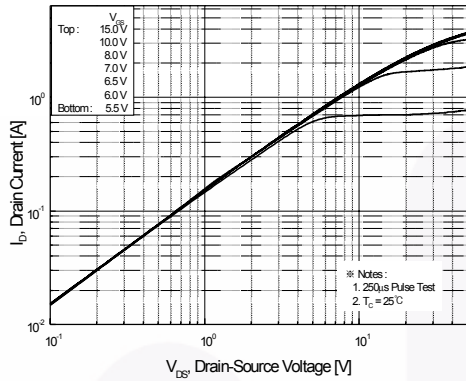
### Drain-Source Diode Characteristics and Maximum Ratings

$I_S$	Maximum Continuous Drain-Source Diode Forward Current	--	--	1.5	A	
$I_{SM}$	Maximum Pulsed Drain-Source Diode Forward Current	--	--	6.0	A	
$V_{SD}$	Drain-Source Diode Forward Voltage	$V_{GS} = 0\text{ V}, I_S = 1.6\text{ A}$	--	--	1.4	V
$t_{rr}$	Reverse Recovery Time	$V_{GS} = 0\text{ V}, I_S = 2.0\text{ A}$	--	520	--	ns
$Q_{rr}$	Reverse Recovery Charge	$dI_F / dt = 100\text{ A}/\mu\text{s}$	--	2.3	--	$\mu\text{C}$

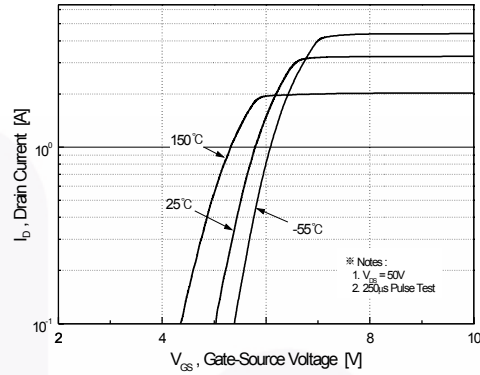
#### Notes:

1. Repetitive Rating : Pulse width limited by maximum junction temperature
2.  $L = 120\text{mH}, I_{AS} = 1.6\text{A}, V_{DD} = 50\text{V}, R_G = 25\ \Omega$ , Starting  $T_J = 25^\circ\text{C}$
3.  $I_{SD} \leq 2.0\text{A}, di/dt \leq 300\text{A}/\mu\text{s}, V_{DD} \leq BV_{DSS}$ , Starting  $T_J = 25^\circ\text{C}$
4. Essentially independent of operating temperature

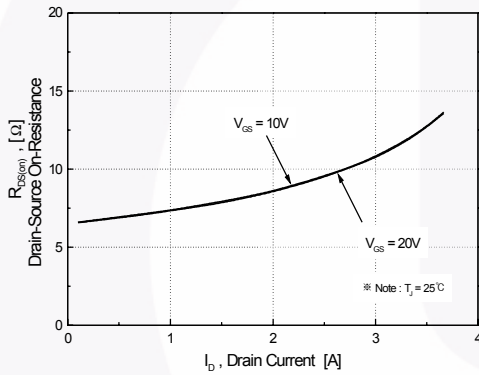
## Typical Characteristics



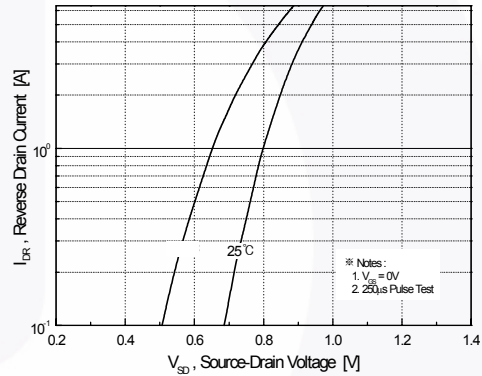
**Figure 1. On-Region Characteristics**



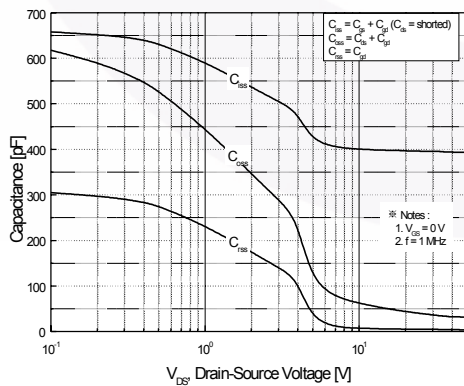
**Figure 2. Transfer Characteristics**



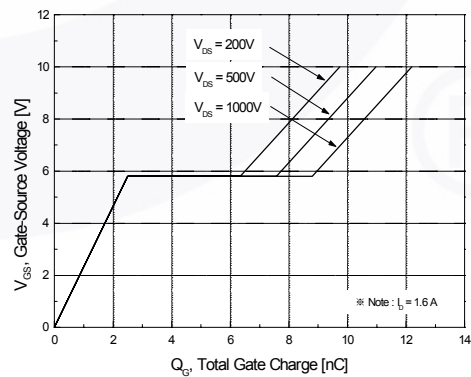
**Figure 3. On-Resistance Variation vs. Drain Current and Gate Voltage**



**Figure 4. Body Diode Forward Voltage Variation vs. Source Current and Temperature**



**Figure 5. Capacitance Characteristics**



**Figure 6. Gate Charge Characteristics**

Typical Characteristics (Continued)

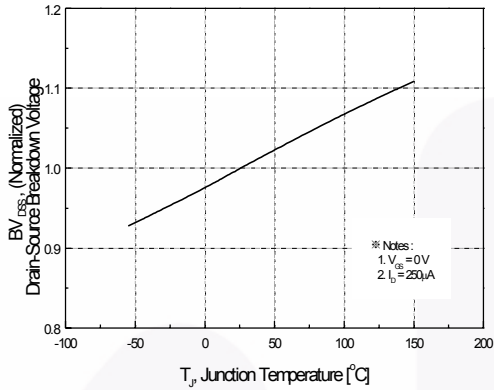


Figure 7. Breakdown Voltage Variation vs. Temperature

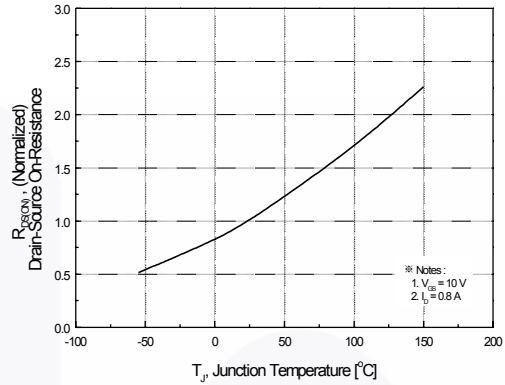


Figure 8. On-Resistance Variation vs. Temperature

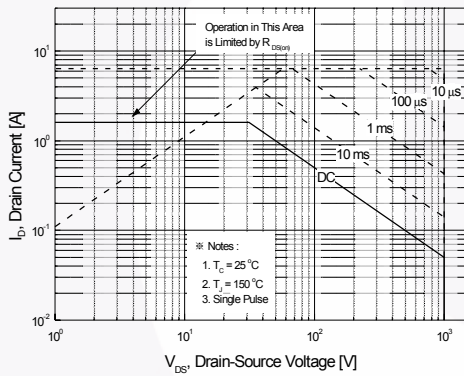


Figure 9. Maximum Safe Operating Area

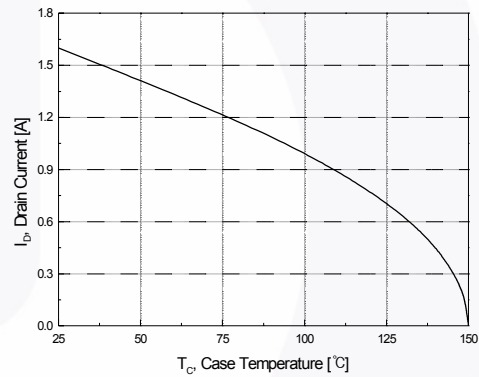


Figure 10. Maximum Drain Current vs. Case Temperature

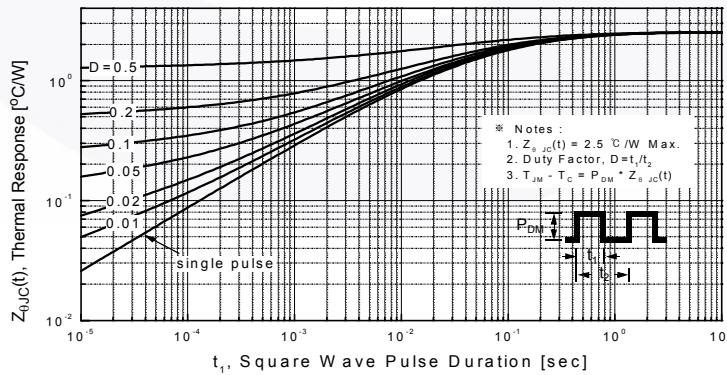
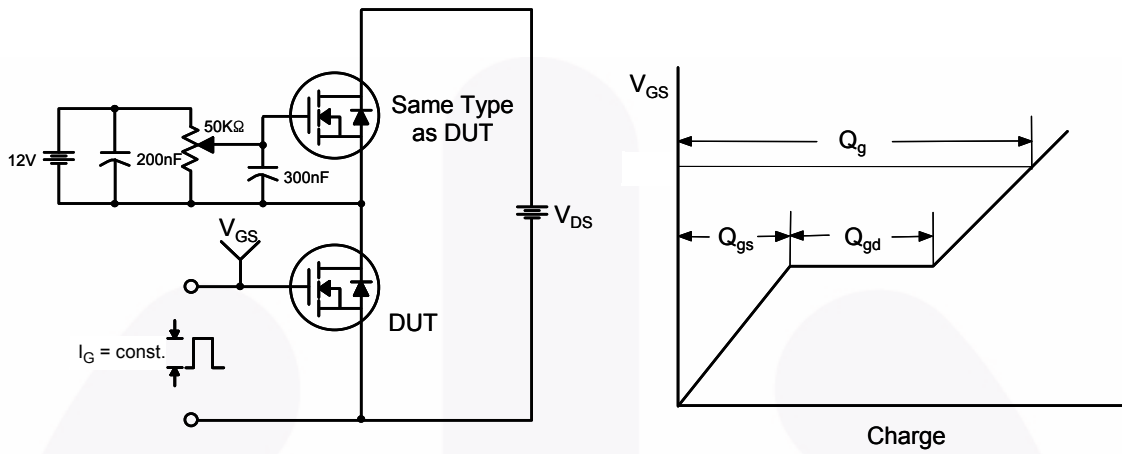
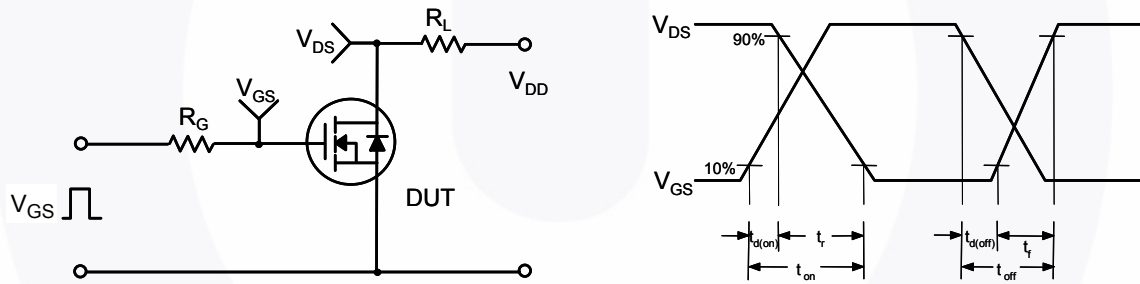


Figure 11. Transient Thermal Response Curve

**Figure 12. Gate Charge Test Circuit & Waveform**



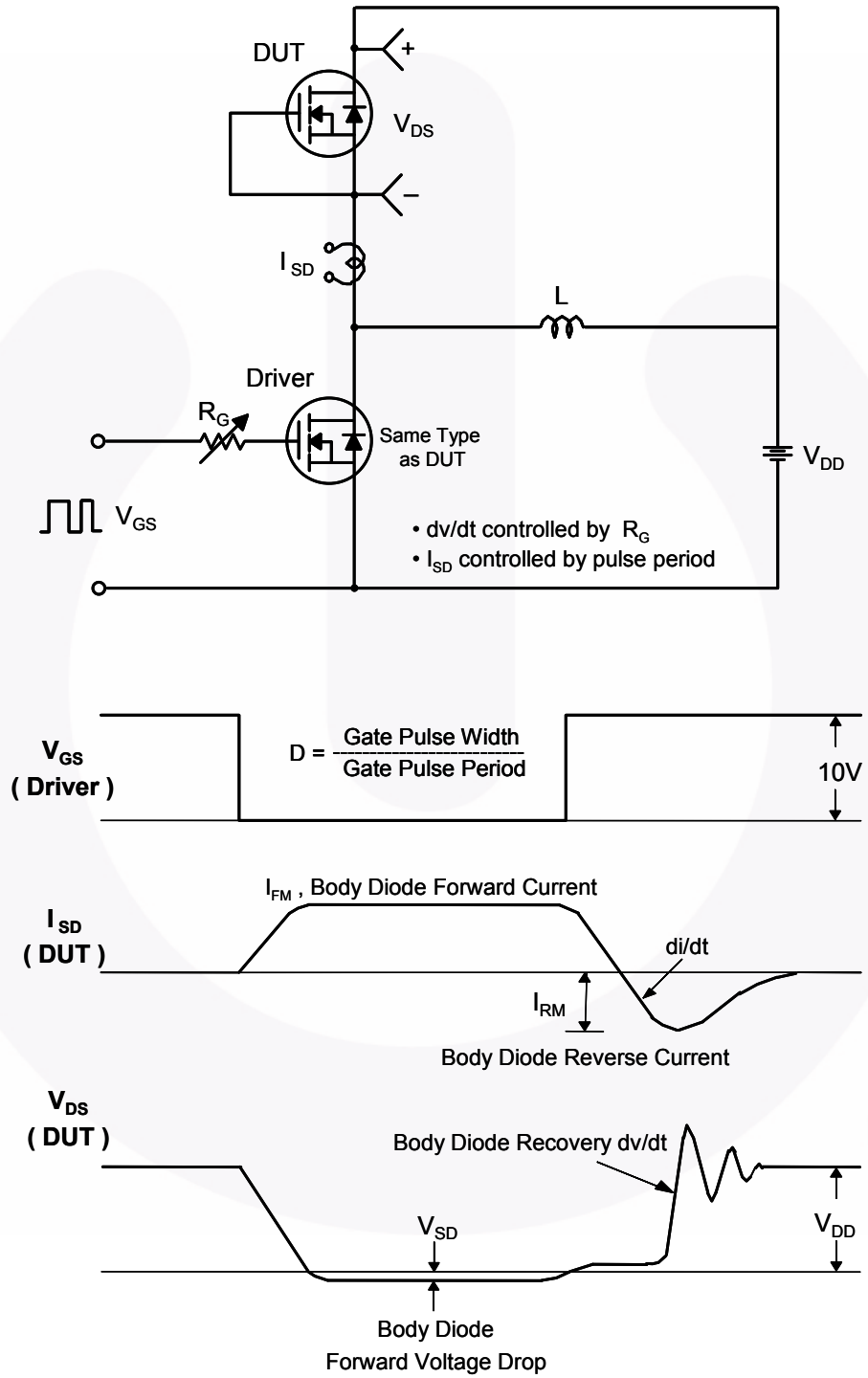
**Figure 13. Resistive Switching Test Circuit & Waveforms**



**Figure 14. Unclamped Inductive Switching Test Circuit & Waveforms**

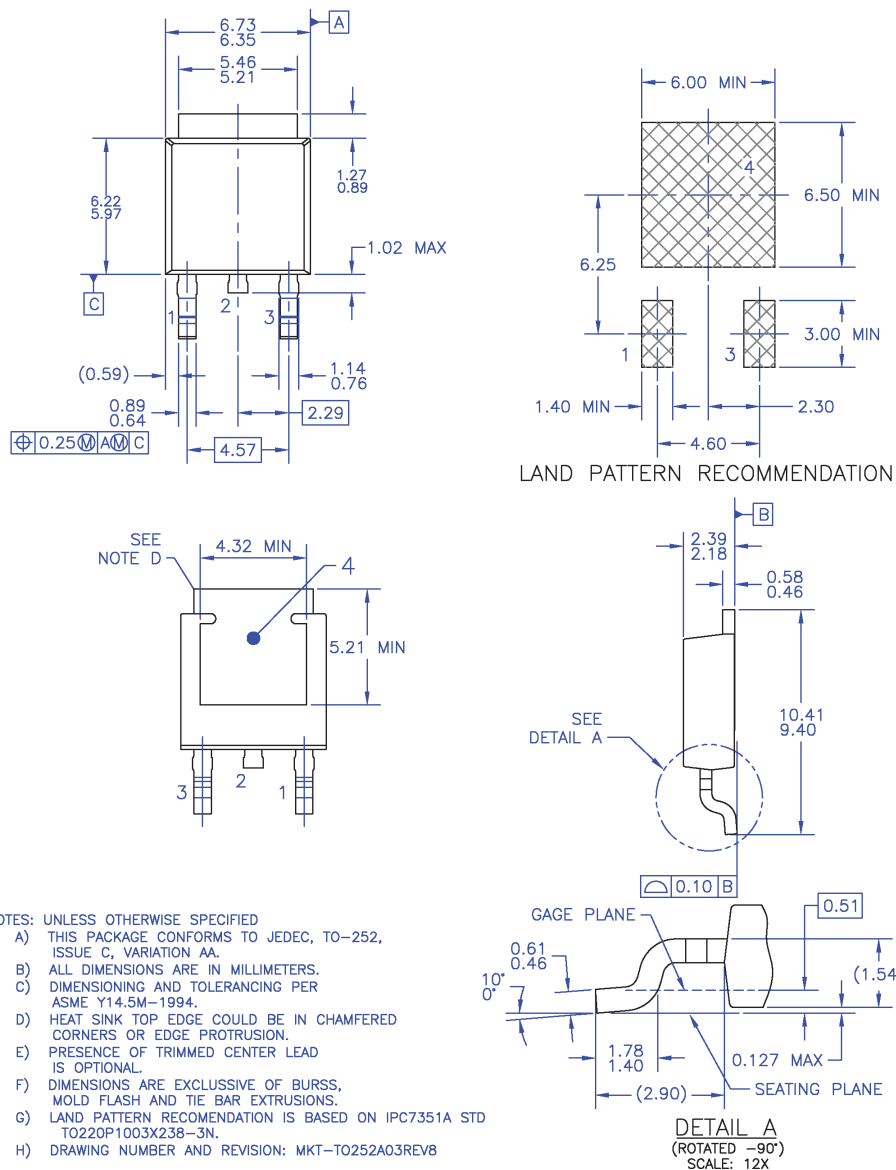


Figure 15. Peak Diode Recovery dv/dt Test Circuit & Waveforms



## Mechanical Dimensions

### TO-252 3L (DPAK)



**Figure 16. TO252 (D-PAK), Molded, 3 Lead, Option AA&AB**

Package drawings are provided as a service to customers considering Fairchild components. Drawings may change in any manner without notice. Please note the revision and/or date on the drawing and contact a Fairchild Semiconductor representative to verify or obtain the most recent revision. Package specifications do not expand the terms of Fairchild's worldwide terms and conditions, specifically the warranty therein, which covers Fairchild products.

Always visit Fairchild Semiconductor's online packaging area for the most recent package drawings:

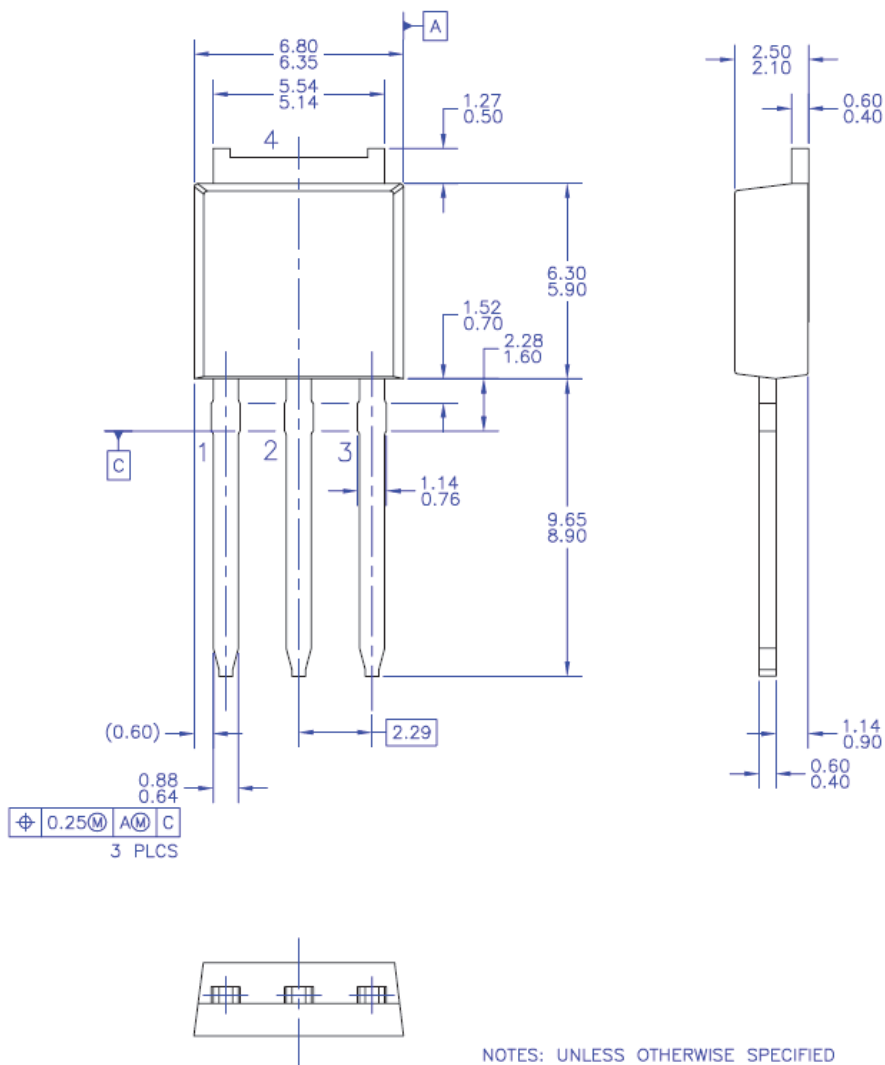
[http://www.fairchildsemi.com/package/packageDetails.html?id=PN\\_TT252-003](http://www.fairchildsemi.com/package/packageDetails.html?id=PN_TT252-003)

Dimension in Millimeters



## Mechanical Dimensions

### TO-251 3L (IPAK)



NOTES: UNLESS OTHERWISE SPECIFIED

- A) ALL DIMENSIONS ARE IN MILLIMETERS.
- B) THIS PACKAGE CONFORMS TO JEDEC, TO-251, ISSUE C, VARIATION AA, DATED SEP 1988.
- C) DIMENSIONING AND TOLERANCING PER ASME Y14.5M-1994.

**Figure 17. TO-251 (I-PAK) Molded, 3 Lead Option AA**

Package drawings are provided as a service to customers considering Fairchild components. Drawings may change in any manner without notice. Please note the revision and/or date on the drawing and contact a Fairchild Semiconductor representative to verify or obtain the most recent revision. Package specifications do not expand the terms of Fairchild's worldwide terms and conditions, specifically the warranty therein, which covers Fairchild products.

Always visit Fairchild Semiconductor's online packaging area for the most recent package drawings:

[http://www.fairchildsemi.com/package/packageDetails.html?id=PN\\_TT251-003](http://www.fairchildsemi.com/package/packageDetails.html?id=PN_TT251-003)

Dimension in Millimeters



**TRADEMARKS**

The following includes registered and unregistered trademarks and service marks, owned by Fairchild Semiconductor and/or its global subsidiaries, and is not intended to be an exhaustive list of all such trademarks.

- |                          |   |                           |
|--------------------------|---|---------------------------|
| AccuPower™               | F-PFS™  | Sync-Lock™                |
| AX-CAP®*                 | FRFET®  | <b>S</b> SYSTEM GENERAL®* |
| BitSiC™                  | Global Power Resource <sup>SM</sup>             | TinyBoost®                |
| Build it Now™            | GreenBridge™                                    | TinyBuck®                 |
| CorePLUS™                | Green FPS™                                      | TinyCalc™                 |
| CorePOWER™               | Green FPS™ e-Series™                            | TinyLogic®                |
| CROSSVOLT™               | Gmax™   | TINYOPTO™                 |
| CTL™                     | GTO™  | TinyPower™                |
| Current Transfer Logic™  | IntelliMAX™                                     | TinyPWM™                  |
| DEUXPEED®                | ISOPLANAR™                                      | TinyWire™                 |
| Dual Cool™               | Marking Small Speakers Sound Louder and Better™ | TranSiC™                  |
| EcoSPARK®                | MegaBuck™                                       | TriFault Detect™          |
| EfficientMax™            | MICROCOUPLER™                                   | TRUECURRENT®*             |
| ESBC™                    | MicroFET™                                       | μSerDes™                  |
| <b>F</b> ®               | MicroPak™                                       | <b>u</b> SerDes™          |
| Fairchild®               | MicroPak2™                                      | UHC®                      |
| Fairchild Semiconductor® | MillerDrive™                                    | Ultra FRFET™              |
| FACT Quiet Series™       | MotionMax™                                      | UniFET™                   |
| FACT®                    | mWSaver®  | VCX™                      |
| FAST®                    | OptoHiT™  | VisualMax™                |
| FastvCore™               | OPTOLOGIC®                                      | VoltagePlus™              |
| FETBench™                | OPTOPLANAR®                                     | XS™                       |
| FPS™                     |   |                           |
|                          | PowerTrench®                                    |                           |
|                          | PowerXS™  |                           |
|                          | Programmable Active Droop™                      |                           |
|                          | QFET®   |                           |
|                          | QS™   |                           |
|                          | Quiet Series™                                   |                           |
|                          | RapidConfigure™                                 |                           |
|                          | Saving our world, 1mW/W/kW at a time™           |                           |
|                          | SignalWise™                                     |                           |
|                          | SmartMax™                                       |                           |
|                          | SMART START™                                    |                           |
|                          | Solutions for Your Success™                     |                           |
|                          | SPM®  |                           |
|                          | STEALTH™  |                           |
|                          | SuperFET®                                       |                           |
|                          | SuperSOT™-3                                     |                           |
|                          | SuperSOT™-6                                     |                           |
|                          | SuperSOT™-8                                     |                           |
|                          | SupreMOS®                                       |                           |
|                          | SyncFET™  |                           |

\*Trademarks of System General Corporation, used under license by Fairchild Semiconductor.

**DISCLAIMER**

FAIRCHILD SEMICONDUCTOR RESERVES THE RIGHT TO MAKE CHANGES WITHOUT FURTHER NOTICE TO ANY PRODUCTS HEREIN TO IMPROVE RELIABILITY, FUNCTION, OR DESIGN. FAIRCHILD DOES NOT ASSUME ANY LIABILITY ARISING OUT OF THE APPLICATION OR USE OF ANY PRODUCT OR CIRCUIT DESCRIBED HEREIN; NEITHER DOES IT CONVEY ANY LICENSE UNDER ITS PATENT RIGHTS, NOR THE RIGHTS OF OTHERS. THESE SPECIFICATIONS DO NOT EXPAND THE TERMS OF FAIRCHILD'S WORLDWIDE TERMS AND CONDITIONS, SPECIFICALLY THE WARRANTY THEREIN, WHICH COVERS THESE PRODUCTS.

**LIFE SUPPORT POLICY**

FAIRCHILD'S PRODUCTS ARE NOT AUTHORIZED FOR USE AS CRITICAL COMPONENTS IN LIFE SUPPORT DEVICES OR SYSTEMS WITHOUT THE EXPRESS WRITTEN APPROVAL OF FAIRCHILD SEMICONDUCTOR CORPORATION.

As used here in:

- Life support devices or systems are devices or systems which, (a) are intended for surgical implant into the body or (b) support or sustain life, and (c) whose failure to perform when properly used in accordance with instructions for use provided in the labeling, can be reasonably expected to result in a significant injury of the user.
- A critical component in any component of a life support, device, or system whose failure to perform can be reasonably expected to cause the failure of the life support device or system, or to affect its safety or effectiveness.

**ANTI-COUNTERFEITING POLICY**

Fairchild Semiconductor Corporation's Anti-Counterfeiting Policy. Fairchild's Anti-Counterfeiting Policy is also stated on our external website, [www.Fairchildsemi.com](http://www.Fairchildsemi.com), under Sales Support. Counterfeiting of semiconductor parts is a growing problem in the industry. All manufactures of semiconductor products are experiencing counterfeiting of their parts. Customers who inadvertently purchase counterfeit parts experience many problems such as loss of brand reputation, substandard performance, failed application, and increased cost of production and manufacturing delays. Fairchild is taking strong measures to protect ourselves and our customers from the proliferation of counterfeit parts. Fairchild strongly encourages customers to purchase Fairchild parts either directly from Fairchild or from Authorized Fairchild Distributors who are listed by country on our web page cited above. Products customers buy either from Fairchild directly or from Authorized Fairchild Distributors are genuine parts, have full traceability, meet Fairchild's quality standards for handling and storage and provide access to Fairchild's full range of up-to-date technical and product information. Fairchild and our Authorized Distributors will stand behind all warranties and will appropriately address and warranty issues that may arise. Fairchild will not provide any warranty coverage or other assistance for parts bought from Unauthorized Sources. Fairchild is committed to combat this global problem and encourage our customers to do their part in stopping this practice by buying direct or from authorized distributors.

**PRODUCT STATUS DEFINITIONS**

**Definition of Terms**

Datasheet Identification	Product Status	Definition
Advance Information	Formative / In Design	Datasheet contains the design specifications for product development. Specifications may change in any manner without notice.
Preliminary	First Production	Datasheet contains preliminary data; supplementary data will be published at a later date. Fairchild Semiconductor reserves the right to make changes at any time without notice to improve design.
No Identification Needed	Full Production	Datasheet contains final specifications. Fairchild Semiconductor reserves the right to make changes at any time without notice to improve the design.
Obsolete	Not In Production	Datasheet contains specifications on a product that is discontinued by Fairchild Semiconductor. The datasheet is for reference information only.

Rev. I66

ON Semiconductor and  are trademarks of Semiconductor Components Industries, LLC dba ON Semiconductor or its subsidiaries in the United States and/or other countries. ON Semiconductor owns the rights to a number of patents, trademarks, copyrights, trade secrets, and other intellectual property. A listing of ON Semiconductor's product/patent coverage may be accessed at [www.onsemi.com/site/pdf/Patent-Marking.pdf](http://www.onsemi.com/site/pdf/Patent-Marking.pdf). ON Semiconductor reserves the right to make changes without further notice to any products herein. ON Semiconductor makes no warranty, representation or guarantee regarding the suitability of its products for any particular purpose, nor does ON Semiconductor assume any liability arising out of the application or use of any product or circuit, and specifically disclaims any and all liability, including without limitation special, consequential or incidental damages. Buyer is responsible for its products and applications using ON Semiconductor products, including compliance with all laws, regulations and safety requirements or standards, regardless of any support or applications information provided by ON Semiconductor. "Typical" parameters which may be provided in ON Semiconductor data sheets and/or specifications can and do vary in different applications and actual performance may vary over time. All operating parameters, including "Typicals" must be validated for each customer application by customer's technical experts. ON Semiconductor does not convey any license under its patent rights nor the rights of others. ON Semiconductor products are not designed, intended, or authorized for use as a critical component in life support systems or any FDA Class 3 medical devices or medical devices with a same or similar classification in a foreign jurisdiction or any devices intended for implantation in the human body. Should Buyer purchase or use ON Semiconductor products for any such unintended or unauthorized application, Buyer shall indemnify and hold ON Semiconductor and its officers, employees, subsidiaries, affiliates, and distributors harmless against all claims, costs, damages, and expenses, and reasonable attorney fees arising out of, directly or indirectly, any claim of personal injury or death associated with such unintended or unauthorized use, even if such claim alleges that ON Semiconductor was negligent regarding the design or manufacture of the part. ON Semiconductor is an Equal Opportunity/Affirmative Action Employer. This literature is subject to all applicable copyright laws and is not for resale in any manner.

## PUBLICATION ORDERING INFORMATION

### LITERATURE FULFILLMENT:

Literature Distribution Center for ON Semiconductor  
19521 E. 32nd Pkwy, Aurora, Colorado 80011 USA  
**Phone:** 303-675-2175 or 800-344-3860 Toll Free USA/Canada  
**Fax:** 303-675-2176 or 800-344-3867 Toll Free USA/Canada  
**Email:** [orderlit@onsemi.com](mailto:orderlit@onsemi.com)

**N. American Technical Support:** 800-282-9855 Toll Free  
USA/Canada  
**Europe, Middle East and Africa Technical Support:**  
Phone: 421 33 790 2910  
**Japan Customer Focus Center**  
Phone: 81-3-5817-1050

**ON Semiconductor Website:** [www.onsemi.com](http://www.onsemi.com)  
**Order Literature:** <http://www.onsemi.com/orderlit>  
For additional information, please contact your local  
Sales Representative