



Is Now Part of



**ON Semiconductor®**

To learn more about ON Semiconductor, please visit our website at  
[www.onsemi.com](http://www.onsemi.com)

ON Semiconductor and the ON Semiconductor logo are trademarks of Semiconductor Components Industries, LLC dba ON Semiconductor or its subsidiaries in the United States and/or other countries. ON Semiconductor owns the rights to a number of patents, trademarks, copyrights, trade secrets, and other intellectual property. A listing of ON Semiconductor's product/patent coverage may be accessed at [www.onsemi.com/site/pdf/Patent-Marking.pdf](http://www.onsemi.com/site/pdf/Patent-Marking.pdf). ON Semiconductor reserves the right to make changes without further notice to any products herein. ON Semiconductor makes no warranty, representation or guarantee regarding the suitability of its products for any particular purpose, nor does ON Semiconductor assume any liability arising out of the application or use of any product or circuit, and specifically disclaims any and all liability, including without limitation special, consequential or incidental damages. Buyer is responsible for its products and applications using ON Semiconductor products, including compliance with all laws, regulations and safety requirements or standards, regardless of any support or applications information provided by ON Semiconductor. "Typical" parameters which may be provided in ON Semiconductor data sheets and/or specifications can and do vary in different applications and actual performance may vary over time. All operating parameters, including "Typicals" must be validated for each customer application by customer's technical experts. ON Semiconductor does not convey any license under its patent rights nor the rights of others. ON Semiconductor products are not designed, intended, or authorized for use as a critical component in life support systems or any FDA Class 3 medical devices or medical devices with a same or similar classification in a foreign jurisdiction or any devices intended for implantation in the human body. Should Buyer purchase or use ON Semiconductor products for any such unintended or unauthorized application, Buyer shall indemnify and hold ON Semiconductor and its officers, employees, subsidiaries, affiliates, and distributors harmless against all claims, costs, damages, and expenses, and reasonable attorney fees arising out of, directly or indirectly, any claim of personal injury or death associated with such unintended or unauthorized use, even if such claim alleges that ON Semiconductor was negligent regarding the design or manufacture of the part. ON Semiconductor is an Equal Opportunity/Affirmative Action Employer. This literature is subject to all applicable copyright laws and is not for resale in any manner.

**24A, 600V, UFS Series N-Channel IGBT with Anti-Parallel Hyperfast Diode**

The HGTG12N60C3D is a MOS gated high voltage switching device combining the best features of MOSFETs and bipolar transistors. The device has the high input impedance of a MOSFET and the low on-state conduction loss of a bipolar transistor. The much lower on-state voltage drop varies only moderately between 25°C and 150°C. The IGBT used is the development type TA49123. The diode used in anti parallel with the IGBT is the development type TA49061.

The IGBT is ideal for many high voltage switching applications operating at moderate frequencies where low conduction losses are essential.

Formerly Developmental Type TA49117.

**Ordering Information**

| PART NUMBER  | PACKAGE | BRAND     |
|--------------|---------|-----------|
| HGTG12N60C3D | TO-247  | G12N60C3D |

NOTE: When ordering, use the entire part number.

**Symbol**

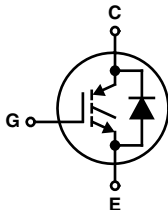

**Features**

- 24A, 600V at  $T_C = 25^\circ\text{C}$
- Typical Fall Time . . . . . 210ns at  $T_J = 150^\circ\text{C}$
- Short Circuit Rating
- Low Conduction Loss
- Hyperfast Anti-Parallel Diode

**Packaging**

JEDEC STYLE TO-247

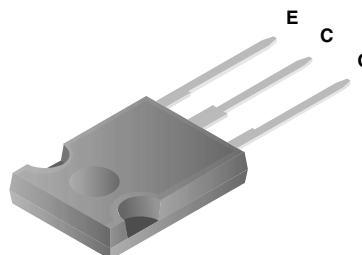

# HGTG12N60C3D

## Absolute Maximum Ratings $T_C = 25^\circ\text{C}$ , Unless Otherwise Specified

|  | HGTG12N60C3D | UNITS               |
|--|--------------|---------------------|
| Collector to Emitter Voltage                                   | 600          | V                   |
| Collector Current Continuous                                   |              |                     |
| At $T_C = 25^\circ\text{C}$                                    | 24           | A                   |
| At $T_C = 110^\circ\text{C}$                                   | 12           | A                   |
| Average Diode Forward Current at $110^\circ\text{C}$           | 15           | A                   |
| Collector Current Pulsed (Note 1)                              | 96           | A                   |
| Gate to Emitter Voltage Continuous                             | $\pm 20$     | V                   |
| Gate to Emitter Voltage Pulsed                                 | $\pm 30$     | V                   |
| Switching Safe Operating Area at $T_J = 150^\circ\text{C}$     | 24A at 600V  |                     |
| Power Dissipation Total at $T_C = 25^\circ\text{C}$            | 104          | W                   |
| Power Dissipation Derating $T_C > 25^\circ\text{C}$            | 0.83         | W/ $^\circ\text{C}$ |
| Operating and Storage Junction Temperature Range               | -40 to 150   | $^\circ\text{C}$    |
| Maximum Lead Temperature for Soldering                         | 260          | $^\circ\text{C}$    |
| Short Circuit Withstand Time (Note 2) at $V_{GE} = 15\text{V}$ | 4            | $\mu\text{s}$       |
| Short Circuit Withstand Time (Note 2) at $V_{GE} = 10\text{V}$ | 13           | $\mu\text{s}$       |

CAUTION: Stresses above those listed in "Absolute Maximum Ratings" may cause permanent damage to the device. This is a stress only rating and operation of the device at these or any other conditions above those indicated in the operational sections of this specification is not implied.

### NOTES:

1. Repetitive Rating: Pulse width limited by maximum junction temperature.
2.  $V_{CE(PK)} = 360\text{V}$ ,  $T_J = 125^\circ\text{C}$ ,  $R_G = 25\Omega$ .

## Electrical Specifications $T_C = 25^\circ\text{C}$ , Unless Otherwise Specified

| PARAMETER                               | SYMBOL        | TEST CONDITIONS  | MIN                        | TYP | MAX       | UNITS         |    |
|---|---------------|--|----------------------------|-----|-----------|---------------|----|
| Collector to Emitter Breakdown Voltage  | $BV_{CES}$    | $I_C = 250\mu\text{A}$ , $V_{GE} = 0\text{V}$  | 600                        | -   | -         | V             |    |
| Emitter to Collector Breakdown Voltage  | $BV_{ECS}$    | $I_C = 10\text{mA}$ , $V_{GE} = 0\text{V}$   | 15                         | 25  | -         | V             |    |
| Collector to Emitter Leakage Current    | $I_{CES}$     | $V_{CE} = BV_{CES}$ , $T_C = 25^\circ\text{C}$   | -                          | -   | 250       | $\mu\text{A}$ |    |
|   |               | $V_{CE} = BV_{CES}$ , $T_C = 150^\circ\text{C}$  | -                          | -   | 2.0       | mA            |    |
| Collector to Emitter Saturation Voltage | $V_{CE(SAT)}$ | $I_C = I_{C110}$ ,<br>$V_{GE} = 15\text{V}$  | $T_C = 25^\circ\text{C}$   | -   | 1.65      | 2.0           | V  |
|   |               |  | $T_C = 150^\circ\text{C}$  | -   | 1.85      | 2.2           | V  |
|   |               | $I_C = 15\text{A}$ ,<br>$V_{GE} = 15\text{V}$  | $T_C = 25^\circ\text{C}$   | -   | 1.80      | 2.2           | V  |
|   |               |  | $T_C = 150^\circ\text{C}$  | -   | 2.0       | 2.4           | V  |
| Gate to Emitter Threshold Voltage       | $V_{GE(TH)}$  | $I_C = 250\mu\text{A}$ ,<br>$V_{CE} = V_{GE}$  | 3.0                        | 5.0 | 6.0       | V             |    |
| Gate to Emitter Leakage Current         | $I_{GES}$     | $V_{GE} = \pm 20\text{V}$  | -                          | -   | $\pm 100$ | nA            |    |
| Switching SOA                           | SSOA          | $T_J = 150^\circ\text{C}$ ,<br>$V_{GE} = 15\text{V}$ ,<br>$R_G = 25\Omega$ ,<br>$L = 100\mu\text{H}$   | $V_{CE(PK)} = 480\text{V}$ | 80  | -         | -             | A  |
|   |               |  | $V_{CE(PK)} = 600\text{V}$ | 24  | -         | -             | A  |
| Gate to Emitter Plateau Voltage         | $V_{GEP}$     | $I_C = I_{C110}$ , $V_{CE} = 0.5 BV_{CES}$   | -                          | 7.6 | -         | V             |    |
| On-State Gate Charge                    | $Q_{G(ON)}$   | $I_C = I_{C110}$ ,<br>$V_{CE} = 0.5 BV_{CES}$  | $V_{GE} = 15\text{V}$      | -   | 48        | 55            | nC |
|   |               |  | $V_{GE} = 20\text{V}$      | -   | 62        | 71            | nC |
| Current Turn-On Delay Time              | $t_{d(ON)I}$  | $T_J = 150^\circ\text{C}$ ,<br>$I_{CE} = I_{C110}$ ,<br>$V_{CE(PK)} = 0.8 BV_{CES}$ ,<br>$V_{GE} = 15\text{V}$ ,<br>$R_G = 25\Omega$ ,<br>$L = 100\mu\text{H}$ | -                          | 14  | -         | ns            |    |
| Current Rise Time                       | $t_{rI}$      |  | -                          | 16  | -         | ns            |    |
| Current Turn-Off Delay Time             | $t_{d(OFF)I}$ |  | -                          | 270 | 400       | ns            |    |
| Current Fall Time                       | $t_{fI}$      |  | -                          | 210 | 275       | ns            |    |
| Turn-On Energy                          | $E_{ON}$      |  | -                          | 380 | -         | $\mu\text{J}$ |    |
| Turn-Off Energy (Note 3)                | $E_{OFF}$     |  | -                          | 900 | -         | $\mu\text{J}$ |    |
| Diode Forward Voltage                   | $V_{EC}$      | $I_{EC} = 12\text{A}$  | -                          | 1.7 | 2.0       | V             |    |

# HGTG12N60C3D

## Electrical Specifications $T_C = 25^\circ\text{C}$ , Unless Otherwise Specified (Continued)

| PARAMETER                   | SYMBOL          | TEST CONDITIONS  | MIN | TYP | MAX | UNITS                     |
|-----------------------------|-----------------|--|-----|-----|-----|---------------------------|
| Diode Reverse Recovery Time | $t_{rr}$        | $I_{EC} = 12\text{A}, dI_{EC}/dt = 100\text{A}/\mu\text{s}$  | -   | 34  | 42  | ns                        |
|                             |                 | $I_{EC} = 1.0\text{A}, dI_{EC}/dt = 100\text{A}/\mu\text{s}$ | -   | 30  | 37  | ns                        |
| Thermal Resistance          | $R_{\theta JC}$ | IGBT   | -   | -   | 1.2 | $^\circ\text{C}/\text{W}$ |
|                             |                 | Diode  | -   | -   | 1.5 | $^\circ\text{C}/\text{W}$ |

NOTE:

- Turn-Off Energy Loss ( $E_{OFF}$ ) is defined as the integral of the instantaneous power loss starting at the trailing edge of the input pulse, and ending at the point where the collector current equals zero ( $I_{CE} = 0\text{A}$ ). The HGTG12N60C3D was tested per JEDEC Standard No. 24-1 Method for Measurement of Power Device Turn-Off Switching Loss. This test method produces the true total Turn-Off Energy Loss. Turn-On losses include diode losses.

## Typical Performance Curves

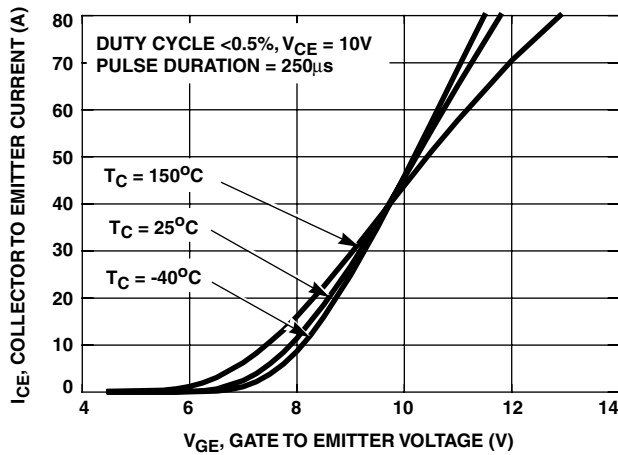

FIGURE 1. TRANSFER CHARACTERISTICS

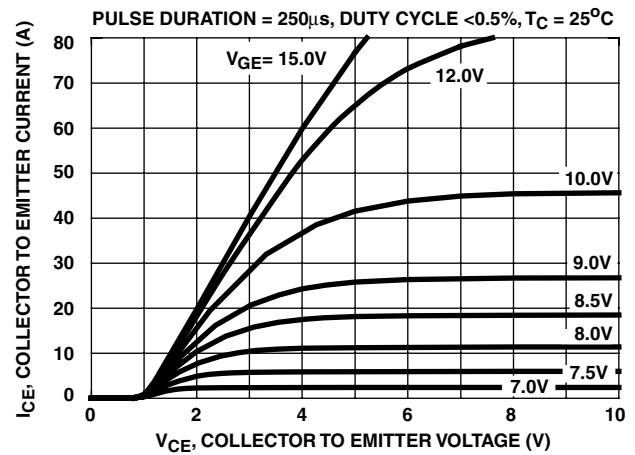

FIGURE 2. SATURATION CHARACTERISTICS

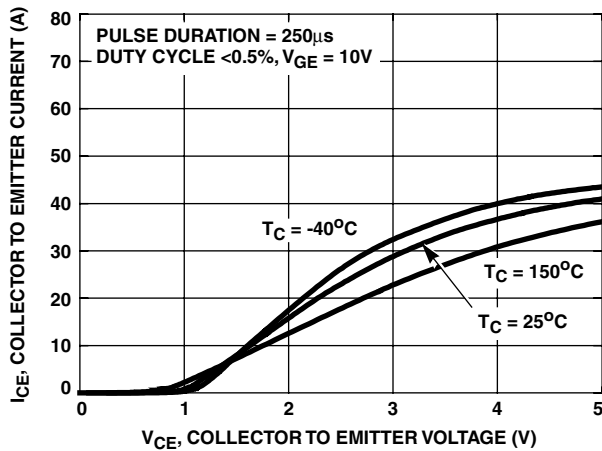

FIGURE 3. COLLECTOR TO EMITTER ON-STATE VOLTAGE

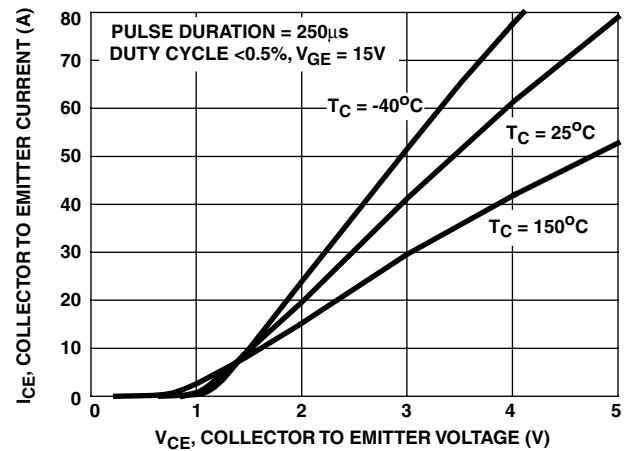

FIGURE 4. COLLECTOR TO EMITTER ON-STATE VOLTAGE

Typical Performance Curves (Continued)

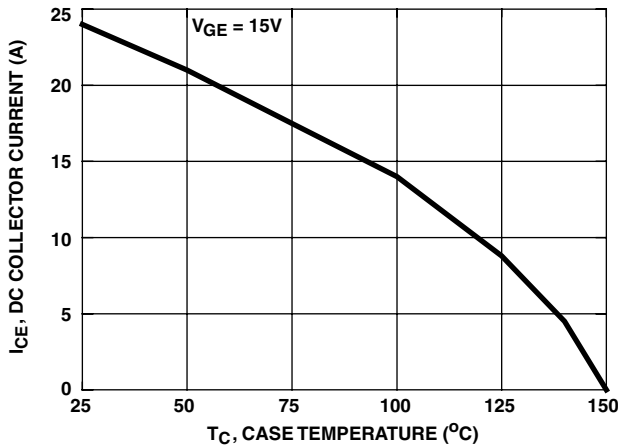

FIGURE 5. MAXIMUM DC COLLECTOR CURRENT vs CASE TEMPERATURE

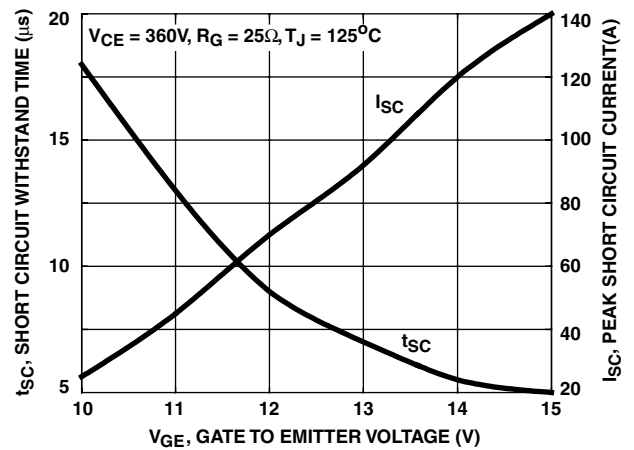

FIGURE 6. SHORT CIRCUIT WITHSTAND TIME

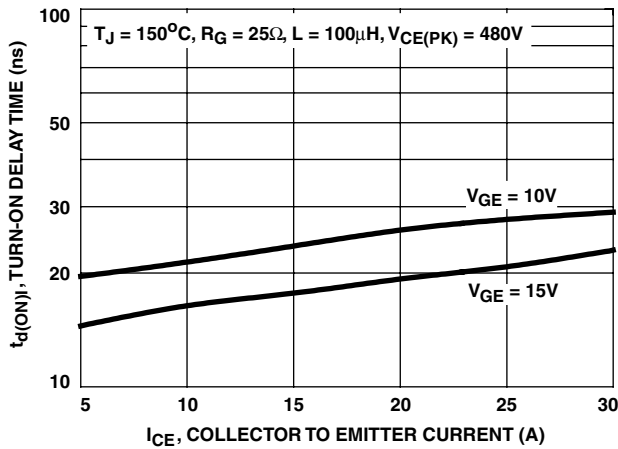

FIGURE 7. TURN-ON DELAY TIME vs COLLECTOR TO EMITTER CURRENT

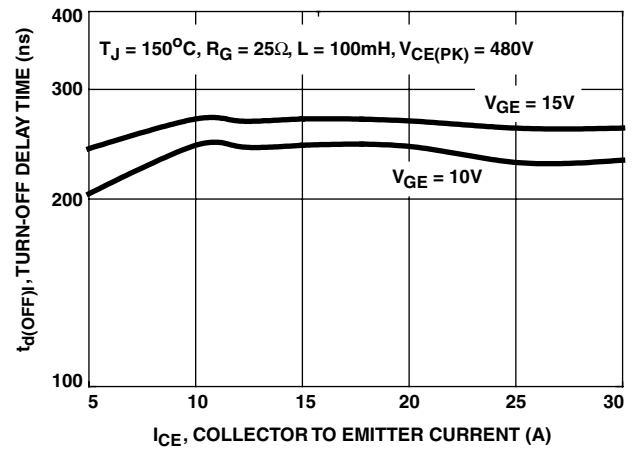

FIGURE 8. TURN-OFF DELAY TIME vs COLLECTOR TO EMITTER CURRENT

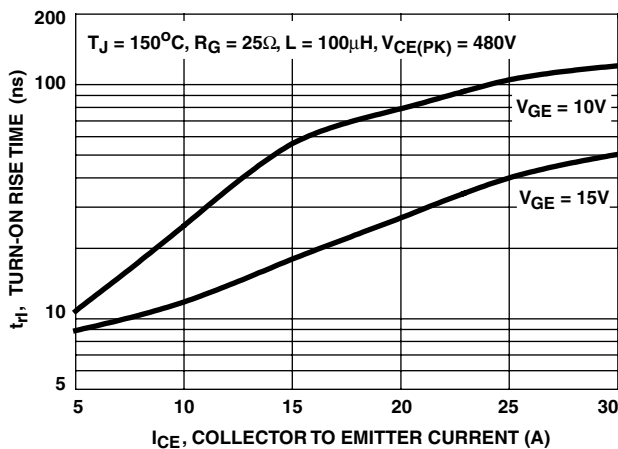

FIGURE 9. TURN-ON RISE TIME vs COLLECTOR TO EMITTER CURRENT

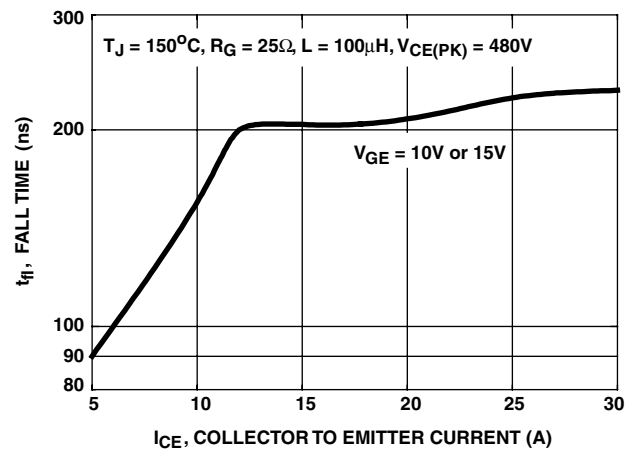

FIGURE 10. TURN-OFF FALL TIME vs COLLECTOR TO EMITTER CURRENT

Typical Performance Curves (Continued)

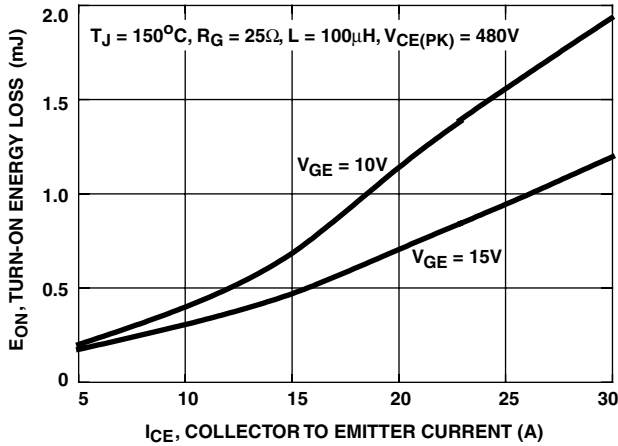

FIGURE 11. TURN-ON ENERGY LOSS vs COLLECTOR TO EMITTER CURRENT

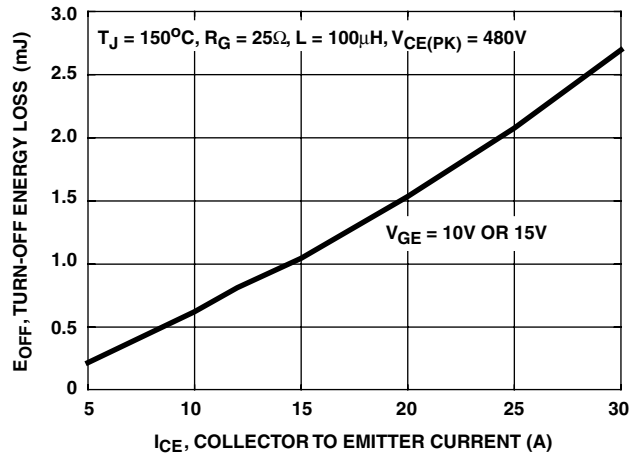

FIGURE 12. TURN-OFF ENERGY LOSS vs COLLECTOR TO EMITTER CURRENT

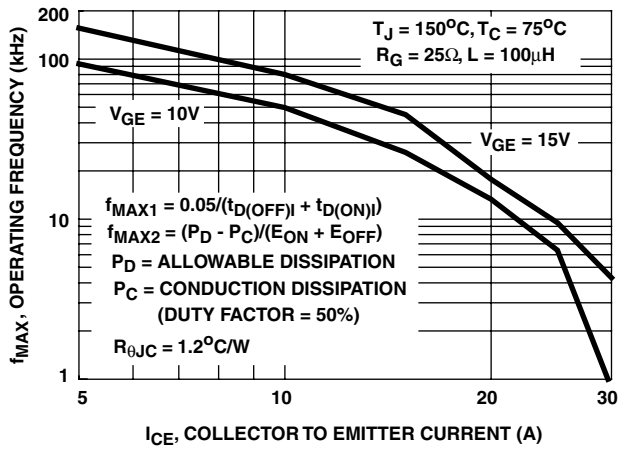

FIGURE 13. OPERATING FREQUENCY vs COLLECTOR TO EMITTER CURRENT

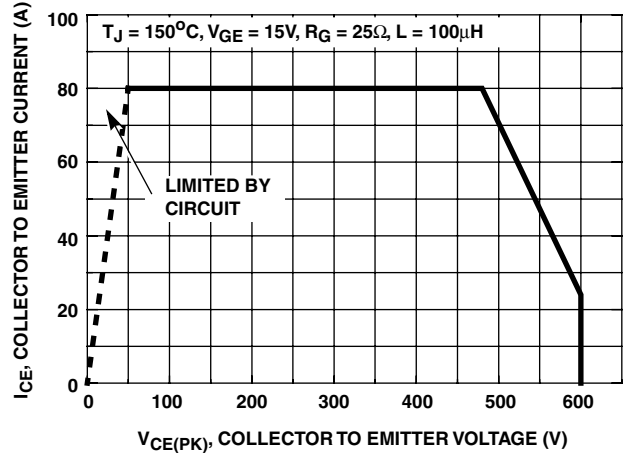

FIGURE 14. SWITCHING SAFE OPERATING AREA

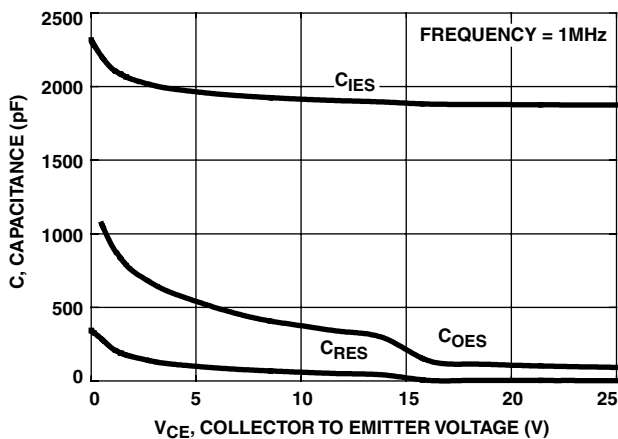

FIGURE 15. CAPACITANCE vs COLLECTOR TO EMITTER VOLTAGE

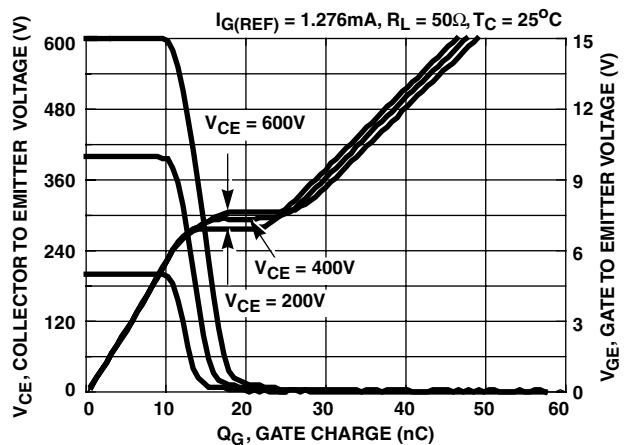

FIGURE 16. GATE CHARGE WAVEFORMS

Typical Performance Curves (Continued)

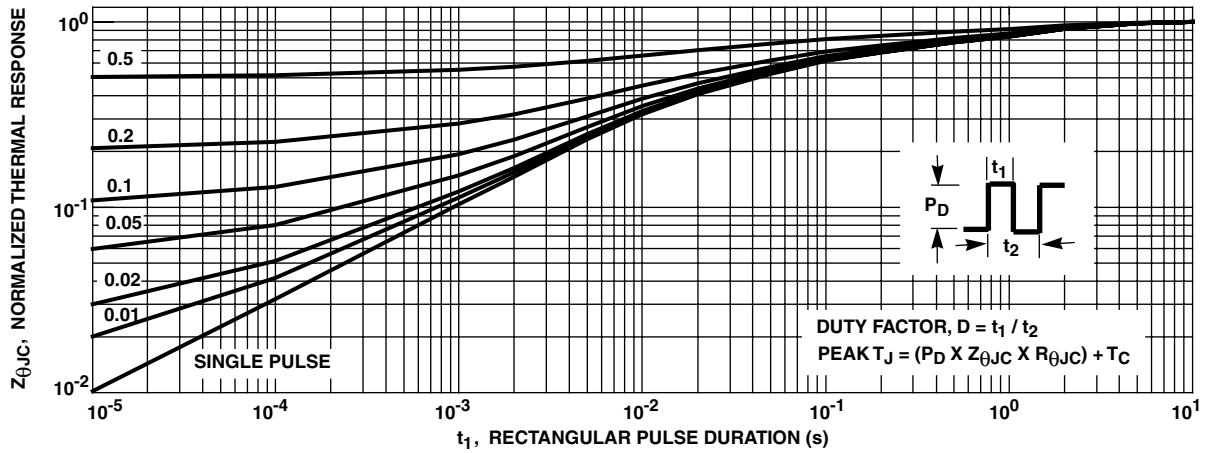

FIGURE 17. IGBT NORMALIZED TRANSIENT THERMAL IMPEDANCE, JUNCTION TO CASE

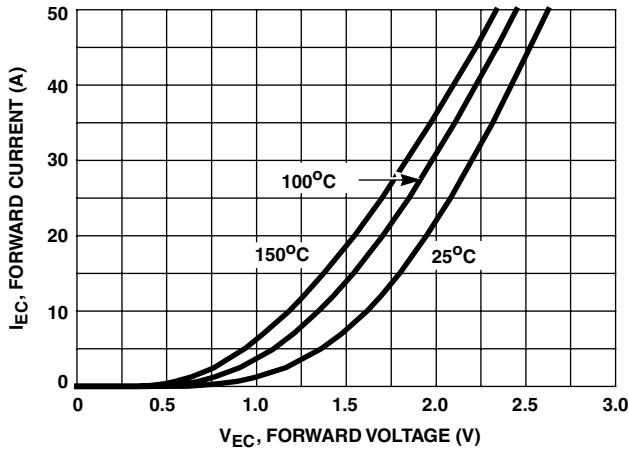

FIGURE 18. DIODE FORWARD CURRENT vs FORWARD VOLTAGE DROP

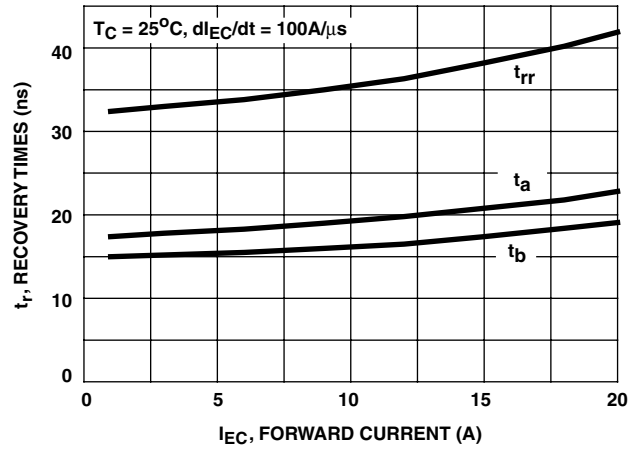

FIGURE 19. RECOVERY TIMES vs FORWARD CURRENT

Test Circuit and Waveform

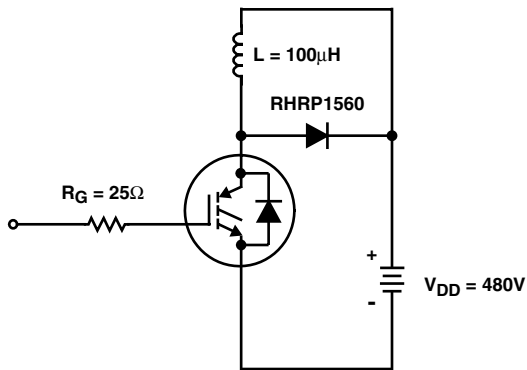

FIGURE 20. INDUCTIVE SWITCHING TEST CIRCUIT

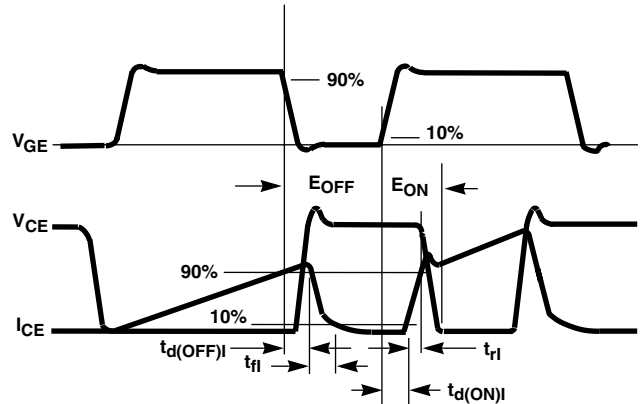

FIGURE 21. SWITCHING TEST WAVEFORMS

## Handling Precautions for IGBTs

Insulated Gate Bipolar Transistors are susceptible to gate-insulation damage by the electrostatic discharge of energy through the devices. When handling these devices, care should be exercised to assure that the static charge built in the handler's body capacitance is not discharged through the device. With proper handling and application procedures, however, IGBTs are currently being extensively used in production by numerous equipment manufacturers in military, industrial and consumer applications, with virtually no damage problems due to electrostatic discharge. IGBTs can be handled safely if the following basic precautions are taken:

1. Prior to assembly into a circuit, all leads should be kept shorted together either by the use of metal shorting springs or by the insertion into conductive material such as "ECCOSORB™ LD26" or equivalent.
2. When devices are removed by hand from their carriers, the hand being used should be grounded by any suitable means, for example, with a metallic wristband.
3. Tips of soldering irons should be grounded.
4. Devices should never be inserted into or removed from circuits with power on.
5. **Gate Voltage Rating** - Never exceed the gate-voltage rating of  $V_{GEM}$ . Exceeding the rated  $V_{GE}$  can result in permanent damage to the oxide layer in the gate region.
6. **Gate Termination** - The gates of these devices are essentially capacitors. Circuits that leave the gate open-circuited or floating should be avoided. These conditions can result in turn-on of the device due to voltage buildup on the input capacitor due to leakage currents or pickup.
7. **Gate Protection** - These devices do not have an internal monolithic Zener Diode from gate to emitter. If gate protection is required an external Zener is recommended.

## Operating Frequency Information

Operating frequency information for a typical device (Figure 13) is presented as a guide for estimating device performance for a specific application. Other typical frequency vs collector current ( $I_{CE}$ ) plots are possible using the information shown for a typical unit in Figures 4, 7, 8, 11 and 12. The operating frequency plot (Figure 13) of a typical device shows  $f_{MAX1}$  or  $f_{MAX2}$  whichever is smaller at each point. The information is based on measurements of a typical device and is bounded by the maximum rated junction temperature.

$f_{MAX1}$  is defined by  $f_{MAX1} = 0.05 / (t_{D(OFF)I} + t_{D(ON)I})$ . Deadtime (the denominator) has been arbitrarily held to 10% of the on-state time for a 50% duty factor. Other definitions are possible.  $t_{D(OFF)I}$  and  $t_{D(ON)I}$  are defined in Figure 21.

Device turn-off delay can establish an additional frequency limiting condition for an application other than  $T_{JM}$ .  $t_{D(OFF)I}$  is important when controlling output ripple under a lightly loaded condition.

$f_{MAX2}$  is defined by  $f_{MAX2} = (P_D - P_C) / (E_{OFF} + E_{ON})$ . The allowable dissipation ( $P_D$ ) is defined by  $P_D = (T_{JM} - T_C) / R_{\theta JC}$ . The sum of device switching and conduction losses must not exceed  $P_D$ . A 50% duty factor was used (Figure 13) and the conduction losses ( $P_C$ ) are approximated by  $P_C = (V_{CE} \times I_{CE}) / 2$ .

$E_{ON}$  and  $E_{OFF}$  are defined in the switching waveforms shown in Figure 21.  $E_{ON}$  is the integral of the instantaneous power loss ( $I_{CE} \times V_{CE}$ ) during turn-on and  $E_{OFF}$  is the integral of the instantaneous power loss during turn-off. All tail losses are included in the calculation for  $E_{OFF}$ ; i.e. the collector current equals zero ( $I_{CE} = 0$ ).



## TRADEMARKS

The following are registered and unregistered trademarks Fairchild Semiconductor owns or is authorized to use and is not intended to be an exhaustive list of all such trademarks.

|                                   |                                  |                                  |                              |                   |
|-----------------------------------|----------------------------------|----------------------------------|------------------------------|-------------------|
| ACE <sub>x</sub> <sup>TM</sup>    | FAST <sup>®</sup>                | OPTOLOGIC <sup>TM</sup>          | SMART START <sup>TM</sup>    | VCX <sup>TM</sup> |
| Bottomless <sup>TM</sup>          | FAST <sub>r</sub> <sup>TM</sup>  | OPTOPLANAR <sup>TM</sup>         | STAR*POWER <sup>TM</sup>     |                   |
| CoolFET <sup>TM</sup>             | FRFET <sup>TM</sup>              | PACMAN <sup>TM</sup>             | Stealth <sup>TM</sup>        |                   |
| CROSSVOLT <sup>TM</sup>           | GlobalOptoisolator <sup>TM</sup> | POP <sup>TM</sup>                | SuperSOT <sup>TM</sup> -3    |                   |
| DenseTrench <sup>TM</sup>         | GTO <sup>TM</sup>                | Power247 <sup>TM</sup>           | SuperSOT <sup>TM</sup> -6    |                   |
| DOMET <sup>TM</sup>               | HiSeC <sup>TM</sup>              | PowerTrench <sup>®</sup>         | SuperSOT <sup>TM</sup> -8    |                   |
| EcoSPARK <sup>TM</sup>            | ISOPLANAR <sup>TM</sup>          | QFET <sup>TM</sup>               | SyncFET <sup>TM</sup>        |                   |
| E <sup>2</sup> CMOS <sup>TM</sup> | LittleFET <sup>TM</sup>          | QS <sup>TM</sup>                 | TinyLogic <sup>TM</sup>      |                   |
| EnSigna <sup>TM</sup>             | MicroFET <sup>TM</sup>           | QT Optoelectronics <sup>TM</sup> | TruTranslation <sup>TM</sup> |                   |
| FACT <sup>TM</sup>                | MicroPak <sup>TM</sup>           | Quiet Series <sup>TM</sup>       | UHC <sup>TM</sup>            |                   |
| FACT Quiet Series <sup>TM</sup>   | MICROWIRE <sup>TM</sup>          | SILENT SWITCHER <sup>®</sup>     | UltraFET <sup>®</sup>        |                   |

STAR\*POWER is used under license

## DISCLAIMER

FAIRCHILD SEMICONDUCTOR RESERVES THE RIGHT TO MAKE CHANGES WITHOUT FURTHER NOTICE TO ANY PRODUCTS HEREIN TO IMPROVE RELIABILITY, FUNCTION OR DESIGN. FAIRCHILD DOES NOT ASSUME ANY LIABILITY ARISING OUT OF THE APPLICATION OR USE OF ANY PRODUCT OR CIRCUIT DESCRIBED HEREIN; NEITHER DOES IT CONVEY ANY LICENSE UNDER ITS PATENT RIGHTS, NOR THE RIGHTS OF OTHERS.

## LIFE SUPPORT POLICY

FAIRCHILD'S PRODUCTS ARE NOT AUTHORIZED FOR USE AS CRITICAL COMPONENTS IN LIFE SUPPORT DEVICES OR SYSTEMS WITHOUT THE EXPRESS WRITTEN APPROVAL OF FAIRCHILD SEMICONDUCTOR CORPORATION.

As used herein:

1. Life support devices or systems are devices or systems which, (a) are intended for surgical implant into the body, or (b) support or sustain life, or (c) whose failure to perform when properly used in accordance with instructions for use provided in the labeling, can be reasonably expected to result in significant injury to the user.
2. A critical component is any component of a life support device or system whose failure to perform can be reasonably expected to cause the failure of the life support device or system, or to affect its safety or effectiveness.

## PRODUCT STATUS DEFINITIONS

### Definition of Terms

| Datasheet Identification | Product Status         | Definition  |
|--------------------------|------------------------|---|
| Advance Information      | Formative or In Design | This datasheet contains the design specifications for product development. Specifications may change in any manner without notice.  |
| Preliminary              | First Production       | This datasheet contains preliminary data, and supplementary data will be published at a later date. Fairchild Semiconductor reserves the right to make changes at any time without notice in order to improve design. |
| No Identification Needed | Full Production        | This datasheet contains final specifications. Fairchild Semiconductor reserves the right to make changes at any time without notice in order to improve design.   |
| Obsolete                 | Not In Production      | This datasheet contains specifications on a product that has been discontinued by Fairchild semiconductor. The datasheet is printed for reference information only.   |

ON Semiconductor and  are trademarks of Semiconductor Components Industries, LLC dba ON Semiconductor or its subsidiaries in the United States and/or other countries. ON Semiconductor owns the rights to a number of patents, trademarks, copyrights, trade secrets, and other intellectual property. A listing of ON Semiconductor's product/patent coverage may be accessed at [www.onsemi.com/site/pdf/Patent-Marking.pdf](http://www.onsemi.com/site/pdf/Patent-Marking.pdf). ON Semiconductor reserves the right to make changes without further notice to any products herein. ON Semiconductor makes no warranty, representation or guarantee regarding the suitability of its products for any particular purpose, nor does ON Semiconductor assume any liability arising out of the application or use of any product or circuit, and specifically disclaims any and all liability, including without limitation special, consequential or incidental damages. Buyer is responsible for its products and applications using ON Semiconductor products, including compliance with all laws, regulations and safety requirements or standards, regardless of any support or applications information provided by ON Semiconductor. "Typical" parameters which may be provided in ON Semiconductor data sheets and/or specifications can and do vary in different applications and actual performance may vary over time. All operating parameters, including "Typicals" must be validated for each customer application by customer's technical experts. ON Semiconductor does not convey any license under its patent rights nor the rights of others. ON Semiconductor products are not designed, intended, or authorized for use as a critical component in life support systems or any FDA Class 3 medical devices or medical devices with a same or similar classification in a foreign jurisdiction or any devices intended for implantation in the human body. Should Buyer purchase or use ON Semiconductor products for any such unintended or unauthorized application, Buyer shall indemnify and hold ON Semiconductor and its officers, employees, subsidiaries, affiliates, and distributors harmless against all claims, costs, damages, and expenses, and reasonable attorney fees arising out of, directly or indirectly, any claim of personal injury or death associated with such unintended or unauthorized use, even if such claim alleges that ON Semiconductor was negligent regarding the design or manufacture of the part. ON Semiconductor is an Equal Opportunity/Affirmative Action Employer. This literature is subject to all applicable copyright laws and is not for resale in any manner.

## PUBLICATION ORDERING INFORMATION

### LITERATURE FULFILLMENT:

Literature Distribution Center for ON Semiconductor  
19521 E. 32nd Pkwy, Aurora, Colorado 80011 USA  
**Phone:** 303-675-2175 or 800-344-3860 Toll Free USA/Canada  
**Fax:** 303-675-2176 or 800-344-3867 Toll Free USA/Canada  
**Email:** [orderlit@onsemi.com](mailto:orderlit@onsemi.com)

**N. American Technical Support:** 800-282-9855 Toll Free  
USA/Canada  
**Europe, Middle East and Africa Technical Support:**  
Phone: 421 33 790 2910  
**Japan Customer Focus Center**  
Phone: 81-3-5817-1050

**ON Semiconductor Website:** [www.onsemi.com](http://www.onsemi.com)  
**Order Literature:** <http://www.onsemi.com/orderlit>  
For additional information, please contact your local  
Sales Representative