

- [RoHS Compliant, Halogen-Free](#) ②
- [Lead-Free \(Qualified up to 260°C Reflow\)](#) ①
- Application Specific MOSFETs
- Ideal for High Performance Isolated Converter Primary Switch Socket
- Optimized for Synchronous Rectification
- Low Conduction Losses
- High Cdv/dt Immunity
- Low Profile (<0.7mm)
- [Dual Sided Cooling Compatible](#) ①
- [Compatible with existing Surface Mount Techniques](#) ①

DirectFET™ Power MOSFET ②

Typical values (unless otherwise specified)

V_{DSS}	V_{GS}	R_{DS(on)}
100V max	±20V max	28mΩ @ 10V
Q_{g tot}	Q_{gd}	V_{gs(th)}
14nC	4.8nC	4.0V

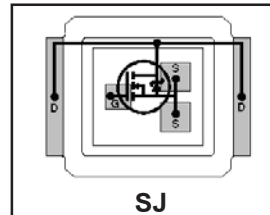

[Applicable DirectFET Outline and Substrate Outline \(see p.7,8 for details\)](#) ①

SH	SJ	SP		MZ	MN					
----	-----------	----	--	----	----	--	--	--	--	--

Description

The IRF6645PbF combines the latest HEXFET® Power MOSFET Silicon technology with the advanced DirectFET™ packaging to achieve the lowest on-state resistance in a package that has the footprint of an Micro8 and only 0.7 mm profile. The DirectFET package is compatible with existing layout geometries used in power applications, PCB assembly equipment and vapor phase, infra-red or convection soldering techniques, when application note [AN-1035](#) is followed regarding the manufacturing methods and processes. The DirectFET package allows dual sided cooling to maximize thermal transfer in power systems, improving previous best thermal resistance by 80%.

The IRF6645PbF is optimized for primary side bridge topologies in isolated DC-DC applications, for wide range universal input Telecom applications (36V - 75V), and for secondary side synchronous rectification in regulated DC-DC topologies. The reduced total losses in the device coupled with the high level of thermal performance enables high efficiency and low temperatures, which are key for system reliability improvements, and makes this device ideal for high performance isolated DC-DC converters.

Absolute Maximum Ratings

	Parameter	Max.	Units
V _{DS}	Drain-to-Source Voltage	100	V
V _{GS}	Gate-to-Source Voltage	±20	
I _D @ T _A = 25°C	Continuous Drain Current, V _{GS} @ 10V ③	5.7	A
I _D @ T _A = 70°C	Continuous Drain Current, V _{GS} @ 10V ③	4.5	
I _D @ T _C = 25°C	Continuous Drain Current, V _{GS} @ 10V ④	25	
I _{DM}	Pulsed Drain Current ⑤	45	
E _{AS}	Single Pulse Avalanche Energy ⑥	29	mJ
I _{AR}	Avalanche Current ⑤	3.4	A

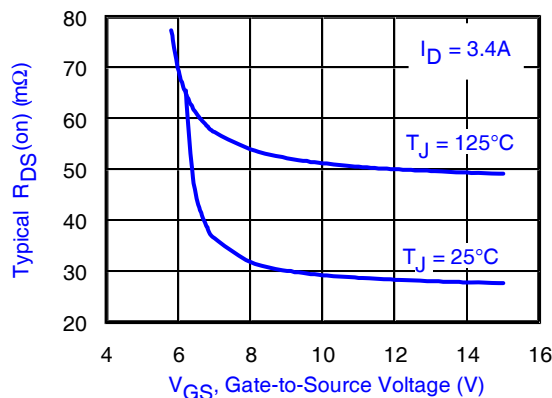

Fig 1. Typical On-Resistance vs. Gate Voltage

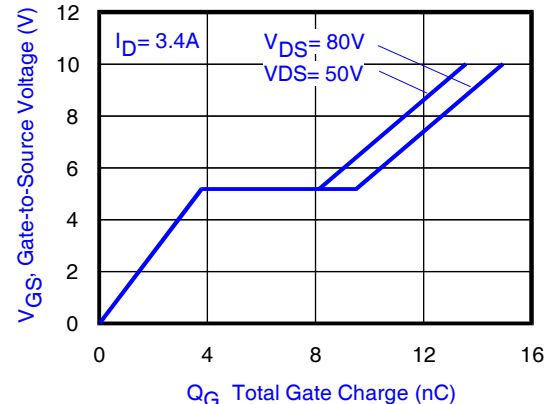

Fig 2. Typical Total Gate Charge vs. Gate-to-Source Voltage

Notes:

- ① Click on this section to link to the appropriate technical paper.
- ② Click on this section to link to the DirectFET Website.
- ③ Surface mounted on 1 in. square Cu board, steady state.
- ④ T_C measured with thermocouple mounted to top (Drain) of part.
- ⑤ Repetitive rating; pulse width limited by max. junction temperature.
- ⑥ Starting T_J = 25°C, L = 5.0mH, R_G = 25Ω, I_{AS} = 3.4A.

Electrical Characteristic @ T_J = 25°C (unless otherwise specified)

	Parameter	Min.	Typ.	Max.	Units	Conditions
BV _{DSS}	Drain-to-Source Breakdown Voltage	100	—	—	V	V _{GS} = 0V, I _D = 250μA
ΔBV _{DSS} /ΔT _J	Breakdown Voltage Temp. Coefficient	—	0.12	—	V/°C	Reference to 25°C, I _D = 1mA
R _{DS(on)}	Static Drain-to-Source On-Resistance	—	28	35	mΩ	V _{GS} = 10V, I _D = 5.7A ⑦
V _{GS(th)}	Gate Threshold Voltage	3.0	—	4.9	V	V _{DS} = V _{GS} , I _D = 50μA
ΔV _{GS(th)} /ΔT _J	Gate Threshold Voltage Coefficient	—	-12	—	mV/°C	
I _{DSS}	Drain-to-Source Leakage Current	—	—	20	μA	V _{DS} = 100V, V _{GS} = 0V
		—	—	250		V _{DS} = 80V, V _{GS} = 0V, T _J = 125°C
I _{GSS}	Gate-to-Source Forward Leakage	—	—	100	nA	V _{GS} = 20V
	Gate-to-Source Reverse Leakage	—	—	-100		V _{GS} = -20V
gfs	Forward Transconductance	7.4	—	—	S	V _{DS} = 10V, I _D = 3.4A
Q _g	Total Gate Charge	—	14	20	nC	V _{DS} = 50V V _{GS} = 10V I _D = 3.4A See Fig. 15
Q _{gs1}	Pre-V _{th} Gate-to-Source Charge	—	3.1	—		
Q _{gs2}	Post-V _{th} Gate-to-Source Charge	—	0.8	—		
Q _{gd}	Gate-to-Drain Charge	—	4.8	7.2		
Q _{godr}	Gate Charge Overdrive	—	5.3	—		
Q _{sw}	Switch Charge (Q _{gs2} + Q _{gd})	—	5.6	—		
Q _{oss}	Output Charge	—	7.2	—	nC	V _{DS} = 16V, V _{GS} = 0V
R _G	Gate Resistance	—	1.0	—	Ω	
t _{d(on)}	Turn-On Delay Time	—	9.2	—	ns	V _{DD} = 50V, V _{GS} = 10V ⑦ I _D = 3.4A R _G = 6.2Ω
t _r	Rise Time	—	5.0	—		
t _{d(off)}	Turn-Off Delay Time	—	18	—		
t _f	Fall Time	—	5.1	—		
C _{iss}	Input Capacitance	—	890	—	pF	V _{GS} = 0V V _{DS} = 25V f = 1.0MHz
C _{oss}	Output Capacitance	—	180	—		
C _{rss}	Reverse Transfer Capacitance	—	40	—		
C _{oss}	Output Capacitance	—	870	—		
C _{oss}	Output Capacitance	—	100	—		
						V _{GS} = 0V, V _{DS} = 80V, f = 1.0MHz

Diode Characteristics

	Parameter	Min.	Typ.	Max.	Units	Conditions
I _S	Continuous Source Current (Body Diode)	—	—	25	A	MOSFET symbol showing the integral reverse p-n junction diode.
I _{SM}	Pulsed Source Current (Body Diode) ⑤	—	—	45		
V _{SD}	Diode Forward Voltage	—	—	1.3	V	T _J = 25°C, I _S = 3.4A, V _{GS} = 0V ⑦
t _{rr}	Reverse Recovery Time	—	31	47	ns	T _J = 25°C, I _F = 3.4A, V _{DD} = 50V
Q _{rr}	Reverse Recovery Charge	—	40	60	nC	di/dt = 100A/μs ①

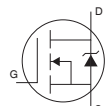
Notes:

- ⑤ Repetitive rating; pulse width limited by max. junction temperature.
- ⑦ Pulse width ≤ 400μs; duty cycle ≤ 2%.

Absolute Maximum Ratings

	Parameter	Max.	Units
$P_D @ T_A = 25^\circ\text{C}$	Power Dissipation ③	2.2	W
$P_D @ T_A = 70^\circ\text{C}$	Power Dissipation ③	1.4	
$P_D @ T_C = 25^\circ\text{C}$	Power Dissipation ④	42	
T_P	Peak Soldering Temperature	270	$^\circ\text{C}$
T_J	Operating Junction and	-40 to + 150	
T_{STG}	Storage Temperature Range		

Thermal Resistance

	Parameter	Typ.	Max.	Units
$R_{\theta JA}$	Junction-to-Ambient ③ⓐ	—	58	$^\circ\text{C/W}$
$R_{\theta JA}$	Junction-to-Ambient ③ⓐ	12.5	—	
$R_{\theta JA}$	Junction-to-Ambient ③ⓐ	20	—	
$R_{\theta JC}$	Junction-to-Case ④ⓐ	—	3.0	
$R_{\theta J-PCB}$	Junction-to-PCB Mounted	1.0	—	

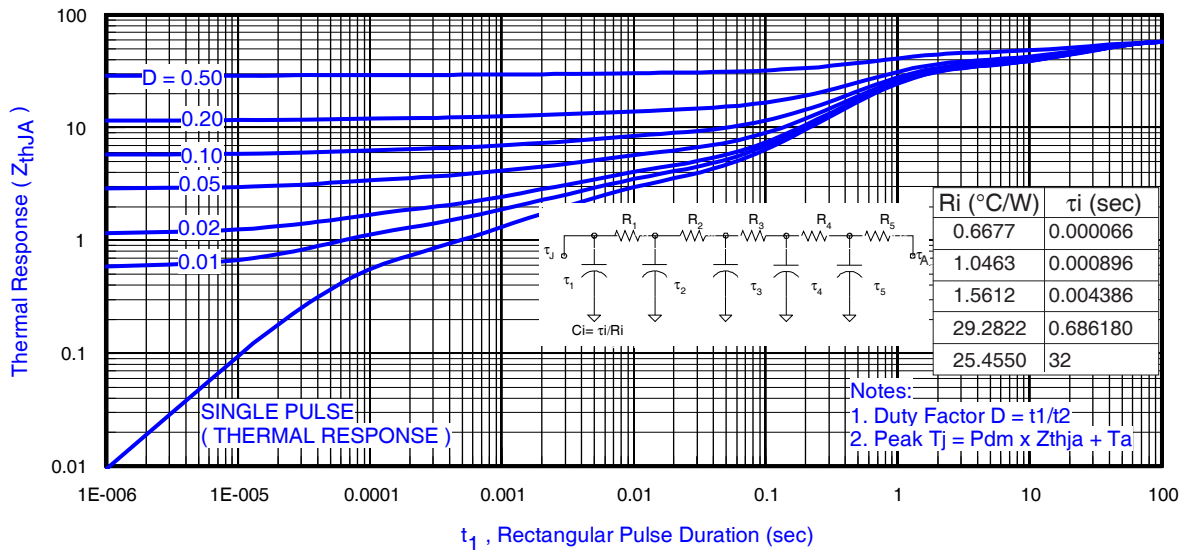
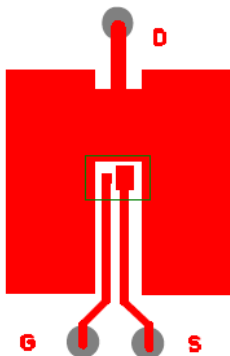

Fig 3. Maximum Effective Transient Thermal Impedance, Junction-to-Ambient ①

Notes:

- ③ Surface mounted on 1 in. square Cu board, steady state.
- ④ T_C measured with thermocouple incontact with top (Drain) of part.
- ⑧ Used double sided cooling, mounting pad with large heatsink.
- ⑨ Mounted on minimum footprint full size board with metalized back and with small clip heatsink.
- ⑩ R_{θ} is measured at T_J of approximately 90°C .



③ Surface mounted on 1 in. square Cu board (still air).

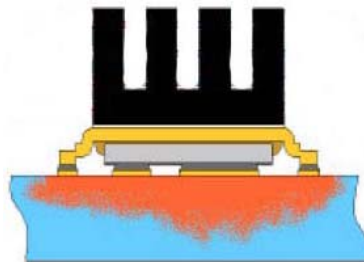

⑨ Mounted to a PCB with small clip heatsink (still air)

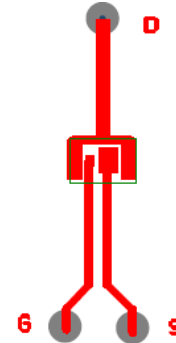

⑩ Mounted on minimum footprint full size board with metalized back and with small clip heatsink (still air)

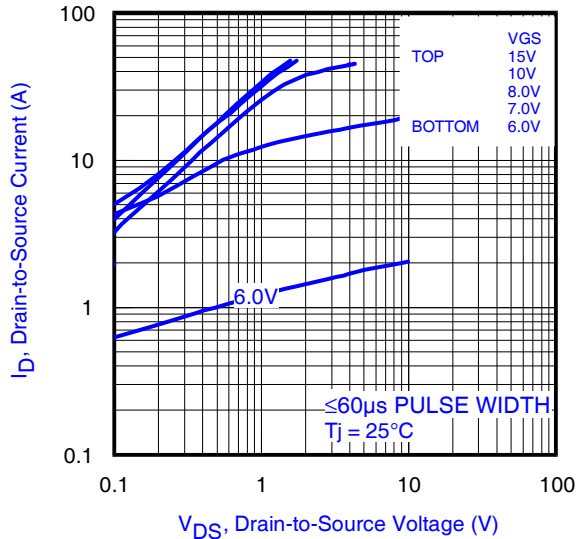

Fig 4. Typical Output Characteristics

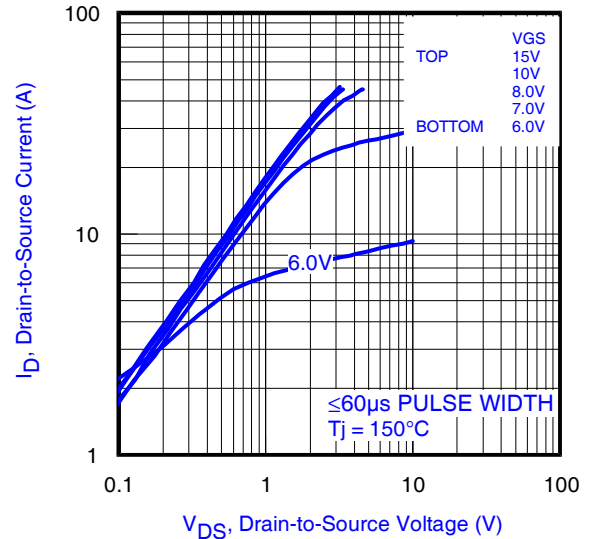

Fig 5. Typical Output Characteristics

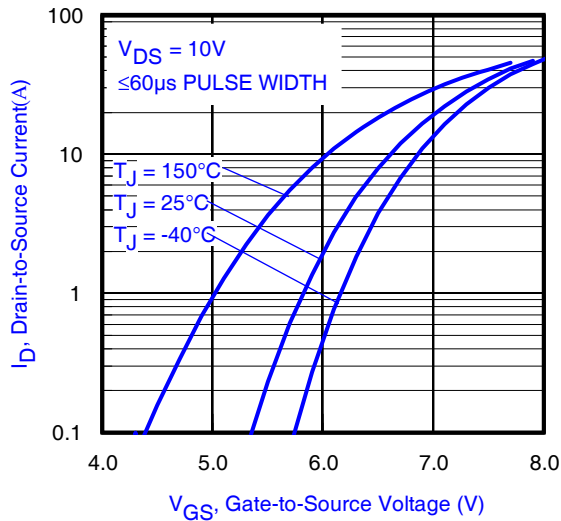

Fig 6. Typical Transfer Characteristics

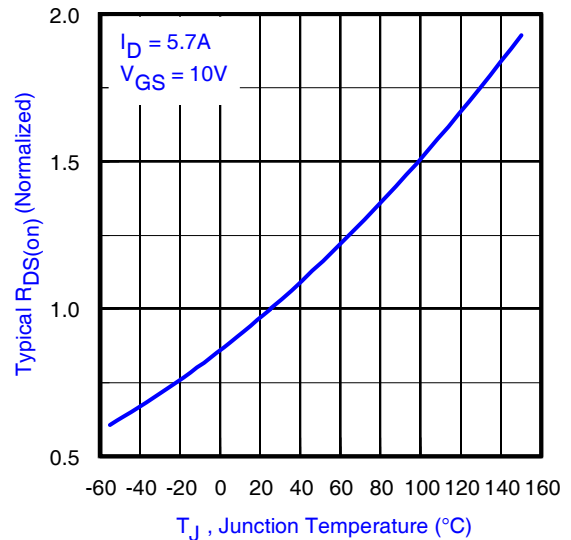

Fig 7. Normalized On-Resistance vs. Temperature

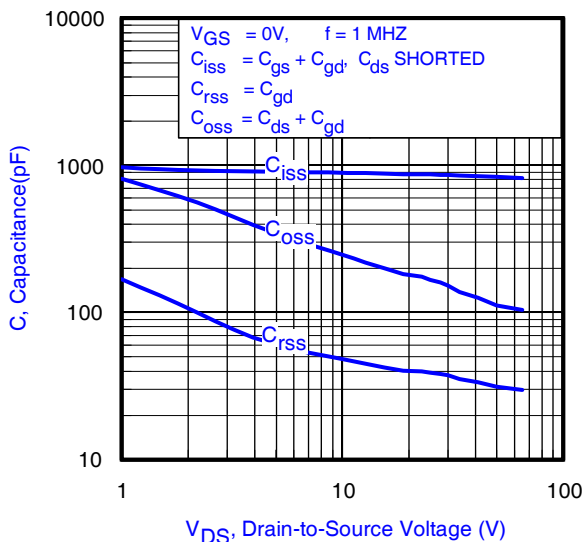

Fig 8. Typical Capacitance vs. Drain-to-Source Voltage

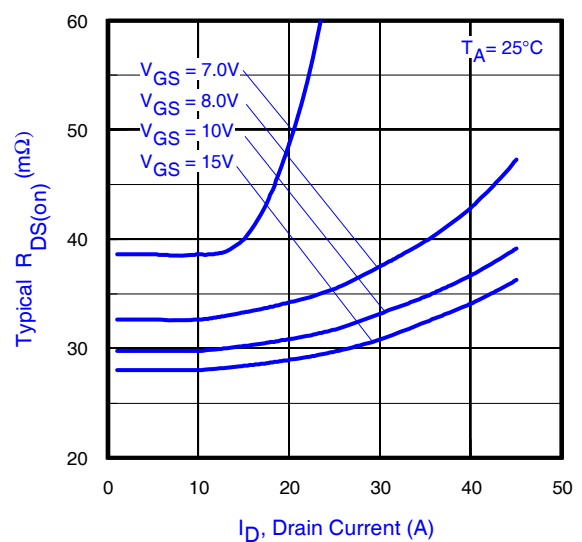

Fig 9. Typical On-Resistance vs. Drain Current

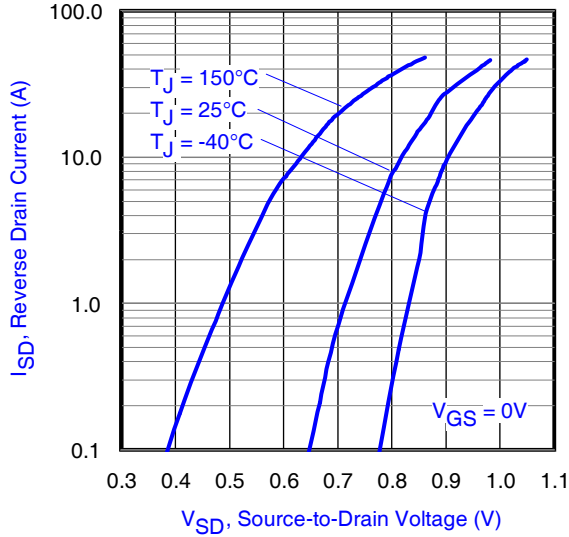

Fig 10. Typical Source-Drain Diode Forward Voltage

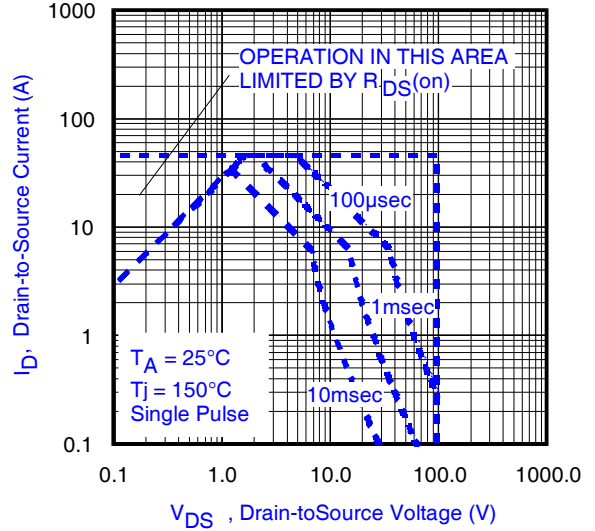

Fig11. Maximum Safe Operating Area

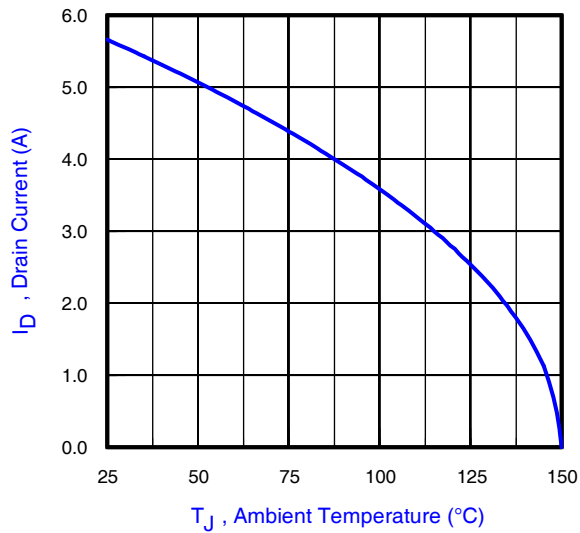

Fig 12. Maximum Drain Current vs. Ambient Temperature

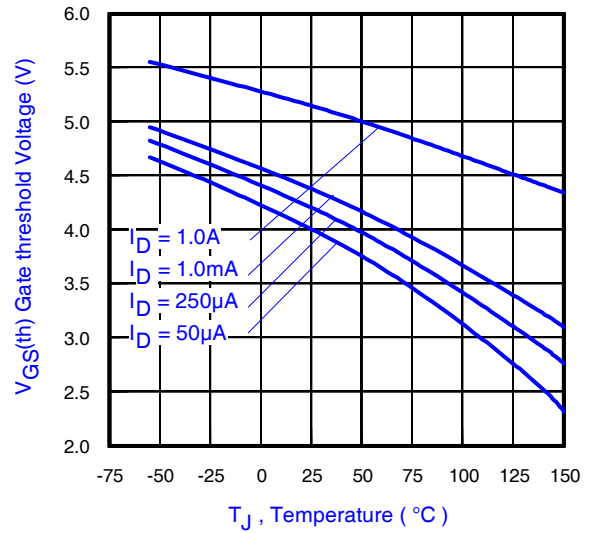

Fig 13. Typical Threshold Voltage vs. Junction Temperature

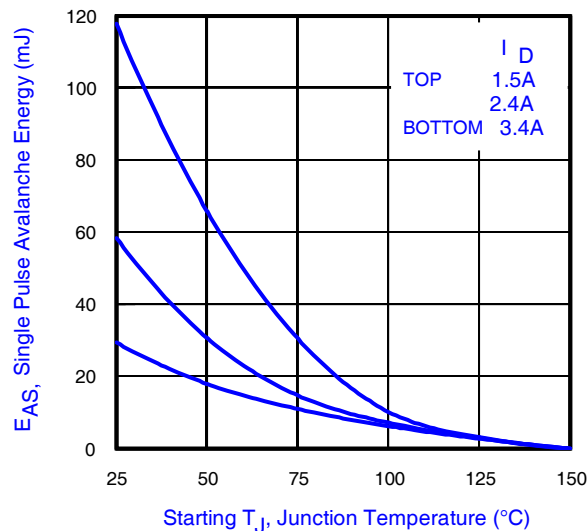

Fig 14. Maximum Avalanche Energy vs. Drain Current

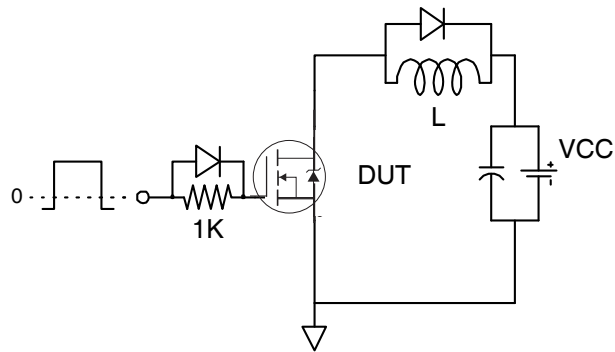

Fig 15a. Gate Charge Test Circuit

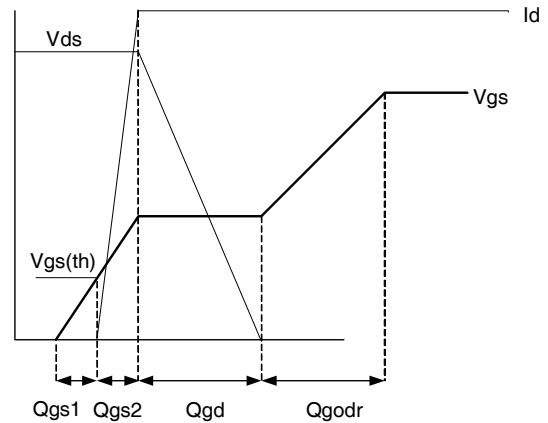

Fig 15b. Gate Charge Waveform

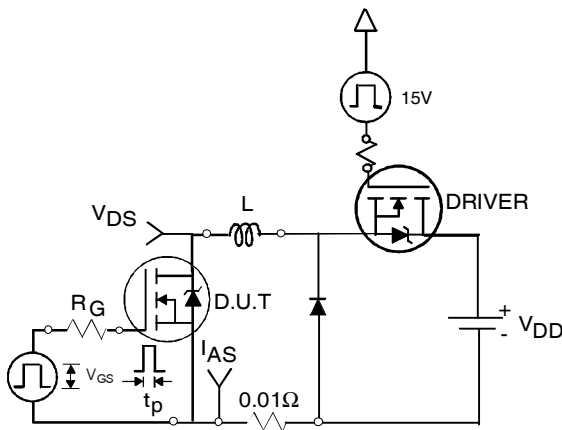

Fig 16b. Unclamped Inductive Test Circuit

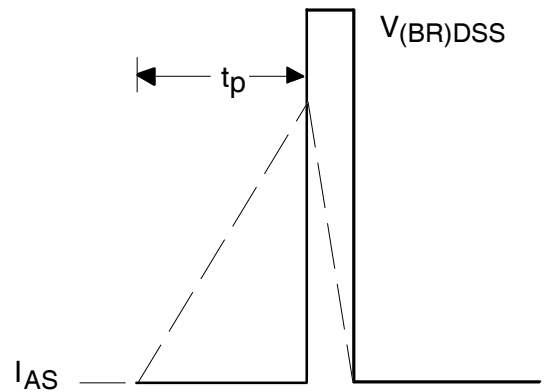

Fig 16c. Unclamped Inductive Waveforms

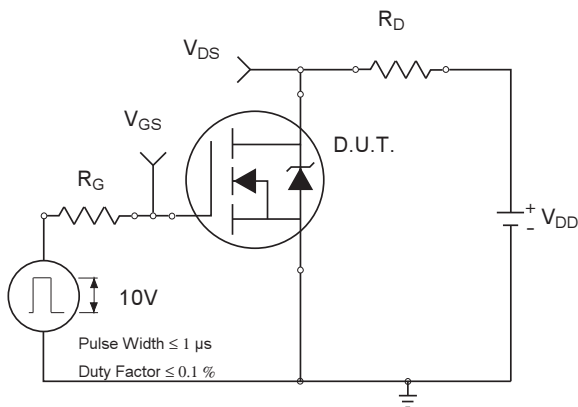

Fig 17a. Switching Time Test Circuit

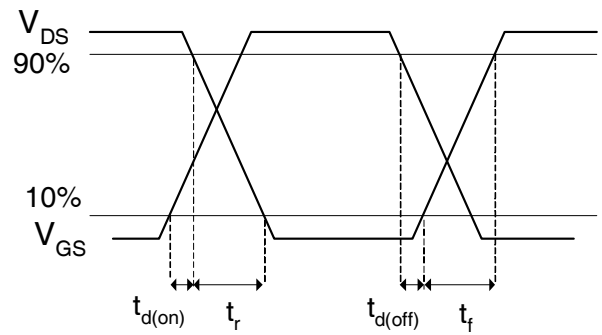

Fig 17b. Switching Time Waveforms

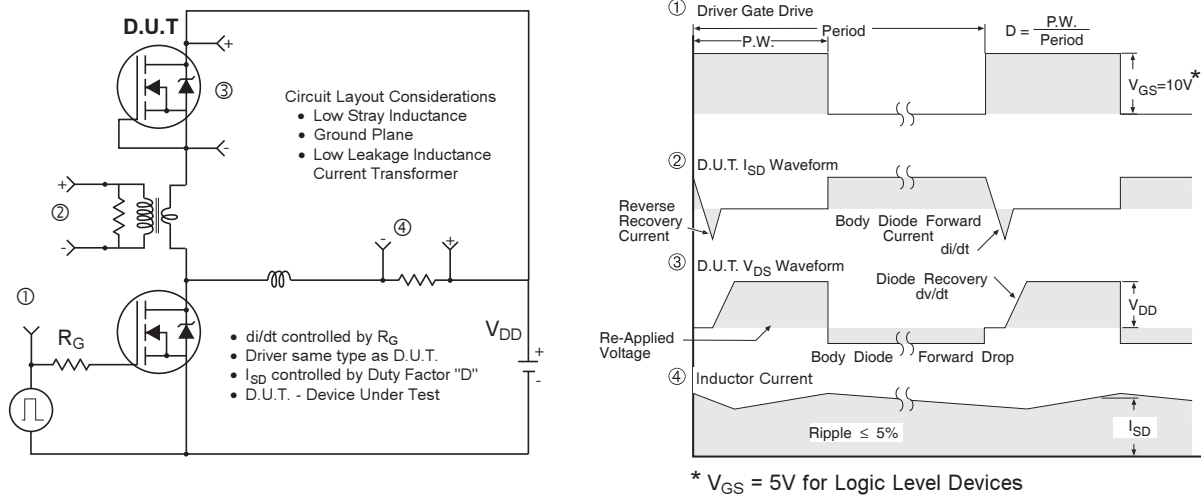
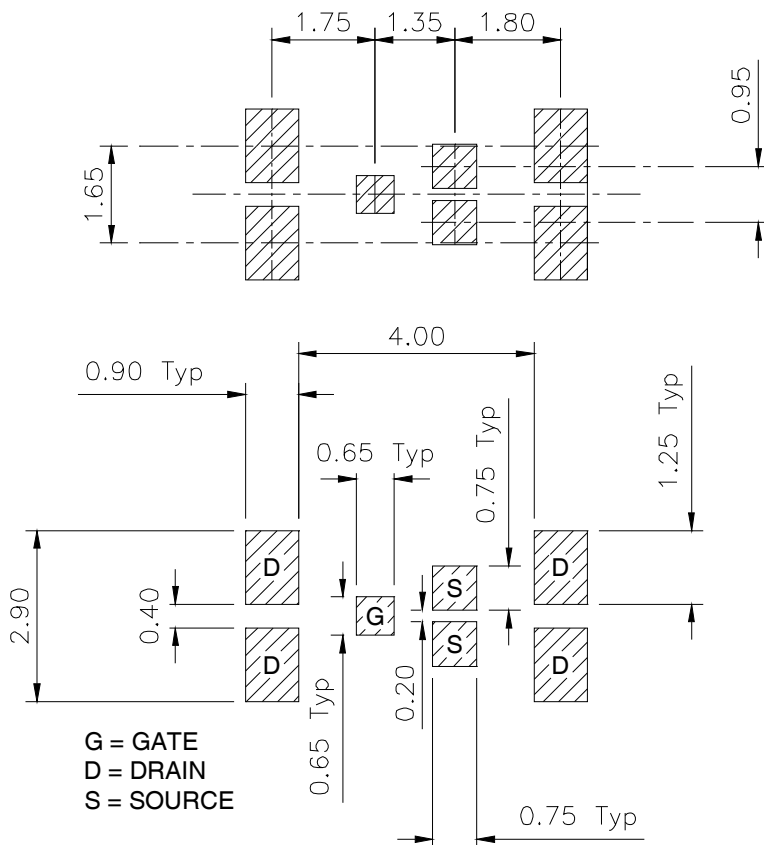

Fig 18. Diode Reverse Recovery Test Circuit for N-Channel HEXFET® Power MOSFETs

DirectFET™ Substrate and PCB Layout, SJ Outline (Small Size Can, J-Designation).

Please see DirectFET application note [AN-1035](#) for all details regarding the assembly of DirectFET. This includes all recommendations for stencil and substrate designs.



Note: For the most current drawing please refer to IR website at <http://www.irf.com/package>

**DirectFET™ Outline Dimension, SJ Outline
(Small Size Can, J-Designation).**

Please see DirectFET application note [AN-1035](#) for all details regarding the assembly of DirectFET. This includes all recommendations for stencil and substrate designs.

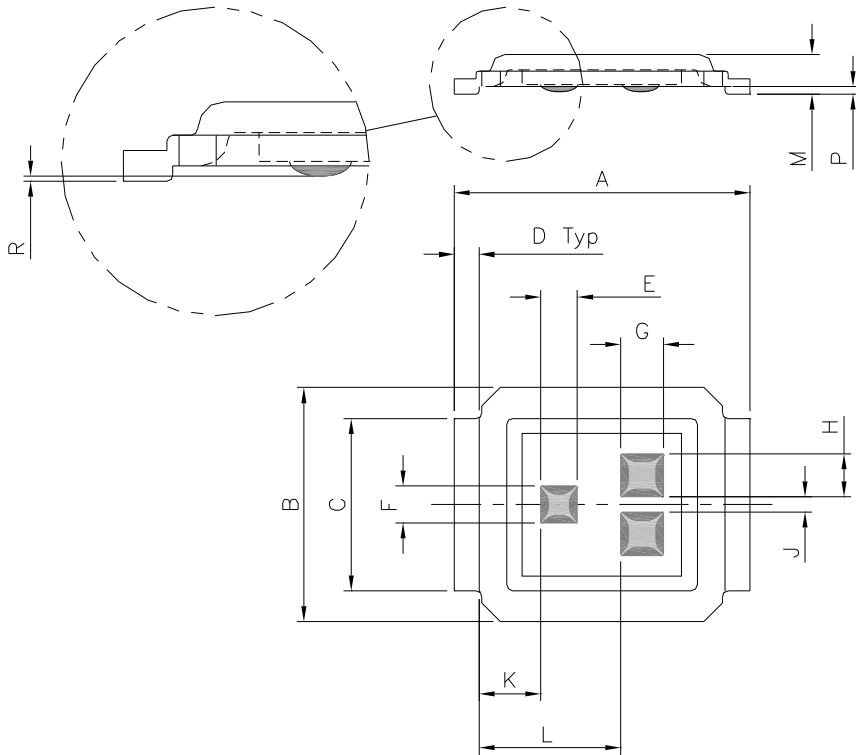

CODE	METRIC		IMPERIAL	
	MIN	MAX	MIN	MAX
A	4.75	4.85	0.187	0.191
B	3.70	3.95	0.146	0.156
C	2.75	2.85	0.108	0.112
D	0.35	0.45	0.014	0.018
E	0.58	0.62	0.023	0.024
F	0.58	0.62	0.023	0.024
G	0.68	0.72	0.027	0.028
H	0.68	0.72	0.027	0.028
J	0.23	0.27	0.009	0.010
K	0.95	1.05	0.037	0.041
L	2.25	2.35	0.089	0.093
M	0.59	0.70	0.023	0.028
P	0.08	0.17	0.003	0.007
R	0.020	0.080	0.0008	0.0031

DirectFET™ Part Marking

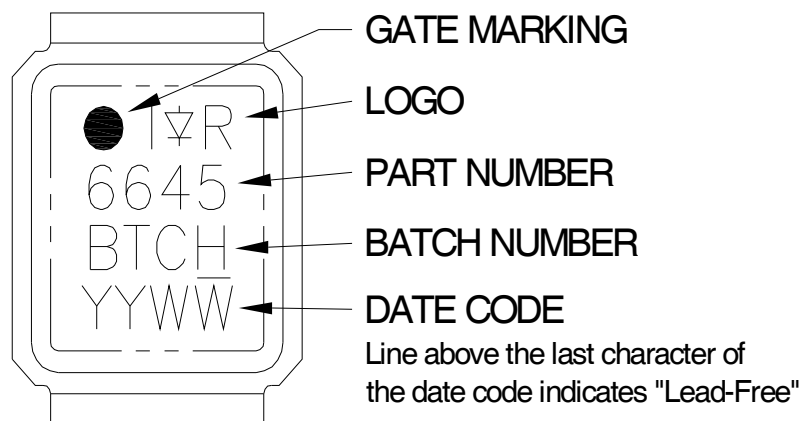

Note: For the most current drawing please refer to IR website at <http://www.irf.com/package>

DirectFET™ Tape & Reel Dimension (Showing component orientation).

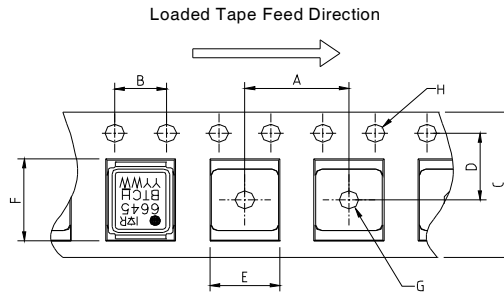
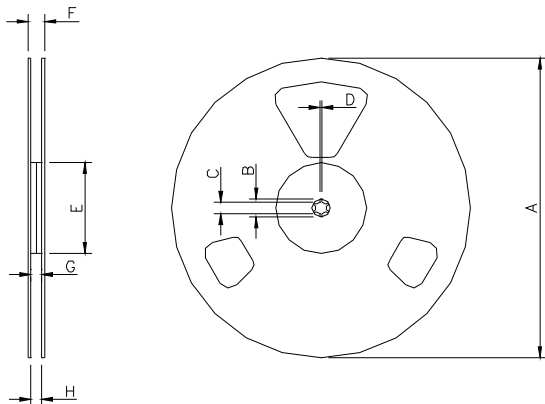

NOTE: Controlling dimensions in mm
 Std reel quantity is 4800 parts. (ordered as IRF6645TRPBF). For 1000 parts on 7" reel, order IRF6645TR1PBF

CODE	METRIC		IMPERIAL	
	MIN	MAX	MIN	MAX
A	7.90	8.10	0.311	0.319
B	3.90	4.10	0.154	0.161
C	11.90	12.30	0.469	0.484
D	5.45	5.55	0.215	0.219
E	4.00	4.20	0.158	0.165
F	5.00	5.20	0.197	0.205
G	1.50	N.C	0.059	N.C
H	1.50	1.60	0.059	0.063

REEL DIMENSIONS								
CODE	STANDARD OPTION (QTY 4800)				TR1 OPTION (QTY 1000)			
	METRIC		IMPERIAL		METRIC		IMPERIAL	
	MIN	MAX	MIN	MAX	MIN	MAX	MIN	MAX
A	330.0	N.C	12.992	N.C	177.77	N.C	6.9	N.C
B	20.2	N.C	0.795	N.C	19.06	N.C	0.75	N.C
C	12.8	13.2	0.504	0.520	13.5	12.8	0.53	0.50
D	1.5	N.C	0.059	N.C	1.5	N.C	0.059	N.C
E	100.0	N.C	3.937	N.C	58.72	N.C	2.31	N.C
F	N.C	18.4	N.C	0.724	N.C	13.50	N.C	0.53
G	12.4	14.4	0.488	0.567	11.9	12.01	0.47	N.C
H	11.9	15.4	0.469	0.606	11.9	12.01	0.47	N.C

Note: For the most current drawing please refer to IR website at <http://www.irf.com/package>

Revision History

Date	Comments
12/10/2012	Updated package outline, on page 8.
2/26/2013	Updated P _D @ T _A = 25C from 3W to 2.2W, on page 3.

This product has been designed and qualified for the Consumer market.
 Qualification Standards can be found on IR's Web site.
 Data and specifications subject to change without notice.