

HEXFET[®] Power MOSFET

- Generation V Technology
- Ultra Low On-Resistance
- Dual P-Channel MOSFET
- Surface Mount
- Fully Avalanche Rated

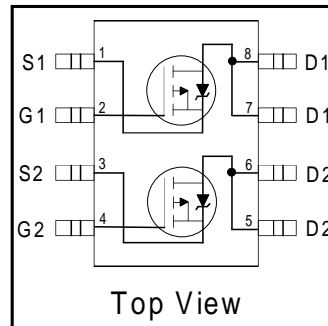

$V_{DS} = -20V$

$R_{DS(on)} = 0.058\Omega$

Description

Fifth Generation HEXFETs from International Rectifier utilize advanced processing techniques to achieve extremely low on-resistance per silicon area. This benefit, combined with the fast switching speed and ruggedized device design that HEXFET Power MOSFETs are well known for, provides the designer with an extremely efficient and reliable device for use in a wide variety of applications.

The SO-8 has been modified through a customized leadframe for enhanced thermal characteristics and multiple-die capability making it ideal in a variety of power applications. With these improvements, multiple devices can be used in an application with dramatically reduced board space. The package is designed for vapor phase, infra red, or wave soldering techniques.

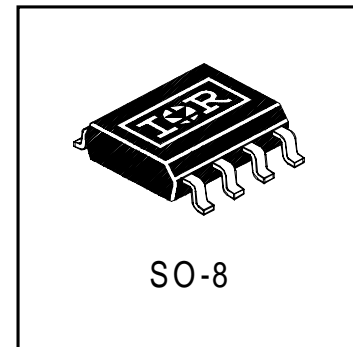

Absolute Maximum Ratings ($T_A = 25^\circ C$ Unless Otherwise Noted)

	Symbol	Maximum	Units
Drain-Source Voltage	V_{DS}	-20	V
Gate-Source Voltage	V_{GS}	± 12	
Continuous Drain Current ^⑤	I_D	$T_A = 25^\circ C$	-5.3
		$T_A = 70^\circ C$	-4.3
Pulsed Drain Current	I_{DM}	-21	A
Continuous Source Current (Diode Conduction)	I_S	-2.5	
Maximum Power Dissipation ^⑤	P_D	$T_A = 25^\circ C$	2.0
		$T_A = 70^\circ C$	1.3
Single Pulse Avalanche Energy	E_{AS}	150	mJ
Avalanche Current	I_{AR}	-2.9	A
Repetitive Avalanche Energy	E_{AR}	0.20	mJ
Peak Diode Recovery dv/dt ^③	dv/dt	-5.0	V/ ns
Junction and Storage Temperature Range	T_J, T_{STG}	-55 to + 150	$^\circ C$

Thermal Resistance Ratings

Parameter	Symbol	Limit	Units
Maximum Junction-to-Ambient ^⑤	$R_{\theta JA}$	62.5	$^\circ C/W$

Electrical Characteristics @ $T_J = 25^\circ\text{C}$ (unless otherwise specified)

	Parameter	Min.	Typ.	Max.	Units	Conditions
$V_{(BR)DSS}$	Drain-to-Source Breakdown Voltage	-20	—	—	V	$V_{GS} = 0V, I_D = -250\mu A$
$\Delta V_{(BR)DSS}/\Delta T_J$	Breakdown Voltage Temp. Coefficient	—	0.031	—	V/ $^\circ\text{C}$	Reference to $25^\circ\text{C}, I_D = -1\text{mA}$
$R_{DS(on)}$	Static Drain-to-Source On-Resistance	—	0.049	0.058	Ω	$V_{GS} = -4.5V, I_D = -2.9A$ ④
		—	0.082	0.098		$V_{GS} = -2.7V, I_D = -1.5A$ ④
$V_{GS(th)}$	Gate Threshold Voltage	-0.70	—	—	V	$V_{DS} = V_{GS}, I_D = -250\mu A$
g_{fs}	Forward Transconductance	—	5.9	—	S	$V_{DS} = -10V, I_D = -1.5A$
I_{DSS}	Drain-to-Source Leakage Current	—	—	-1.0	μA	$V_{DS} = -16V, V_{GS} = 0V$
		—	—	-25		$V_{DS} = -16V, V_{GS} = 0V, T_J = 55^\circ\text{C}$
I_{GSS}	Gate-to-Source Forward Leakage	—	—	100	nA	$V_{GS} = -12V$
	Gate-to-Source Reverse Leakage	—	—	-100		$V_{GS} = 12V$
Q_g	Total Gate Charge	—	19	29	nC	$I_D = -2.9A$
Q_{gs}	Gate-to-Source Charge	—	4.0	6.1		$V_{DS} = -16V$
Q_{gd}	Gate-to-Drain ("Miller") Charge	—	7.7	12		$V_{GS} = -4.5V$, See Fig. 10 ④
$t_{d(on)}$	Turn-On Delay Time	—	15	22	ns	$V_{DD} = -10V$
t_r	Rise Time	—	40	60		$I_D = -2.9A$
$t_{d(off)}$	Turn-Off Delay Time	—	42	63		$R_G = 6.0\Omega$
t_f	Fall Time	—	49	73		$R_D = 3.4\Omega$ ④
C_{iss}	Input Capacitance	—	780	—	pF	$V_{GS} = 0V$
C_{oss}	Output Capacitance	—	470	—		$V_{DS} = -15V$
C_{rss}	Reverse Transfer Capacitance	—	240	—		$f = 1.0\text{MHz}$, See Fig. 5

Source-Drain Ratings and Characteristics

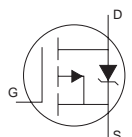
	Parameter	Min.	Typ.	Max.	Units	Conditions
I_S	Continuous Source Current (Body Diode)	—	—	-2.5	A	MOSFET symbol showing the integral reverse p-n junction diode. 
I_{SM}	Pulsed Source Current (Body Diode) ①	—	—	-21		
V_{SD}	Diode Forward Voltage	—	-0.78	-1.0	V	$T_J = 25^\circ\text{C}, I_S = -2.9A, V_{GS} = 0V$ ③
t_{rr}	Reverse Recovery Time	—	47	71	ns	$T_J = 25^\circ\text{C}, I_F = -2.9A$
Q_{rr}	Reverse Recovery Charge	—	49	73	nC	$di/dt = 100A/\mu s$ ③

Notes:

- ① Repetitive rating; pulse width limited by max. junction temperature. (See fig. 11)
- ② Starting $T_J = 25^\circ\text{C}$, $L = 35\text{mH}$
 $R_G = 25\Omega, I_{AS} = -2.9A$.
- ③ $I_{SD} \leq -2.9A, di/dt \leq -77A/\mu s, V_{DD} \leq V_{(BR)DSS}, T_J \leq 150^\circ\text{C}$
- ④ Pulse width $\leq 300\mu s$; duty cycle $\leq 2\%$.
- ⑤ Surface mounted on FR-4 board, $t \leq 10\text{sec}$.

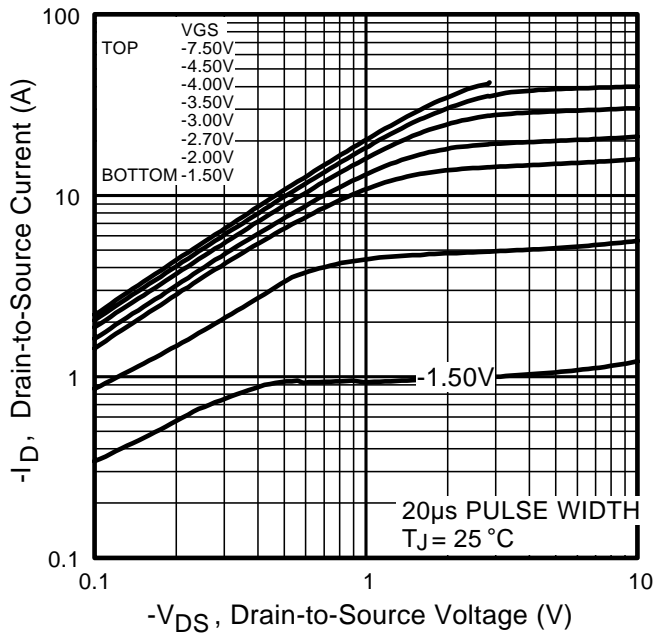

Fig 1. Typical Output Characteristics

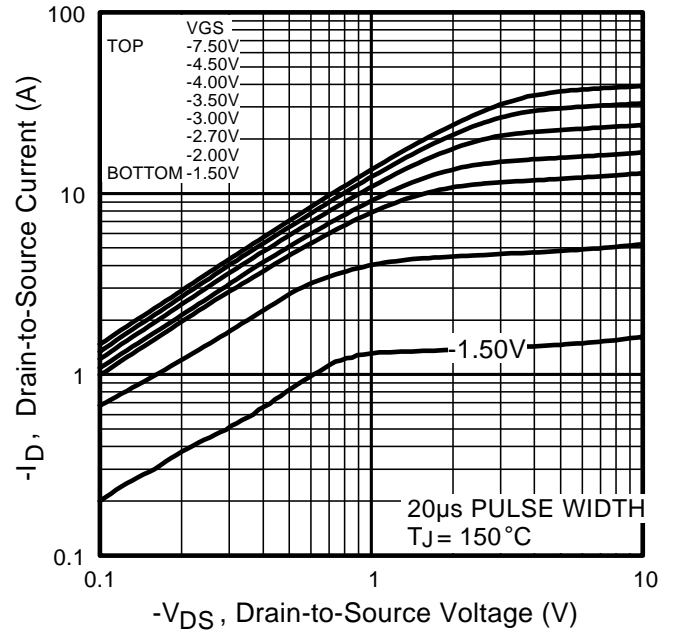

Fig 2. Typical Output Characteristics

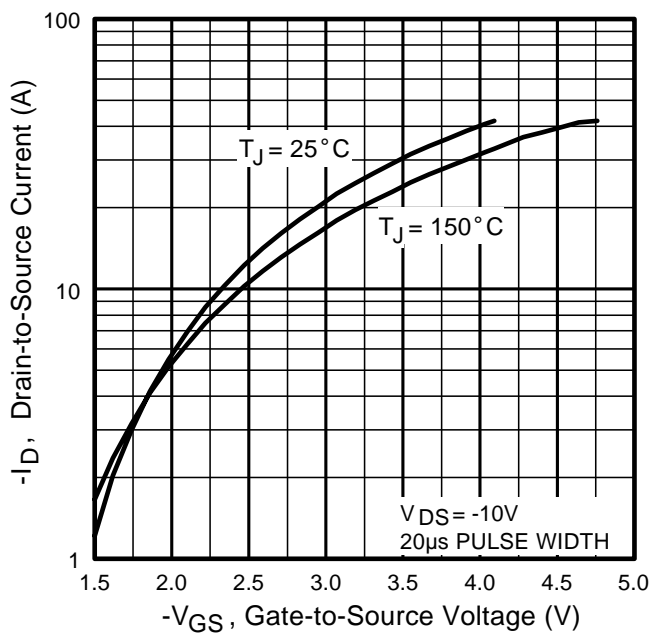

Fig 3. Typical Transfer Characteristics

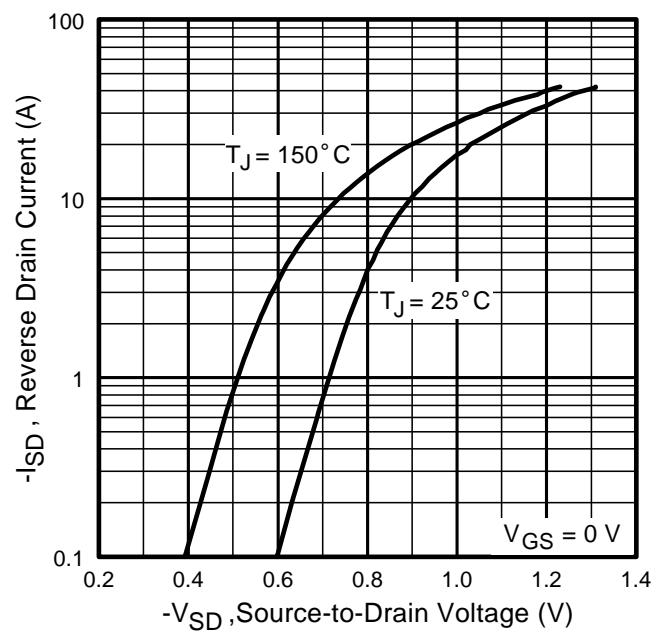

Fig 4. Typical Source-Drain Diode Forward Voltage

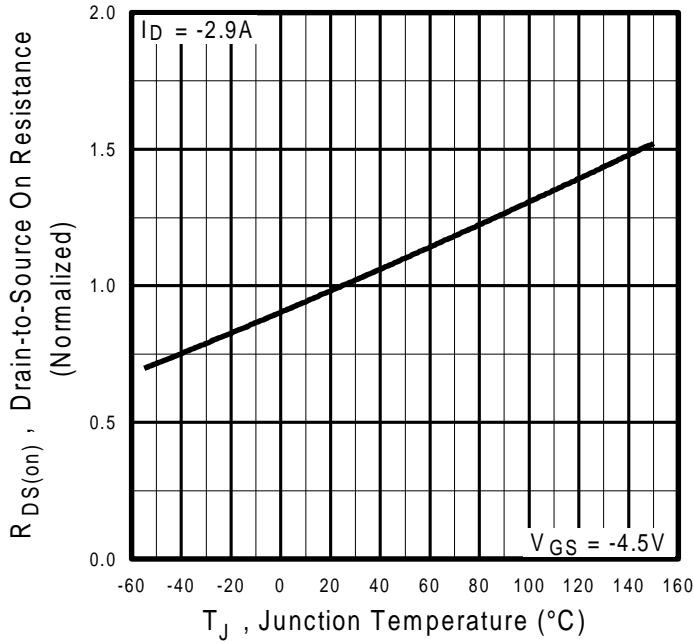

Fig 5. Normalized On-Resistance Vs. Temperature

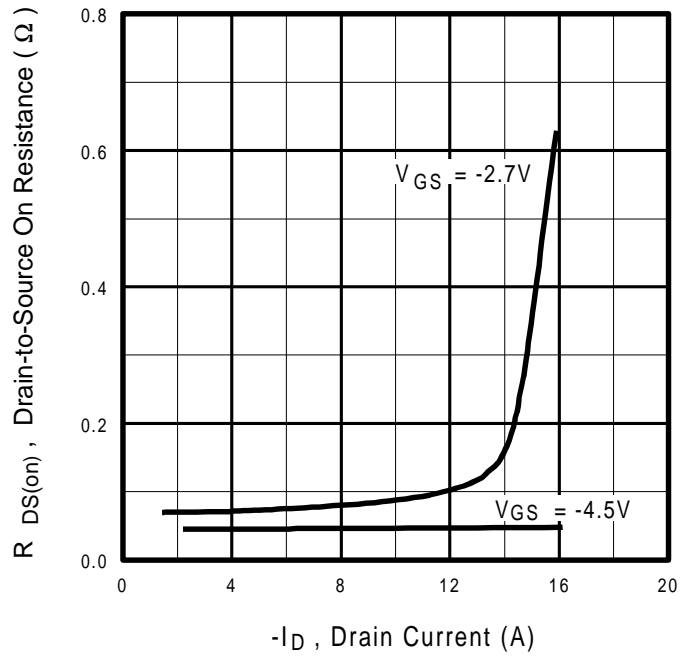

Fig 6. Typical On-Resistance Vs. Drain Current

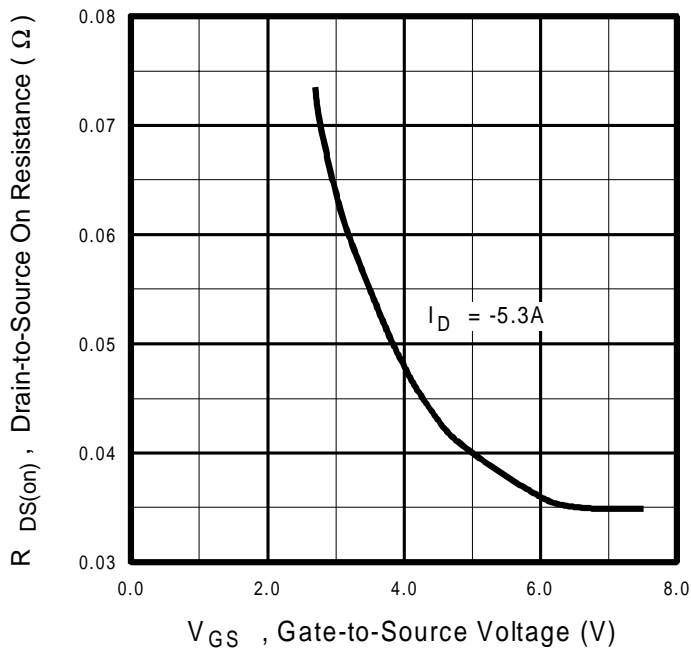

Fig 7. Typical On-Resistance Vs. Gate Voltage

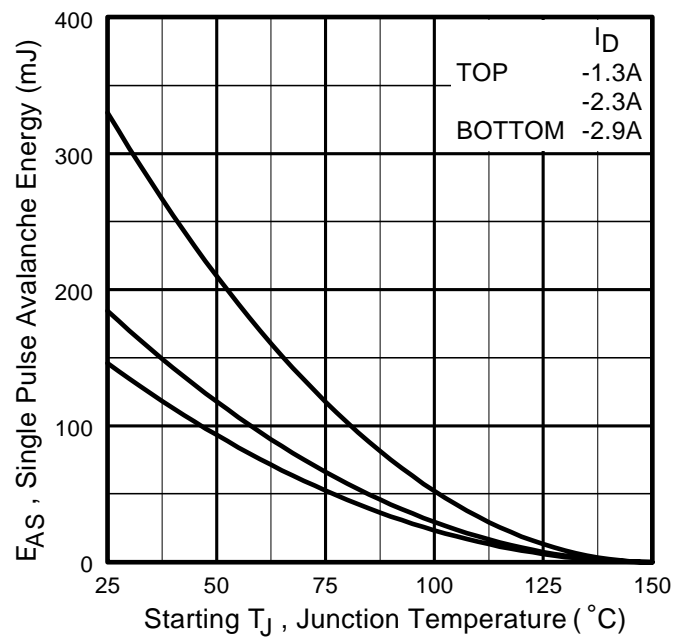

Fig 8. Maximum Avalanche Energy Vs. Drain Current

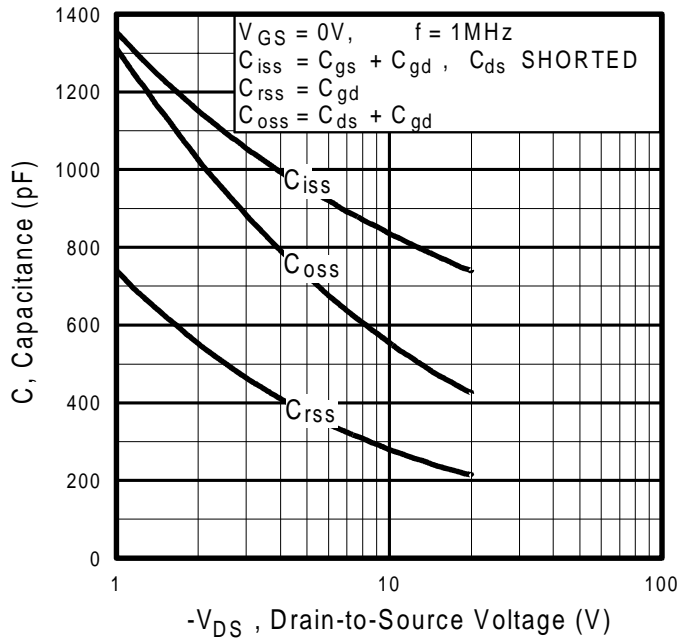

Fig 9. Typical Capacitance Vs. Drain-to-Source Voltage

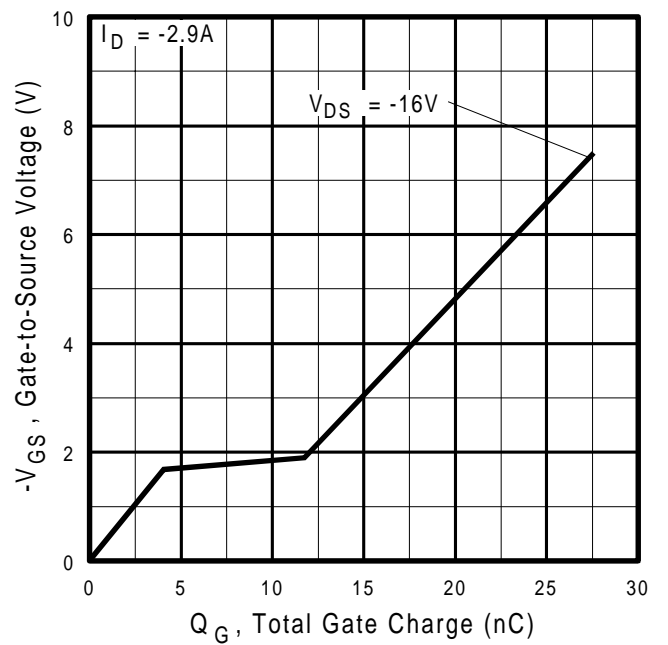

Fig 10. Typical Gate Charge Vs. Gate-to-Source Voltage

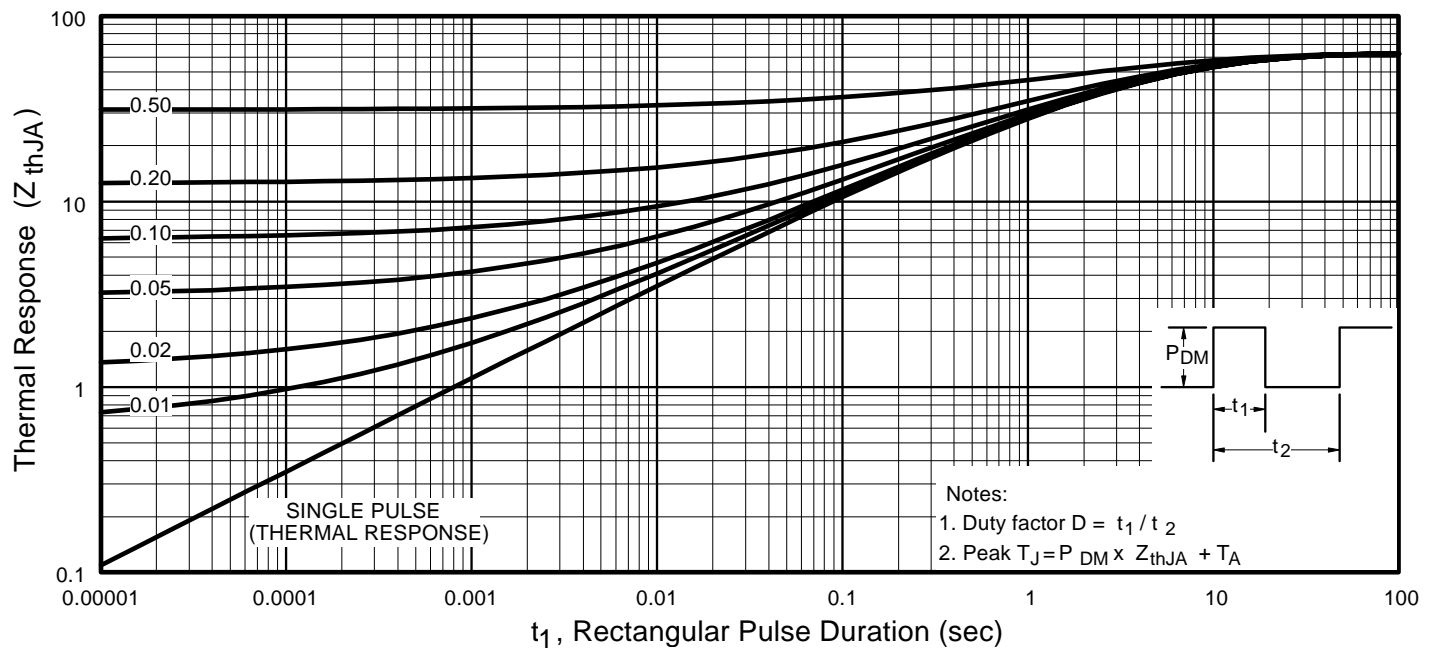
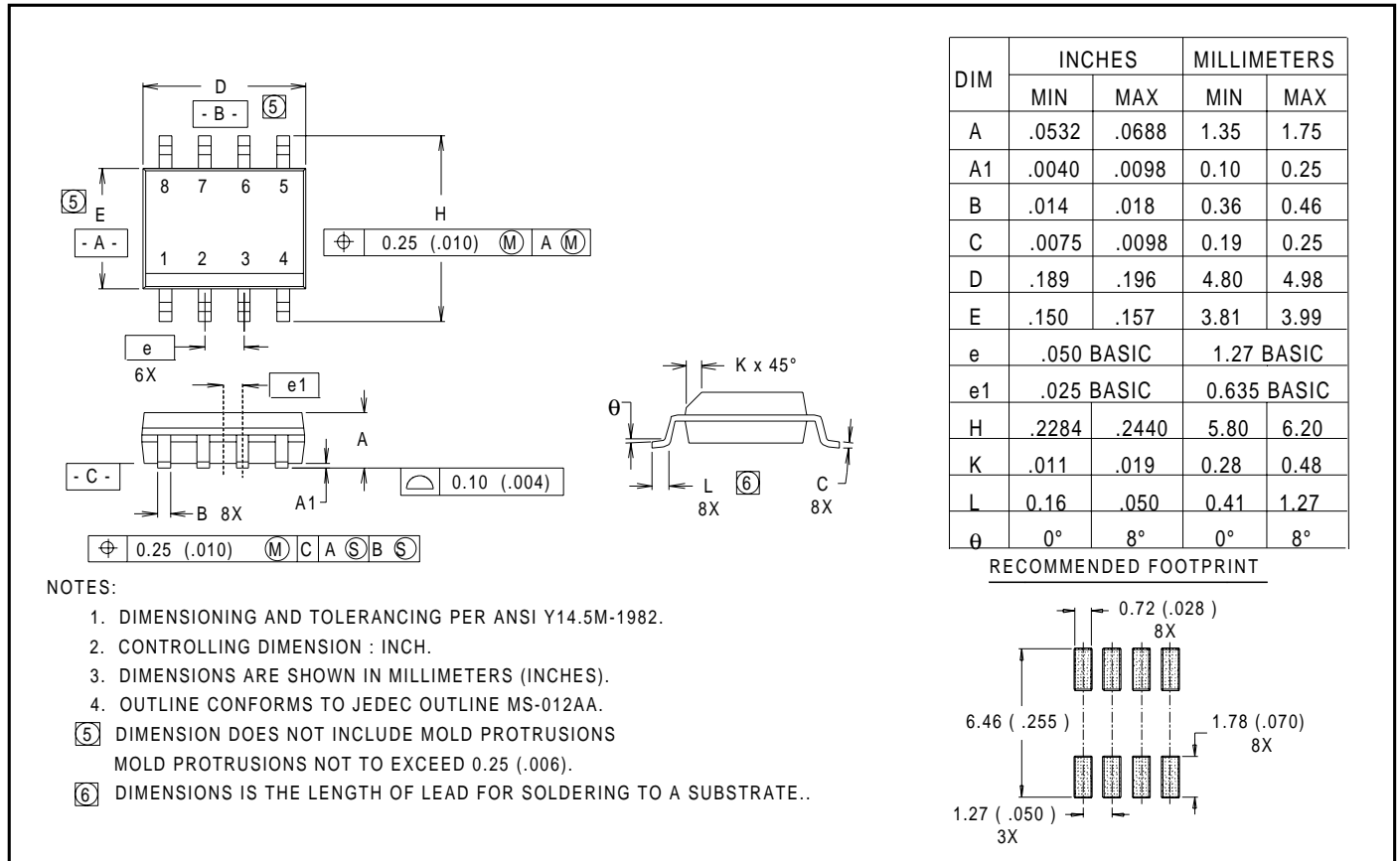

Fig 11. Maximum Effective Transient Thermal Impedance, Junction-to-Ambient

Package Outline

SO8 Outline



Part Marking Information

SO8

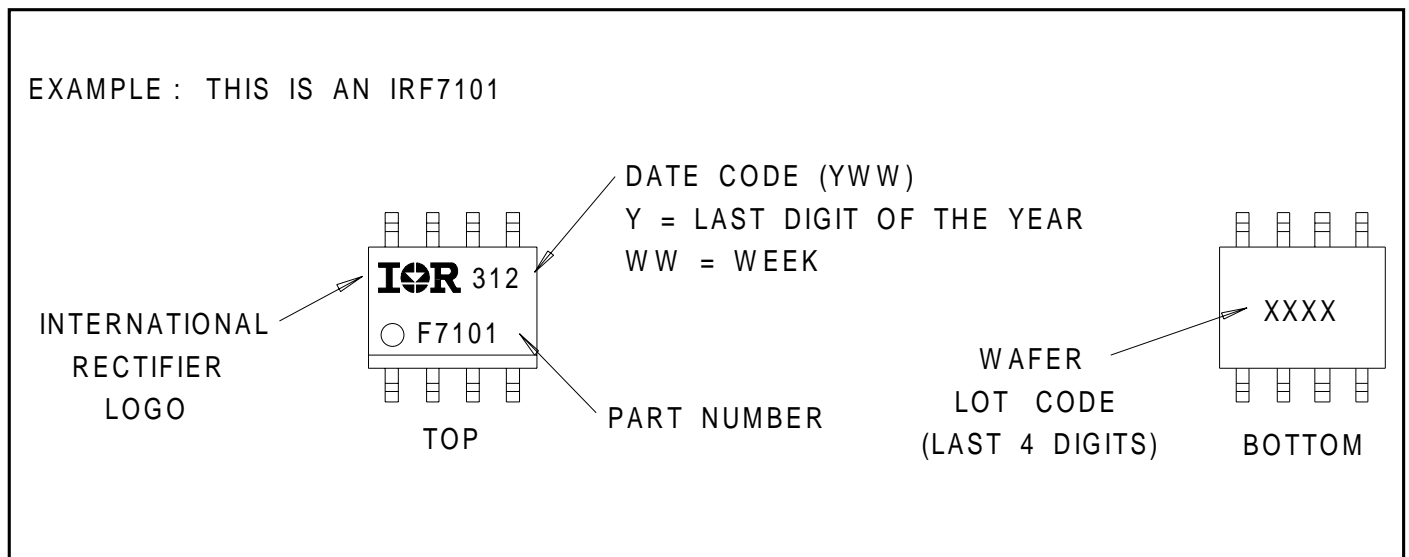

Tape & Reel Information

S08

Dimensions are shown in millimeters (inches)

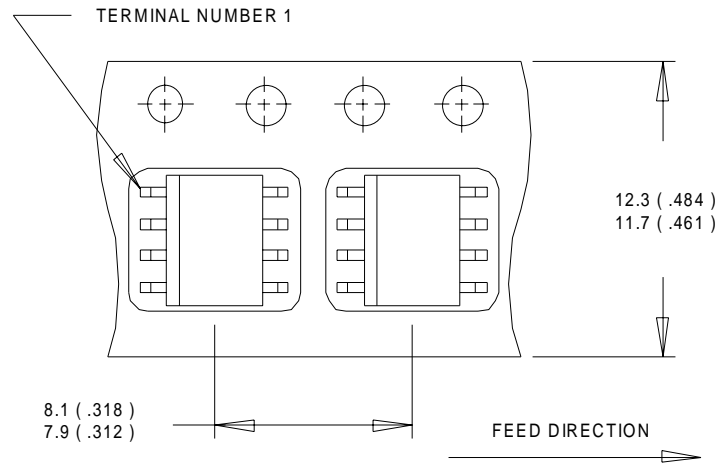

NOTES:

1. CONTROLLING DIMENSION : MILLIMETER.
2. ALL DIMENSIONS ARE SHOWN IN MILLIMETERS(INCHES).
3. OUTLINE CONFORMS TO EIA-481 & EIA-541.

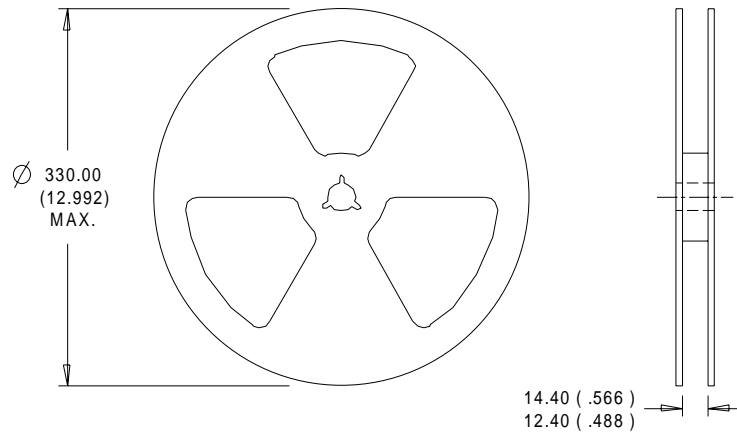

NOTES :

1. CONTROLLING DIMENSION : MILLIMETER.
2. OUTLINE CONFORMS TO EIA-481 & EIA-541.