

- N-Channel Application-Specific MOSFETs
- Ideal for CPU Core DC-DC Converters
- Low Conduction Losses
- Low Switching Losses
- Minimizes Parallel MOSFETs for high current applications
- 100% R<sub>G</sub> Tested

**Description**

This new device employs advanced HEXFET Power MOSFET technology to achieve an unprecedented balance of on-resistance and gate charge. The reduced conduction and switching losses make it ideal for high efficiency DC-DC converters that power the latest generation of microprocessors.

The IRF7811AV has been optimized for all parameters that are critical in synchronous buck converters including R<sub>DS(on)</sub>, gate charge and Cdv/dt-induced turn-on immunity. The IRF7811AV offers an extremely low combination of Q<sub>sw</sub> & R<sub>DS(on)</sub> for reduced losses in both control and synchronous FET applications.

The package is designed for vapor phase, infra-red, convection, or wave soldering techniques. Power dissipation of greater than 2W is possible in a typical PCB mount application.

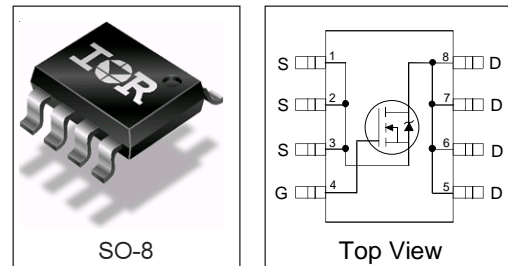

**DEVICE CHARACTERISTICS** ⑤

	<b>IRF7811AV</b>
R <sub>DS(on)</sub>	11 mΩ
Q <sub>G</sub>	17 nC
Q <sub>sw</sub>	6.7 nC
Q <sub>oss</sub>	8.1 nC

**Absolute Maximum Ratings**

Parameter	Symbol	IRF7811AV	Units
Drain-to-Source Voltage	V <sub>DS</sub>	30	V
Gate-to-Source Voltage	V <sub>GS</sub>	±20	
Continuous Output Current (V <sub>GS</sub> ≥ 4.5V)	T <sub>A</sub> = 25°C	10.8	A
	T <sub>L</sub> = 90°C	11.8	
Pulsed Drain Current ①	I <sub>DM</sub>	100	
Power Dissipation ③	T <sub>A</sub> = 25°C	2.5	W
	T <sub>L</sub> = 90°C	3.0	
Junction & Storage Temperature Range	T <sub>J</sub> , T <sub>STG</sub>	-55 to 150	°C
Continuous Source Current (Body Diode)	I <sub>S</sub>	2.5	A
Pulsed Source Current ①	I <sub>SM</sub>	50	

**Thermal Resistance**

Parameter	Symbol	Typ	Max	Units
Maximum Junction-to-Ambient ③⑥	R <sub>θJA</sub>	---	50	°C/W
Maximum Junction-to-Lead ⑥	R <sub>θJL</sub>	---	20	

## Electrical Characteristics

Parameter	Symbol	Min	Typ	Max	Units	Conditions
Drain-to-Source Breakdown Voltage	$V_{(BR)DSS}$	30	—	—	V	$V_{GS} = 0V, I_D = 250\mu A$
Static Drain-to-Source On-Resistance	$R_{DS(on)}$	—	11	14	m $\Omega$	$V_{GS} = 4.5V, I_D = 15A$ ②
Gate Threshold Voltage	$V_{GS(th)}$	1.0	—	3.0	V	$V_{DS} = V_{GS}, I_D = 250\mu A$
Drain-to-Source Leakage Current	$I_{DSS}$	—	—	50	$\mu A$	$V_{DS} = 30V, V_{GS} = 0V$
		—	—	20	$\mu A$	$V_{DS} = 24V, V_{GS} = 0V$
		—	—	100	$\mu A$	$V_{DS} = 24V, V_{GS} = 0V, T_J = 100^\circ C$
Gate-to-Source Leakage Current	$I_{GSS}$	—	—	$\pm 100$	nA	$V_{GS} = \pm 20V$
Total Gate Charge, Control FET	$Q_g$	—	17	26	nC	$V_{DS} = 24V, I_D = 15A, V_{GS} = 5.0V$ $V_{GS} = 5.0V, V_{DS} < 100mV$ $V_{DS} = 16V, I_D = 15A$
Total Gate Charge, Synch FET	$Q_g$	—	14	21		
Pre-V <sub>th</sub> Gate-to-Source Charge	$Q_{gs1}$	—	3.4	—		
Post-V <sub>th</sub> Gate-to-Source Charge	$Q_{gs2}$	—	1.6	—		
Gate-to-Drain ("Miller") Charge	$Q_{gd}$	—	5.1	—		
Switch Charge ( $Q_{gs2} + Q_{gd}$ )	$Q_{SW}$	—	6.7	—		
Output Charge	$Q_{OSS}$	—	8.1	12		
Gate Resistance	$R_G$	0.5	—	4.4	$\Omega$	
Turn-On Delay Time	$t_{d(on)}$	—	8.6	—	ns	$V_{DD} = 16V$ $I_D = 15A$ $V_{GS} = 5.0V$ Clamped Inductive Load
Rise Time	$t_r$	—	21	—		
Turn-Off Delay Time	$t_{d(off)}$	—	43	—		
Fall Time	$t_f$	—	10	—		
Input Capacitance	$C_{iss}$	—	1801	—	pF	$V_{GS} = 0V$ $V_{DS} = 10V$
Output Capacitance	$C_{oss}$	—	723	—		
Reverse Transfer Capacitance	$C_{rss}$	—	46	—		

## Diode Characteristics

Parameter	Symbol	Min	Typ	Max	Units	Conditions
Diode Forward Voltage	$V_{SD}$	—	—	1.3	V	$T_J = 25^\circ C, I_S = 15A$ ②, $V_{GS} = 0V$
Reverse Recovery Charge ④	$Q_{rr}$	—	50	—	nC	$di/dt = 700A/\mu s$ $V_{DD} = 16V, V_{GS} = 0V, I_D = 15A$
Reverse Recovery Charge (with Parallel Schottky) ④	$Q_{rr}$	—	43	—	nC	$di/dt = 700A/\mu s$ , (with 10BQ040) $V_{DD} = 16V, V_{GS} = 0V, I_D = 15A$

### Notes:

- ① Repetitive rating; pulse width limited by max. junction temperature.
- ② Pulse width  $\leq 400 \mu s$ ; duty cycle  $\leq 2\%$ .
- ③ When mounted on 1 inch square copper board,  $t < 10$  sec.
- ④ Typ = measured -  $Q_{oss}$
- ⑤ Typical values of  $R_{DS(on)}$  measured at  $V_{GS} = 4.5V$ ,  $Q_g$ ,  $Q_{SW}$  and  $Q_{OSS}$  measured at  $V_{GS} = 5.0V$ ,  $I_F = 15A$ .
- ⑥  $R_{\theta}$  is measured at  $T_J$  approximately  $90^\circ C$

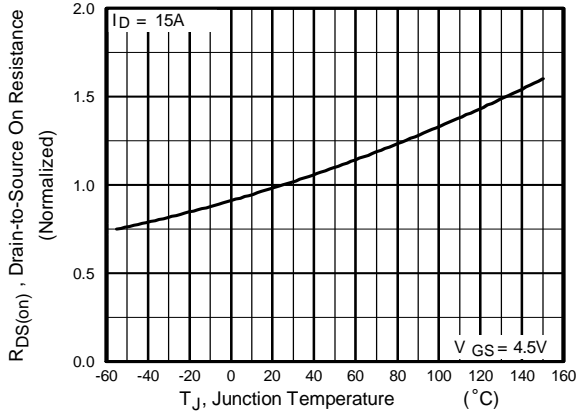

Figure 1. Normalized On-Resistance vs. Temperature

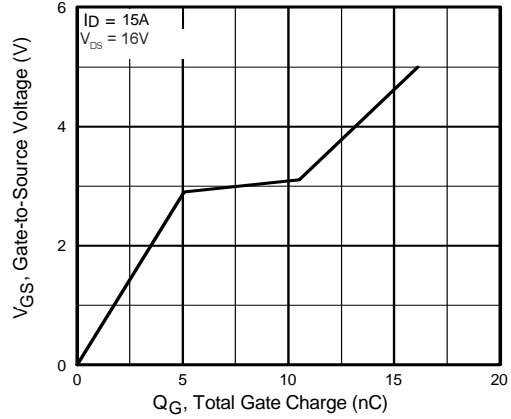

Figure 2. Gate-to-Source Voltage vs. Typical Gate Charge

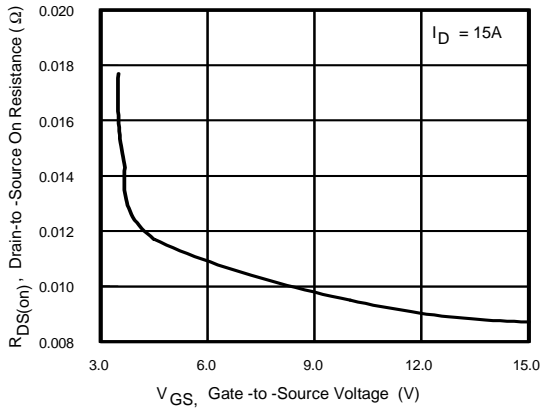

Figure 3. Typical  $R_{DS(on)}$  vs. Gate-to-Source Voltage

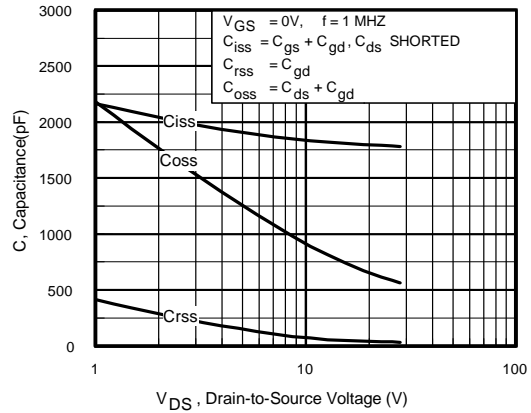

Figure 4. Typical Capacitance vs. Drain-to-Source Voltage

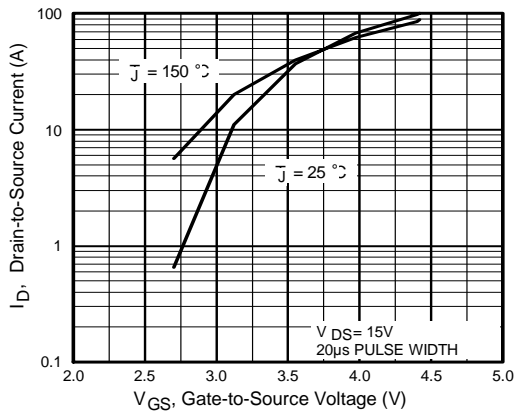

Figure 5. Typical Transfer Characteristics

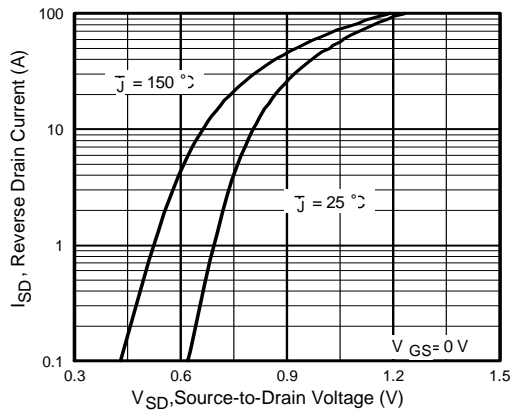

Figure 6. Typical Source-Drain Diode Forward Voltage

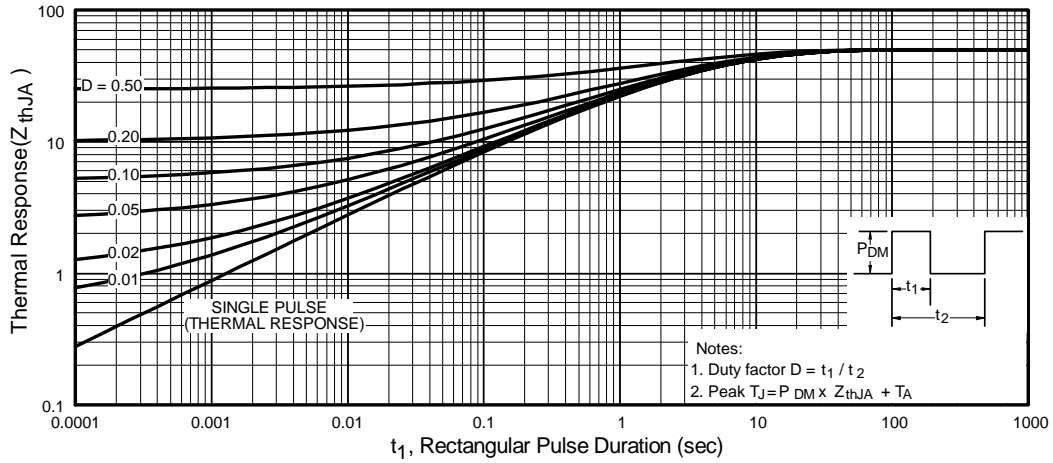

Figure 7. Maximum Effective Transient Thermal Impedance, Junction-to-Ambient

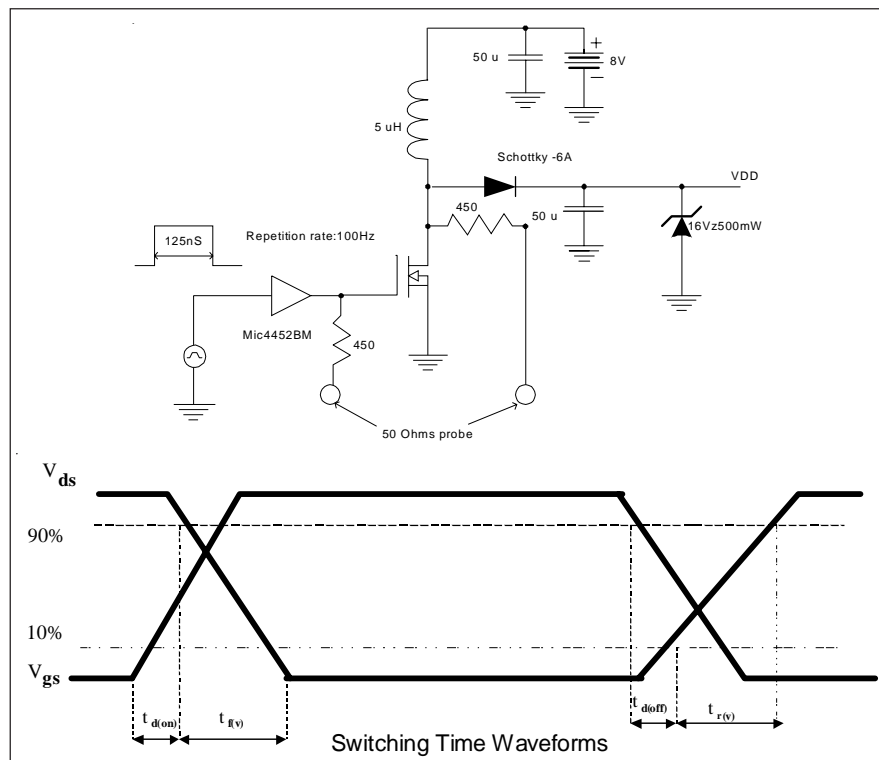
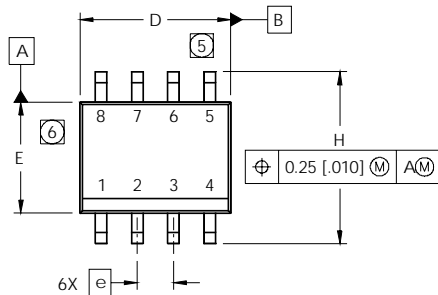

Figure 8. Clamped Inductive load test diagram and switching waveform

## SO-8 Package Outline

Dimensions are shown in millimeters (inches)



DIM	INCHES		MILLIMETERS	
	MIN	MAX	MIN	MAX
A	.0532	.0688	1.35	1.75
A1	.0040	.0098	0.10	0.25
b	.013	.020	0.33	0.51
c	.0075	.0098	0.19	0.25
D	.189	.1968	4.80	5.00
E	.1497	.1574	3.80	4.00
e	.050 BASIC		1.27 BASIC	
e1	.025 BASIC		0.635 BASIC	
H	.2284	.2440	5.80	6.20
K	.0099	.0196	0.25	0.50
L	.016	.050	0.40	1.27
y	0°	8°	0°	8°

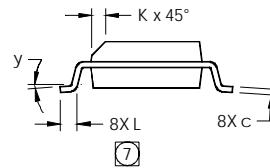
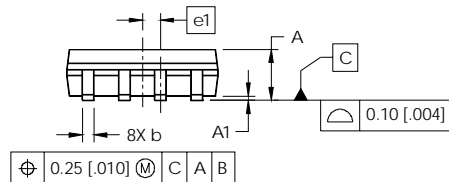

NOTES:

- DIMENSIONING & TOLERANCING PER ASME Y14.5M-1994.
- CONTROLLING DIMENSION: MILLIMETER
- DIMENSIONS ARE SHOWN IN MILLIMETERS [INCHES].
- OUTLINE CONFORMS TO JEDEC OUTLINE MS-012AA
- (5) DIMENSION DOES NOT INCLUDE MOLD PROTRUSIONS. MOLD PROTRUSIONS NOT TO EXCEED 0.15 [0.006].
- (6) DIMENSION DOES NOT INCLUDE MOLD PROTRUSIONS. MOLD PROTRUSIONS NOT TO EXCEED 0.25 [0.010].
- (7) DIMENSION IS THE LENGTH OF LEAD FOR SOLDERING TO A SUBSTRATE.

FOOTPRINT

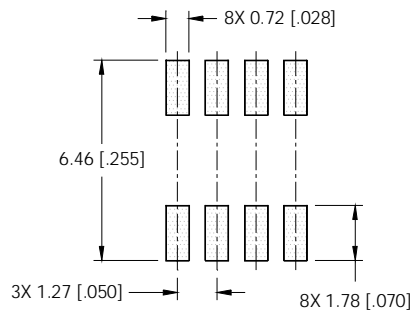

## SO-8 Part Marking

EXAMPLE: THIS IS AN IRF7101 (MOSFET)

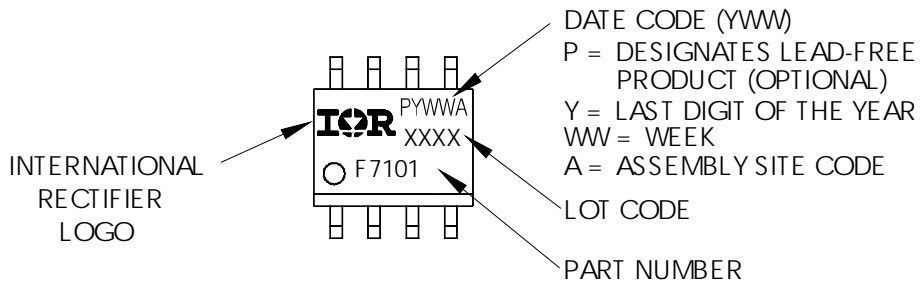

# IRF7811AV

International  
**IR** Rectifier

## SO-8 Tape and Reel

Dimensions are shown in millimeters (inches)

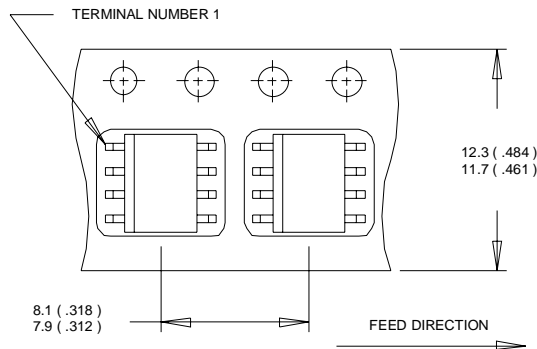

### NOTES:

1. CONTROLLING DIMENSION : MILLIMETER.
2. ALL DIMENSIONS ARE SHOWN IN MILLIMETERS(INCHES).
3. OUTLINE CONFORMS TO EIA-481 & EIA-541.

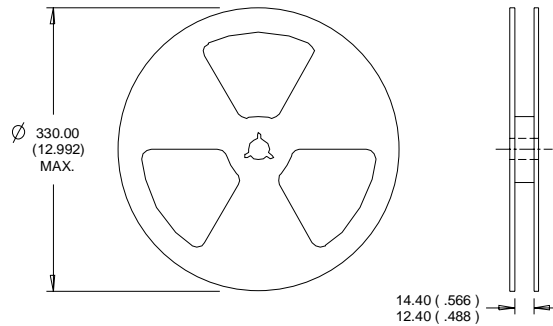

### NOTES :

1. CONTROLLING DIMENSION : MILLIMETER.
2. OUTLINE CONFORMS TO EIA-481 & EIA-541.

Data and specifications subject to change without notice.  
This product has been designed and qualified for the industrial market.  
Qualification Standards can be found on IR's Web site.

International  
**IR** Rectifier