

IRLI3705N

HEXFET[®] Power MOSFET

- Logic-Level Gate Drive
- Advanced Process Technology
- Isolated Package
- High Voltage Isolation = 2.5KVRMS ⑤
- Sink to Lead Creepage Dist. = 4.8mm
- Fully Avalanche Rated

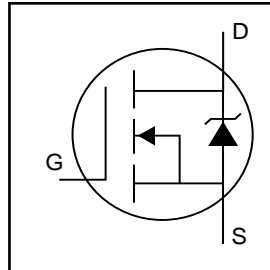

$V_{DSS} = 55V$
$R_{DS(on)} = 0.01\Omega$
$I_D = 52A$

Description

Fifth Generation HEXFETs from International Rectifier utilize advanced processing techniques to achieve extremely low on-resistance per silicon area. This benefit, combined with the fast switching speed and ruggedized device design that HEXFET Power MOSFETs are well known for, provides the designer with an extremely efficient and reliable device for use in a wide variety of applications.

The TO-220 Fullpak eliminates the need for additional insulating hardware in commercial-industrial applications. The moulding compound used provides a high isolation capability and a low thermal resistance between the tab and external heatsink. This isolation is equivalent to using a 100 micron mica barrier with standard TO-220 product. The Fullpak is mounted to a heatsink using a single clip or by a single screw fixing.

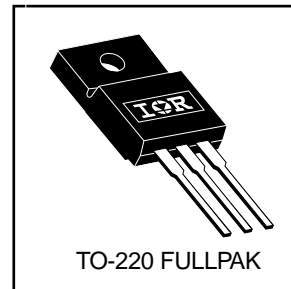

Absolute Maximum Ratings

	Parameter	Max.	Units
$I_D @ T_C = 25^\circ C$	Continuous Drain Current, $V_{GS} @ 10V$	52	A
$I_D @ T_C = 100^\circ C$	Continuous Drain Current, $V_{GS} @ 10V$	37	
I_{DM}	Pulsed Drain Current ①⑥	310	
$P_D @ T_C = 25^\circ C$	Power Dissipation	58	W
	Linear Derating Factor	0.39	W/°C
V_{GS}	Gate-to-Source Voltage	± 16	V
E_{AS}	Single Pulse Avalanche Energy②⑥	340	mJ
I_{AR}	Avalanche Current①⑥	46	A
E_{AR}	Repetitive Avalanche Energy①	5.8	mJ
dv/dt	Peak Diode Recovery dv/dt ③⑥	5.0	V/ns
T_J	Operating Junction and	-55 to + 175	°C
T_{STG}	Storage Temperature Range		
	Soldering Temperature, for 10 seconds		
	Mounting torque, 6-32 or M3 screw	10 lbf•in (1.1N•m)	

Thermal Resistance

	Parameter	Typ.	Max.	Units
$R_{\theta JC}$	Junction-to-Case	—	2.6	°C/W
$R_{\theta JA}$	Junction-to-Ambient	—	65	

Electrical Characteristics @ T_J = 25°C (unless otherwise specified)

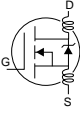
	Parameter	Min.	Typ.	Max.	Units	Conditions
V _{(BR)DSS}	Drain-to-Source Breakdown Voltage	55	—	—	V	V _{GS} = 0V, I _D = 250μA
ΔV _{(BR)DSS/ΔT_J}	Breakdown Voltage Temp. Coefficient	—	0.056	—	V/°C	Reference to 25°C, I _D = 1mA ^⑥
R _{DS(on)}	Static Drain-to-Source On-Resistance	—	—	0.010	Ω	V _{GS} = 10V, I _D = 28A ^④
		—	—	0.012		V _{GS} = 5.0V, I _D = 28A ^④
		—	—	0.018		V _{GS} = 4.0V, I _D = 24A ^④
V _{GS(th)}	Gate Threshold Voltage	1.0	—	2.0	V	V _{DS} = V _{GS} , I _D = 250μA
g _{fs}	Forward Transconductance	50	—	—	S	V _{DS} = 25V, I _D = 46A ^⑥
I _{DSS}	Drain-to-Source Leakage Current	—	—	25	μA	V _{DS} = 55V, V _{GS} = 0V
		—	—	250		V _{DS} = 44V, V _{GS} = 0V, T _J = 150°C
I _{GSS}	Gate-to-Source Forward Leakage	—	—	100	nA	V _{GS} = 16V
	Gate-to-Source Reverse Leakage	—	—	-100		V _{GS} = -16V
Q _g	Total Gate Charge	—	—	98	nC	I _D = 46A
Q _{gs}	Gate-to-Source Charge	—	—	19		V _{DS} = 44V
Q _{gd}	Gate-to-Drain ("Miller") Charge	—	—	49		V _{GS} = 5.0V, See Fig. 6 and 13 ^{④⑥}
t _{d(on)}	Turn-On Delay Time	—	12	—		V _{DD} = 28V
t _r	Rise Time	—	140	—	ns	I _D = 46A
t _{d(off)}	Turn-Off Delay Time	—	37	—		R _G = 1.8Ω, V _{GS} = 5.0V
t _f	Fall Time	—	78	—		R _D = 0.59Ω, See Fig. 10 ^{④⑥}
L _D	Internal Drain Inductance	—	4.5	—	nH	Between lead, 6mm (0.25in.) from package and center of die contact
L _S	Internal Source Inductance	—	7.5	—		
C _{iss}	Input Capacitance	—	3600	—	pF	V _{GS} = 0V
C _{oss}	Output Capacitance	—	870	—		V _{DS} = 25V
C _{rss}	Reverse Transfer Capacitance	—	320	—		f = 1.0MHz, See Fig. 5 ^⑥
C	Drain to Sink Capacitance	—	12	—		f = 1.0MHz

Source-Drain Ratings and Characteristics

	Parameter	Min.	Typ.	Max.	Units	Conditions
I _S	Continuous Source Current (Body Diode)	—	—	52	A	MOSFET symbol showing the integral reverse p-n junction diode.
I _{SM}	Pulsed Source Current (Body Diode) ^{①⑥}	—	—	310		
V _{SD}	Diode Forward Voltage	—	—	1.3	V	T _J = 25°C, I _S = 28A, V _{GS} = 0V ^④
t _{rr}	Reverse Recovery Time	—	94	140	ns	T _J = 25°C, I _F = 46A
Q _{rr}	Reverse Recovery Charge	—	290	440	nC	di/dt = 100A/μs ^{④⑥}

Notes:

- ① Repetitive rating; pulse width limited by max. junction temperature. (See fig. 11)
- ② V_{DD} = 25V, starting T_J = 25°C, L = 320μH
R_G = 25Ω, I_{AS} = 46A. (See Figure 12)
- ③ I_{SD} ≤ 46A, di/dt ≤ 250A/μs, V_{DD} ≤ V_{(BR)DSS},
T_J ≤ 175°C
- ④ Pulse width ≤ 300μs; duty cycle ≤ 2%.
- ⑤ t=60s, f=60Hz ⑥ Uses IRL3705N data and test conditions

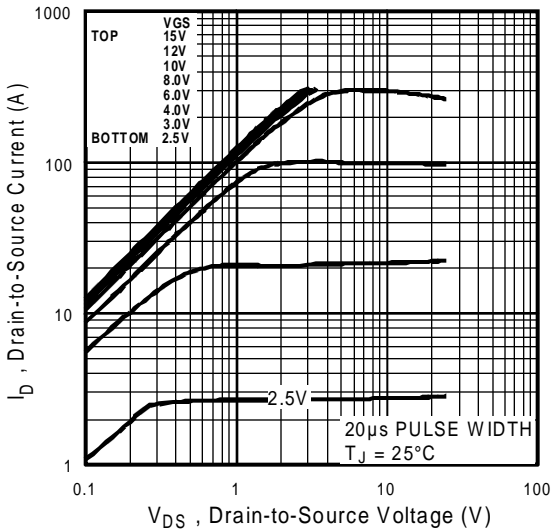

Fig 1. Typical Output Characteristics

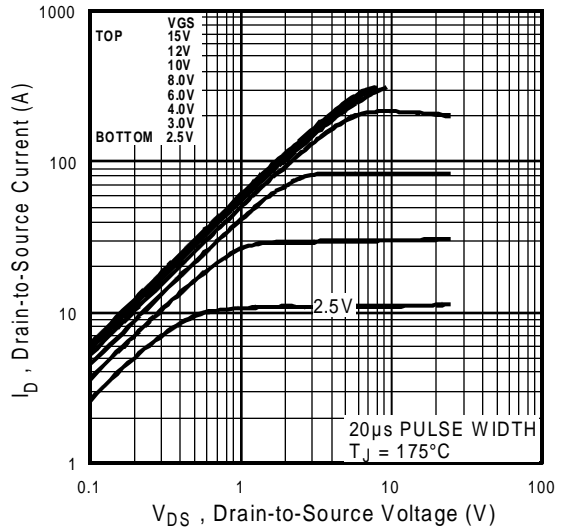

Fig 2. Typical Output Characteristics

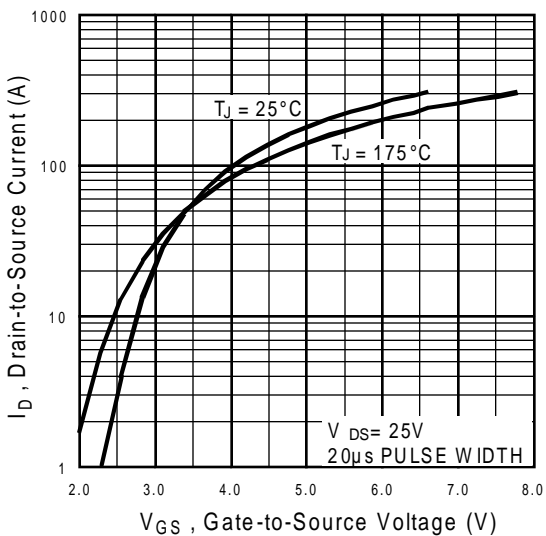

Fig 3. Typical Transfer Characteristics

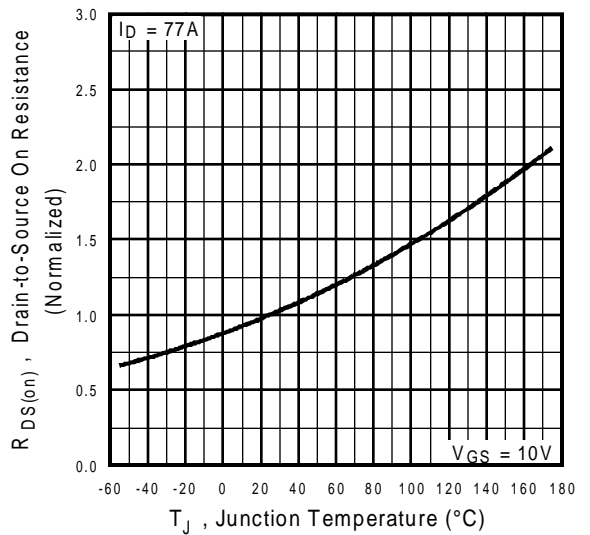

Fig 4. Normalized On-Resistance Vs. Temperature

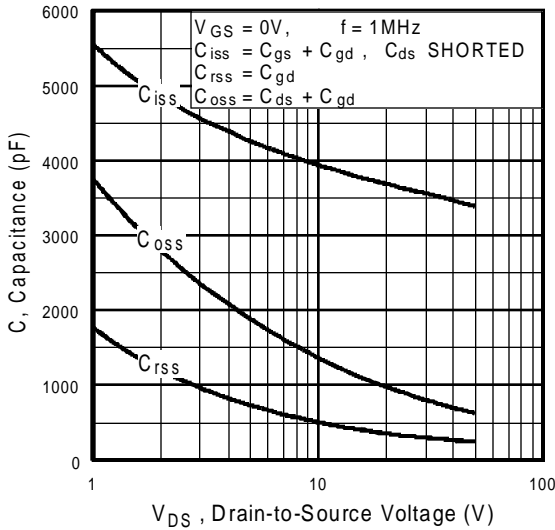

Fig 5. Typical Capacitance Vs. Drain-to-Source Voltage

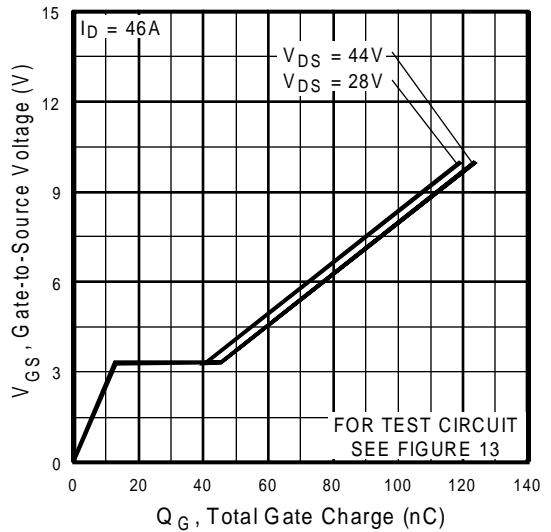

Fig 6. Typical Gate Charge Vs. Gate-to-Source Voltage

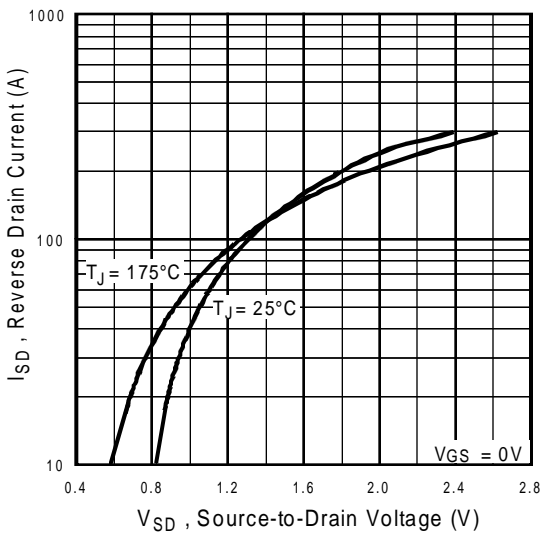

Fig 7. Typical Source-Drain Diode Forward Voltage

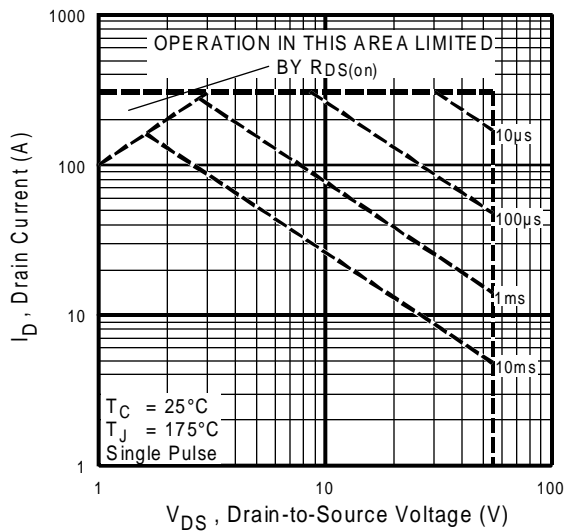

Fig 8. Maximum Safe Operating Area

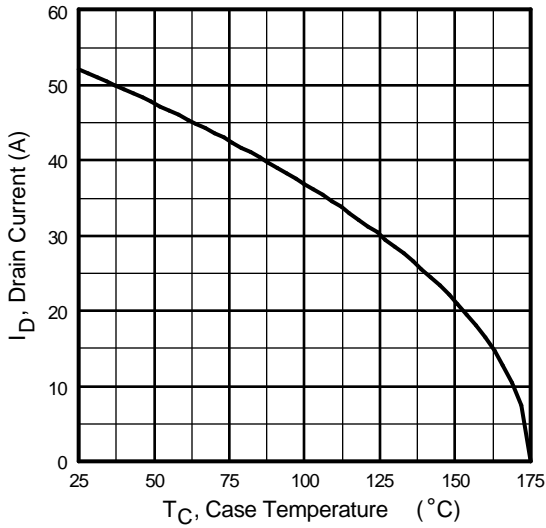

Fig 9. Maximum Drain Current Vs. Case Temperature

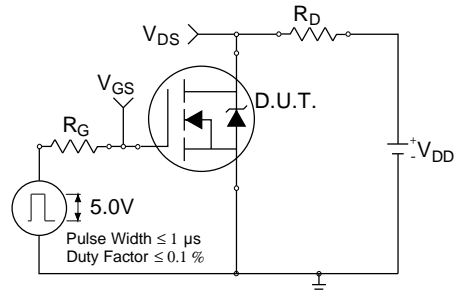

Fig 10a. Switching Time Test Circuit

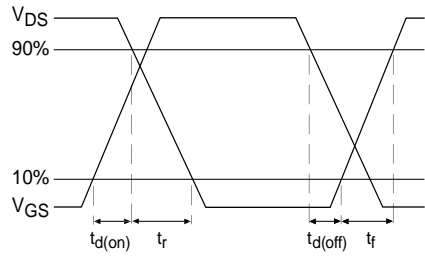

Fig 10b. Switching Time Waveforms

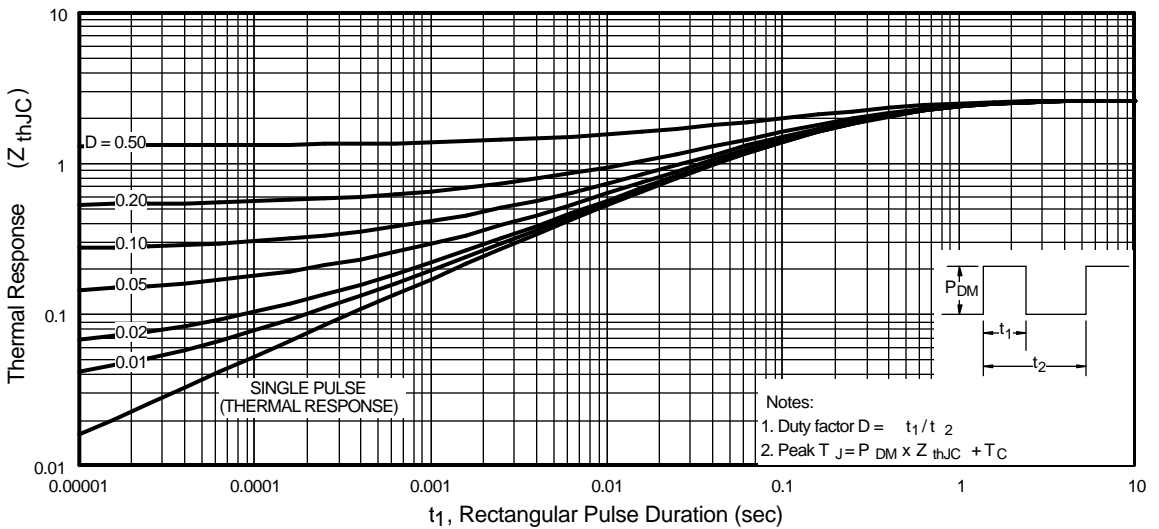

Fig 11. Maximum Effective Transient Thermal Impedance, Junction-to-Case

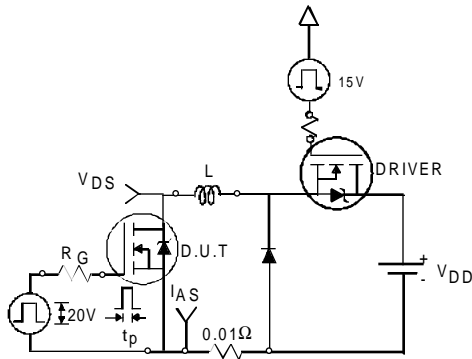

Fig 12a. Unclamped Inductive Test Circuit

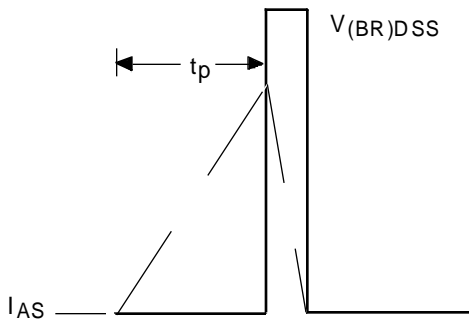

Fig 12b. Unclamped Inductive Waveforms

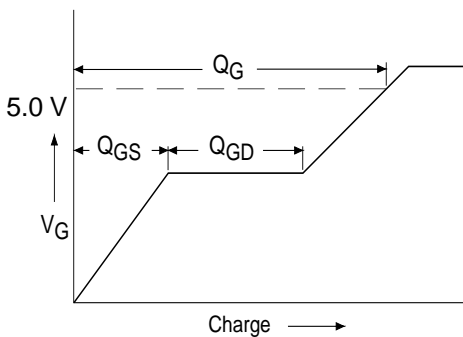

Fig 13a. Basic Gate Charge Waveform

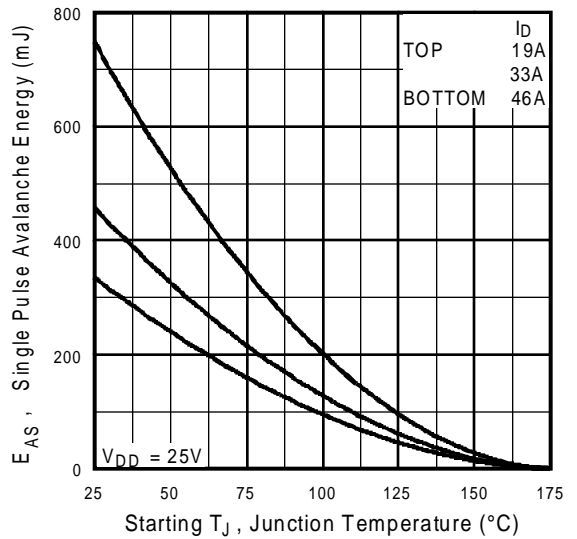

Fig 12c. Maximum Avalanche Energy Vs. Drain Current

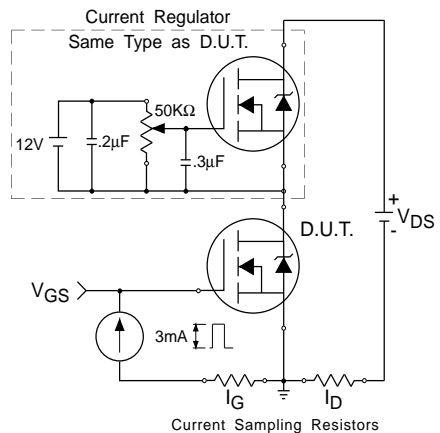
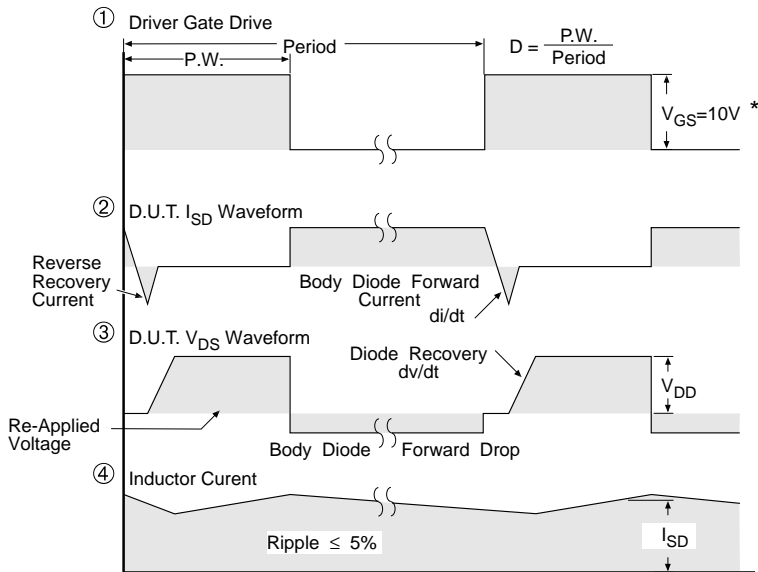
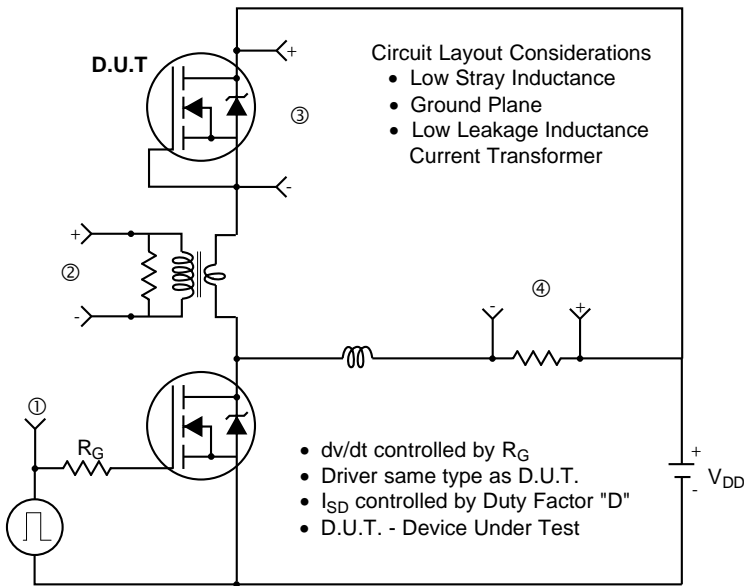

Fig 13b. Gate Charge Test Circuit

Peak Diode Recovery dv/dt Test Circuit



* $V_{GS} = 5V$ for Logic Level Devices

Fig 14. For N-Channel HEXFETS

Package Outline

TO-220 Fullpak Outline

Dimensions are shown in millimeters (inches)

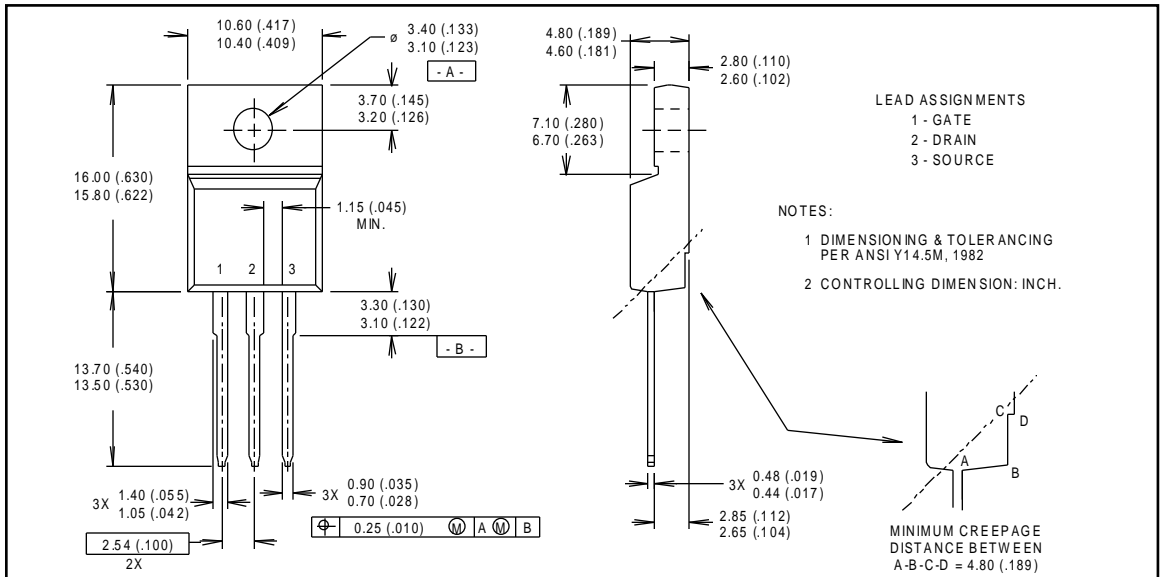

Part Marking Information

TO-220 Fullpak

EXAMPLE : THIS IS AN IRF1840G
WITH ASSEMBLY
LOT CODE E401

