

MMBT2907AL, SMMBT2907AL

General Purpose Transistors

PNP Silicon

Features

- These Devices are Pb-Free, Halogen Free/BFR Free and are RoHS Compliant
- S Prefix for Automotive and Other Applications Requiring Unique Site and Control Change Requirements; AEC-Q101 Qualified and PPAP Capable

MAXIMUM RATINGS

Rating	Symbol	Value	Unit
Collector - Emitter Voltage	V_{CEO}	-60	Vdc
Collector - Base Voltage	V_{CBO}	-60	Vdc
Emitter - Base Voltage	V_{EBO}	-5.0	Vdc
Collector Current - Continuous	I_C	-600	mAdc
Collector Current - Peak (Note 3)	I_{CM}	-1200	mAdc

THERMAL CHARACTERISTICS

Characteristic	Symbol	Max	Unit
Total Device Dissipation - FR-5 Board (Note 1) @ $T_A = 25^\circ\text{C}$ Derate above 25°C	P_D	225 1.8	mW mW/ $^\circ\text{C}$
Thermal Resistance, Junction-to-Ambient	$R_{\theta JA}$	556	$^\circ\text{C}/\text{W}$
Total Device Dissipation - Alumina Substrate, (Note 2) @ $T_A = 25^\circ\text{C}$ Derate above 25°C	P_D	300 2.4	mW mW/ $^\circ\text{C}$
Thermal Resistance, Junction-to-Ambient	$R_{\theta JA}$	417	$^\circ\text{C}/\text{W}$
Total Device Dissipation - Heat Spreader or equivalent, (Note 4) @ $T_A = 25^\circ\text{C}$	P_D	350	mW
Thermal Resistance, Junction-to-Ambient	$R_{\theta JA}$	357	$^\circ\text{C}/\text{W}$
Junction and Storage Temperature	T_J, T_{stg}	-55 to +150	$^\circ\text{C}$

Stresses exceeding Maximum Ratings may damage the device. Maximum Ratings are stress ratings only. Functional operation above the Recommended Operating Conditions is not implied. Extended exposure to stresses above the Recommended Operating Conditions may affect device reliability.

1. FR-5 = $1.0 \times 0.75 \times 0.062$ in.
2. Alumina = $0.4 \times 0.3 \times 0.024$ in. 99.5% alumina.
3. Reference SOA curve.
4. Heat Spreader or equivalent = 450 mm^2 , 2 oz.



ON Semiconductor®

<http://onsemi.com>

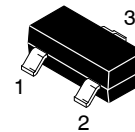
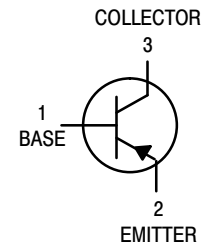

SOT-23 (TO-236AB)
CASE 318
STYLE 6

MARKING DIAGRAM

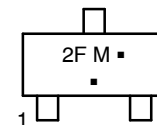

2F = Device Code
M = Date Code*
■ = Pb-Free Package

(Note: Microdot may be in either location)

*Date Code orientation and/or overbar may vary depending upon manufacturing location.

ORDERING INFORMATION

Device	Package	Shipping†
MMBT2907ALT1G SMMBT2907ALT1G	SOT-23 (Pb-Free)	3000 / Tape & Reel
MMBT2907ALT3G SMMBT2907ALT3G	SOT-23 (Pb-Free)	10,000 / Tape & Reel

†For information on tape and reel specifications, including part orientation and tape sizes, please refer to our Tape and Reel Packaging Specifications Brochure, BRD8011/D.

MMBT2907AL, SMMBT2907AL

ELECTRICAL CHARACTERISTICS ($T_A = 25^\circ\text{C}$ unless otherwise noted)

Characteristic	Symbol	Min	Max	Unit
OFF CHARACTERISTICS				
Collector-Emitter Breakdown Voltage (Note 5) ($I_C = -1.0\text{ mAdc}$, $I_B = 0$) ($I_C = -10\text{ mAdc}$, $I_B = 0$)	$V_{(BR)CEO}$	-60 -60	-	Vdc
Collector-Base Breakdown Voltage ($I_C = -10\text{ }\mu\text{Adc}$, $I_E = 0$)	$V_{(BR)CBO}$	-60	-	Vdc
Emitter-Base Breakdown Voltage ($I_E = -10\text{ }\mu\text{Adc}$, $I_C = 0$)	$V_{(BR)EBO}$	-5.0	-	Vdc
Collector Cutoff Current ($V_{CE} = -30\text{ Vdc}$, $V_{EB(off)} = -0.5\text{ Vdc}$)	I_{CEX}	-	-50	nAdc
Collector Cutoff Current ($V_{CB} = -50\text{ Vdc}$, $I_E = 0$) ($V_{CB} = -50\text{ Vdc}$, $I_E = 0$, $T_A = 125^\circ\text{C}$)	I_{CBO}	-	-0.010 -10	μAdc
Base Cutoff Current ($V_{CE} = -30\text{ Vdc}$, $V_{EB(off)} = -0.5\text{ Vdc}$)	I_{BL}	-	-50	nAdc

ON CHARACTERISTICS

DC Current Gain ($I_C = -0.1\text{ mAdc}$, $V_{CE} = -10\text{ Vdc}$) ($I_C = -1.0\text{ mAdc}$, $V_{CE} = -10\text{ Vdc}$) ($I_C = -10\text{ mAdc}$, $V_{CE} = -10\text{ Vdc}$) ($I_C = -150\text{ mAdc}$, $V_{CE} = -10\text{ Vdc}$) ($I_C = -500\text{ mAdc}$, $V_{CE} = -10\text{ Vdc}$) (Note 5)	h_{FE}	75 100 100 100 50	-	-
Collector-Emitter Saturation Voltage (Note 5) ($I_C = -150\text{ mAdc}$, $I_B = -15\text{ mAdc}$) (Note 5) ($I_C = -500\text{ mAdc}$, $I_B = -50\text{ mAdc}$)	$V_{CE(sat)}$	-	-0.4 -1.6	Vdc
Base-Emitter Saturation Voltage (Note 5) ($I_C = -150\text{ mAdc}$, $I_B = -15\text{ mAdc}$) ($I_C = -500\text{ mAdc}$, $I_B = -50\text{ mAdc}$)	$V_{BE(sat)}$	-	-1.3 -2.6	Vdc

SMALL-SIGNAL CHARACTERISTICS

Current-Gain - Bandwidth Product (Notes 5, 6), ($I_C = -50\text{ mAdc}$, $V_{CE} = -20\text{ Vdc}$, $f = 100\text{ MHz}$)	f_T	200	-	MHz
Output Capacitance ($V_{CB} = -10\text{ Vdc}$, $I_E = 0$, $f = 1.0\text{ MHz}$)	C_{obo}	-	8.0	pF
Input Capacitance ($V_{EB} = -2.0\text{ Vdc}$, $I_C = 0$, $f = 1.0\text{ MHz}$)	C_{ibo}	-	30	pF

SWITCHING CHARACTERISTICS

Turn-On Time	$(V_{CC} = -30\text{ Vdc}$, $I_C = -150\text{ mAdc}$, $I_{B1} = -15\text{ mAdc}$)	t_{on}	-	45	ns
Delay Time		t_d	-	10	
Rise Time		t_r	-	40	
Turn-Off Time	$(V_{CC} = -6.0\text{ Vdc}$, $I_C = -150\text{ mAdc}$, $I_{B1} = I_{B2} = -15\text{ mAdc}$)	t_{off}	-	100	
Storage Time		t_s	-	80	
Fall Time		t_f	-	30	

5. Pulse Test: Pulse Width $\leq 300\text{ }\mu\text{s}$, Duty Cycle $\leq 2.0\%$.
6. f_T is defined as the frequency at which $|h_{fe}|$ extrapolates to unity.

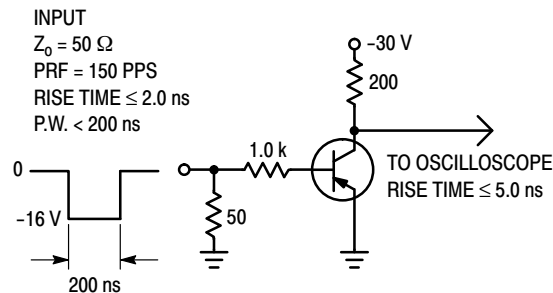

Figure 1. Delay and Rise Time Test Circuit

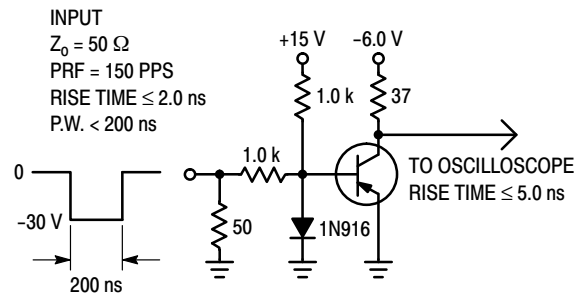

Figure 2. Storage and Fall Time Test Circuit

MMBT2907AL, SMMBT2907AL

TYPICAL CHARACTERISTICS

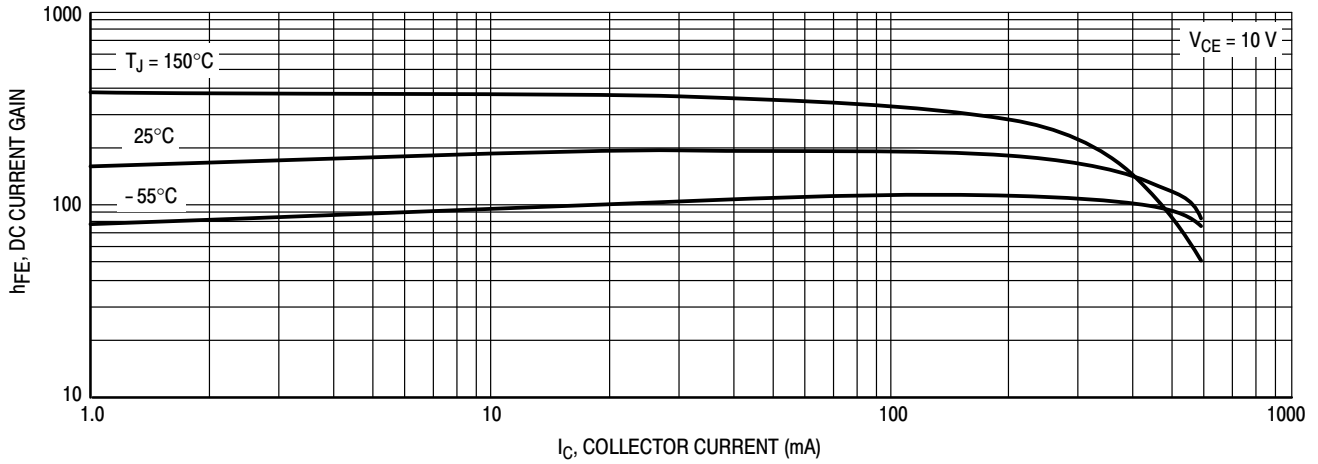

Figure 3. DC Current Gain

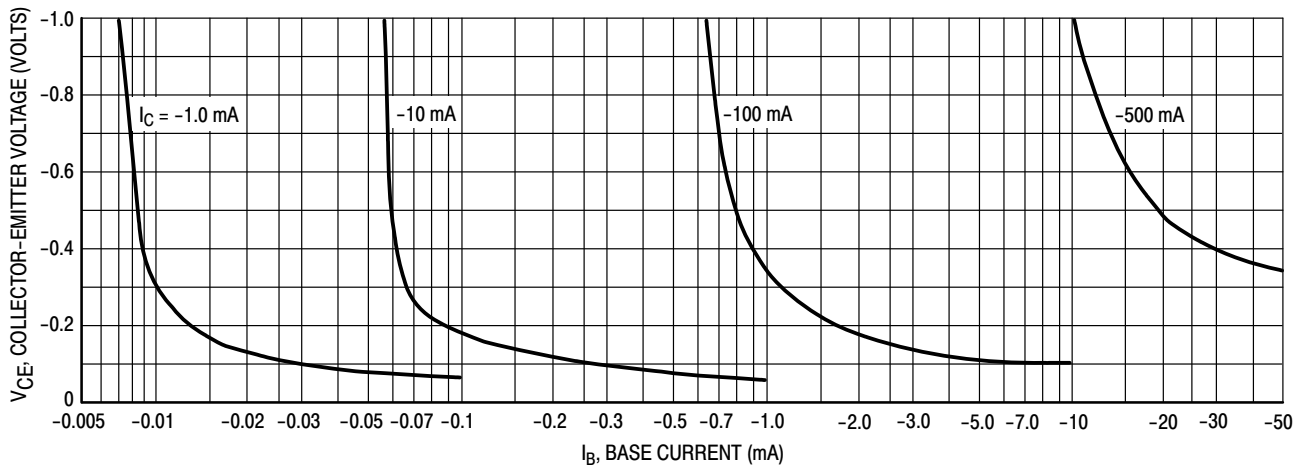

Figure 4. Collector Saturation Region

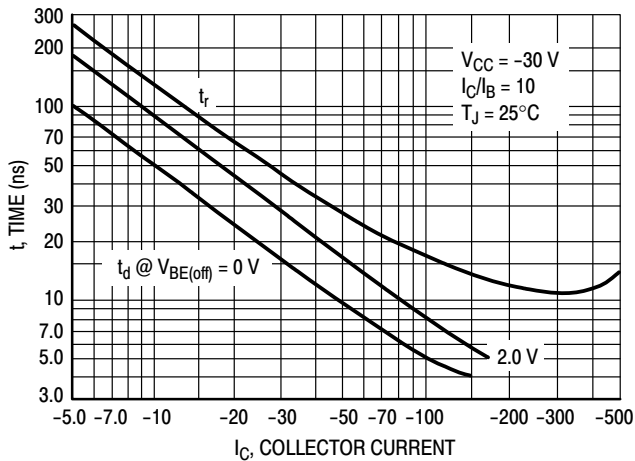

Figure 5. Turn-On Time

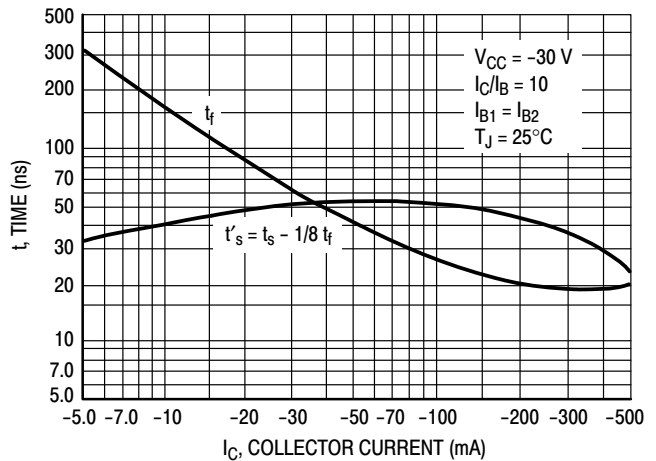

Figure 6. Turn-Off Time

MMBT2907AL, SMMBT2907AL

TYPICAL SMALL-SIGNAL Characteristics NOISE FIGURE

$V_{CE} = 10 \text{ Vdc}$, $T_A = 25^\circ\text{C}$

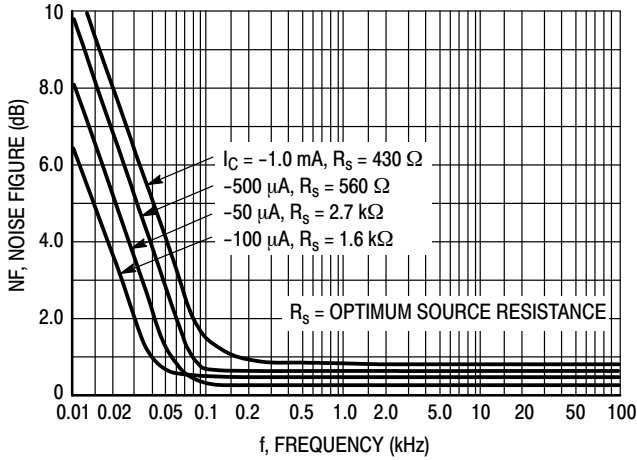

Figure 7. Frequency Effects

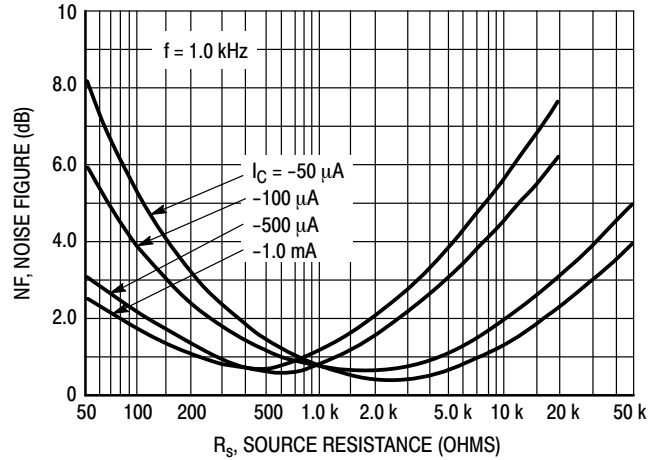

Figure 8. Source Resistance Effects

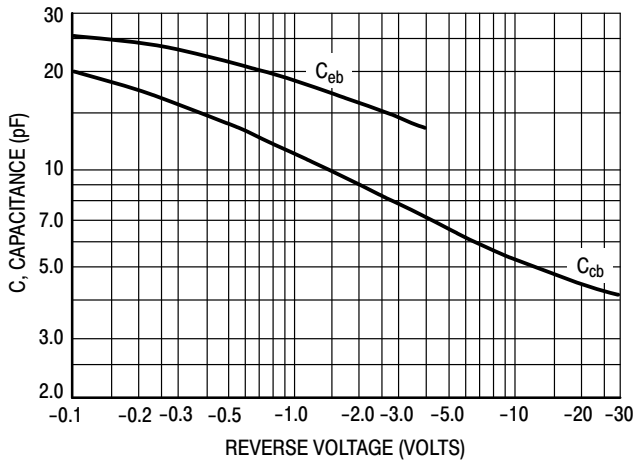

Figure 9. Capacitances

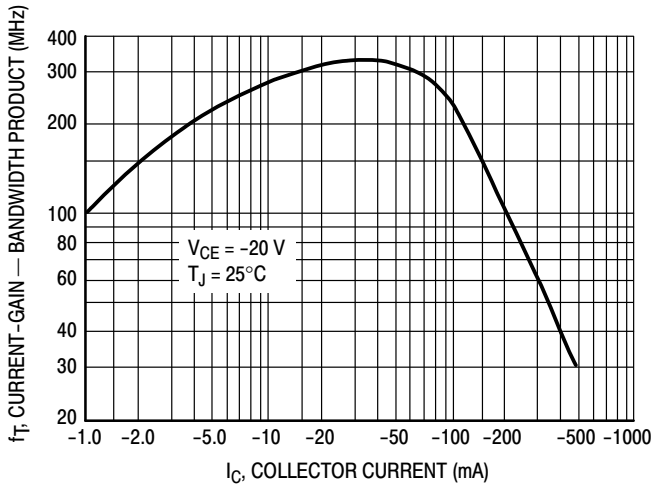

Figure 10. Current-Gain - Bandwidth Product

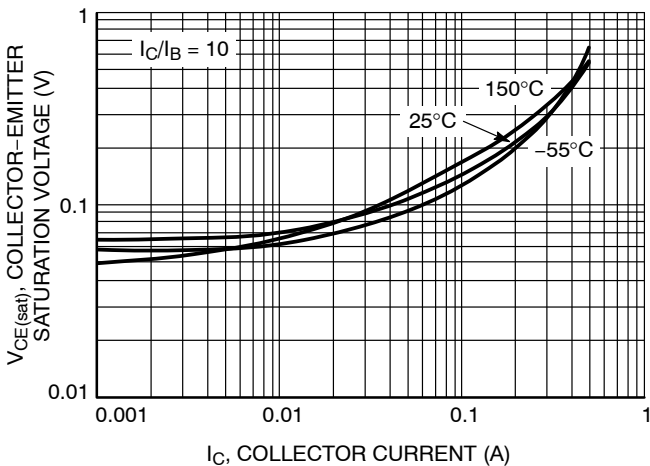

Figure 11. Collector-Emitter Saturation Voltage vs. Collector Current

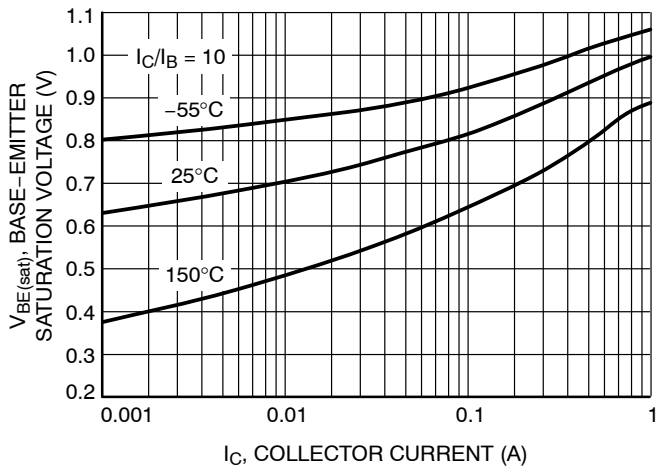

Figure 12. Base-Emitter Saturation Voltage vs. Collector Current

MMBT2907AL, SMMBT2907AL

TYPICAL SMALL-SIGNAL Characteristics NOISE FIGURE

$V_{CE} = 10 \text{ Vdc}$, $T_A = 25^\circ\text{C}$

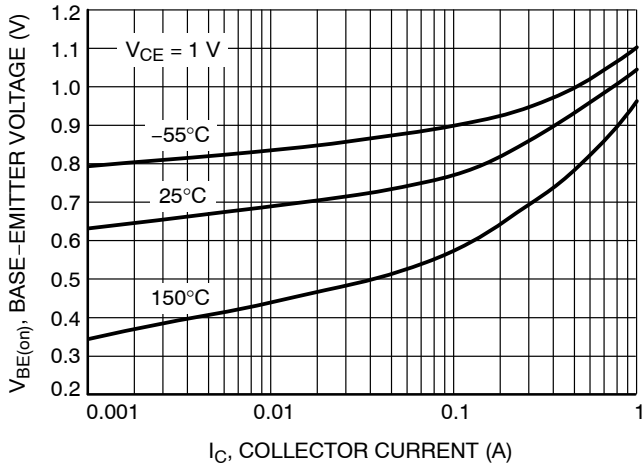

Figure 13. Base-Emitter Voltage vs. Collector Current

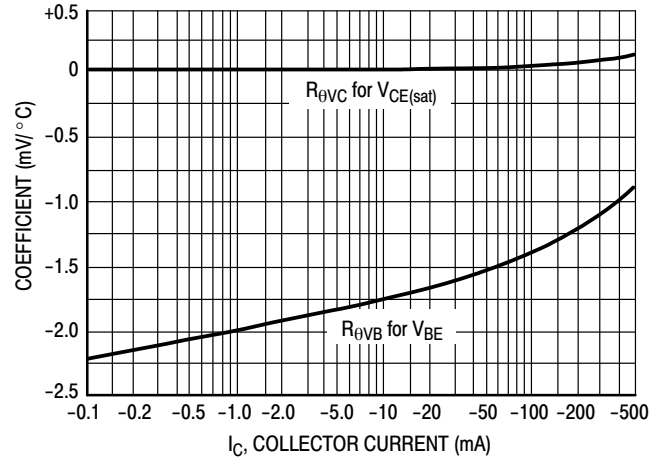

Figure 14. Temperature Coefficients

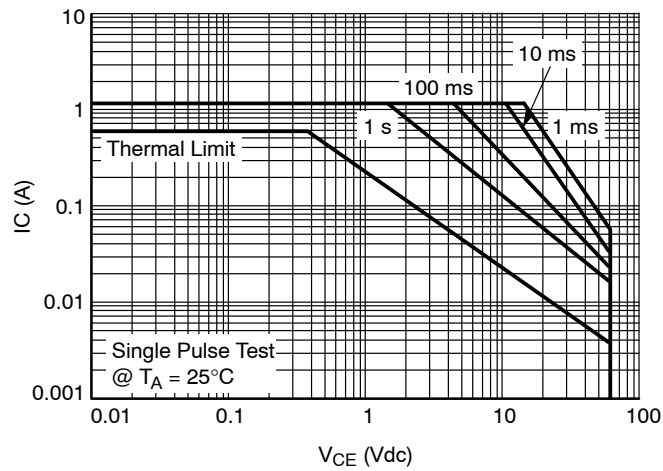
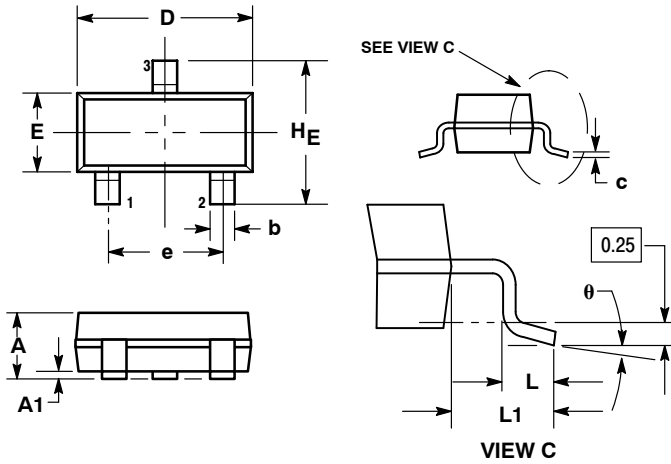

Figure 15. Safe Operating Area

MMBT2907AL, SMMBT2907AL

PACKAGE DIMENSIONS

SOT-23 (TO-236)
CASE 318-08
ISSUE AP



NOTES:

1. DIMENSIONING AND TOLERANCING PER ANSI Y14.5M, 1982.
2. CONTROLLING DIMENSION: INCH.
3. MAXIMUM LEAD THICKNESS INCLUDES LEAD FINISH THICKNESS. MINIMUM LEAD THICKNESS IS THE MINIMUM THICKNESS OF BASE MATERIAL.
4. DIMENSIONS D AND E DO NOT INCLUDE MOLD FLASH.

DIM	MILLIMETERS			INCHES		
	MIN	NOM	MAX	MIN	NOM	MAX
A	0.89	1.00	1.11	0.035	0.040	0.044
A1	0.01	0.06	0.10	0.001	0.002	0.004
b	0.37	0.44	0.50	0.015	0.018	0.020
c	0.09	0.13	0.18	0.003	0.005	0.007
D	2.80	2.90	3.04	0.110	0.114	0.120
E	1.20	1.30	1.40	0.047	0.051	0.055
e	1.78	1.90	2.04	0.070	0.075	0.081
L	0.10	0.20	0.30	0.004	0.008	0.012
L1	0.35	0.54	0.69	0.014	0.021	0.029
HE	2.10	2.40	2.64	0.083	0.094	0.104
θ	0°	---	10°	0°	---	10°

STYLE 6:
PIN 1. BASE
2. EMITTER
3. COLLECTOR

SOLDERING FOOTPRINT*

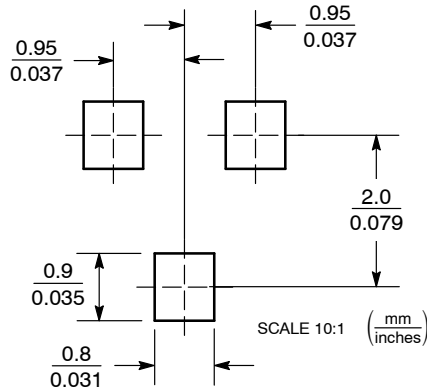

*For additional information on our Pb-Free strategy and soldering details, please download the ON Semiconductor Soldering and Mounting Techniques Reference Manual, SOLDERRM/D.

ON Semiconductor and are registered trademarks of Semiconductor Components Industries, LLC (SCILLC). SCILLC reserves the right to make changes without further notice to any products herein. SCILLC makes no warranty, representation or guarantee regarding the suitability of its products for any particular purpose, nor does SCILLC assume any liability arising out of the application or use of any product or circuit, and specifically disclaims any and all liability, including without limitation special, consequential or incidental damages. "Typical" parameters which may be provided in SCILLC data sheets and/or specifications can and do vary in different applications and actual performance may vary over time. All operating parameters, including "Typicals" must be validated for each customer application by customer's technical experts. SCILLC does not convey any license under its patent rights nor the rights of others. SCILLC products are not designed, intended, or authorized for use as components in systems intended for surgical implant into the body, or other applications intended to support or sustain life, or for any other application in which the failure of the SCILLC product could create a situation where personal injury or death may occur. Should Buyer purchase or use SCILLC products for any such unintended or unauthorized application, Buyer shall indemnify and hold SCILLC and its officers, employees, subsidiaries, affiliates, and distributors harmless against all claims, costs, damages, and expenses, and reasonable attorney fees arising out of, directly or indirectly, any claim of personal injury or death associated with such unintended or unauthorized use, even if such claim alleges that SCILLC was negligent regarding the design or manufacture of the part. SCILLC is an Equal Opportunity/Affirmative Action Employer. This literature is subject to all applicable copyright laws and is not for resale in any manner.