

**Cool MOS™ Power Transistor**
**Feature**

- New revolutionary high voltage technology
- Worldwide best  $R_{DS(on)}$  in TO 247
- Ultra low gate charge
- Periodic avalanche rated
- Extreme  $dv/dt$  rated
- Ultra low effective capacitances
- Pb-free lead plating; RoHS compliant
- Qualified according to JEDEC<sup>(0)</sup> for target applications

$V_{DS} @ T_{jmax}$	650	V
$R_{DS(on)}$	0.07	$\Omega$
$I_D$	47	A

PG-TO247

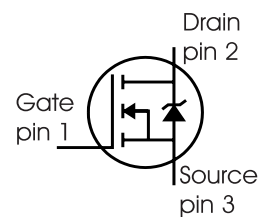

Type	Package	Ordering Code	Marking
SPW47N60C3	PG-TO247	Q67040-S4491	47N60C3

**Maximum Ratings**

Parameter	Symbol	Value	Unit
Continuous drain current $T_C = 25\text{ °C}$ $T_C = 100\text{ °C}$	$I_D$	47 30	A
Pulsed drain current, $t_p$ limited by $T_{jmax}$	$I_{D\text{ puls}}$	141	
Avalanche energy, single pulse $I_D = 10\text{ A}$ , $V_{DD} = 50\text{ V}$	$E_{AS}$	1800	mJ
Avalanche energy, repetitive $t_{AR}$ limited by $T_{jmax}$ <sup>1</sup> $I_D = 20\text{ A}$ , $V_{DD} = 50\text{ V}$	$E_{AR}$	1	
Avalanche current, repetitive $t_{AR}$ limited by $T_{jmax}$	$I_{AR}$	20	A
Gate source voltage static	$V_{GS}$	$\pm 20$	V
Gate source voltage AC ( $f > 1\text{ Hz}$ )	$V_{GS}$	$\pm 30$	
Power dissipation, $T_C = 25\text{ °C}$	$P_{tot}$	415	W
Operating and storage temperature	$T_j, T_{stg}$	-55... +150	$^{\circ}\text{C}$
Reverse diode $dv/dt$ <sup>4)</sup>	$dv/dt$	15	V/ns

**Maximum Ratings**

Parameter	Symbol	Value	Unit
Drain Source voltage slope $V_{DS} = 480\text{ V}$ , $I_D = 47\text{ A}$ , $T_j = 125\text{ °C}$	$dv/dt$	50	V/ns

**Thermal Characteristics**

Parameter	Symbol	Values			Unit
		min.	typ.	max.	
Thermal resistance, junction - case	$R_{thJC}$	-	-	0.3	K/W
Thermal resistance, junction - ambient, leaded	$R_{thJA}$	-	-	62	
Soldering temperature, wavesoldering 1.6 mm (0.063 in.) from case for 10s	$T_{sold}$	-	-	260	°C

**Electrical Characteristics, at  $T_j=25\text{ °C}$  unless otherwise specified**

Parameter	Symbol	Conditions	Values			Unit
			min.	typ.	max.	
Drain-source breakdown voltage	$V_{(BR)DSS}$	$V_{GS}=0V$ , $I_D=0.25mA$	600	-	-	V
Drain-Source avalanche breakdown voltage	$V_{(BR)DS}$	$V_{GS}=0V$ , $I_D=20A$	-	700	-	
Gate threshold voltage	$V_{GS(th)}$	$I_D=2700\mu A$ , $V_{GS}=V_{DS}$	2.1	3	3.9	
Zero gate voltage drain current	$I_{DSS}$	$V_{DS}=600V$ , $V_{GS}=0V$ , $T_j=25\text{ °C}$ , $T_j=150\text{ °C}$	-	0.5	25	$\mu A$
Gate-source leakage current	$I_{GSS}$	$V_{GS}=30V$ , $V_{DS}=0V$	-	-	100	
Drain-source on-state resistance	$R_{DS(on)}$	$V_{GS}=10V$ , $I_D=30A$ , $T_j=25\text{ °C}$ $T_j=150\text{ °C}$	-	0.06	0.07	$\Omega$
Gate input resistance	$R_G$	$f=1MHz$ , open Drain	-	0.62	-	

**Electrical Characteristics** , at  $T_j = 25\text{ }^\circ\text{C}$ , unless otherwise specified

Parameter	Symbol	Conditions	Values			Unit
			min.	typ.	max.	
Transconductance	$g_{fs}$	$V_{DS} \geq 2 \cdot I_D \cdot R_{DS(on)max}$ , $I_D = 30\text{A}$	-	40	-	S
Input capacitance	$C_{iss}$	$V_{GS} = 0\text{V}$ , $V_{DS} = 25\text{V}$ , $f = 1\text{MHz}$	-	6800	-	pF
Output capacitance	$C_{oss}$		-	2200	-	
Reverse transfer capacitance	$C_{rss}$		-	145	-	
Effective output capacitance, <sup>2)</sup> energy related	$C_{o(er)}$	$V_{GS} = 0\text{V}$ , $V_{DS} = 0\text{V to } 480\text{V}$	-	193	-	pF
Effective output capacitance, <sup>3)</sup> time related	$C_{o(tr)}$		-	412	-	
Turn-on delay time	$t_{d(on)}$	$V_{DD} = 380\text{V}$ , $V_{GS} = 0/13\text{V}$ , $I_D = 47\text{A}$ , $R_G = 1.8\Omega$ , $T_j = 125$	-	18	-	ns
Rise time	$t_r$		-	27	-	
Turn-off delay time	$t_{d(off)}$		-	111	165	
Fall time	$t_f$		-	8	12	

**Gate Charge Characteristics**

Gate to source charge	$Q_{gs}$	$V_{DD} = 350\text{V}$ , $I_D = 47\text{A}$	-	24	-	nC
Gate to drain charge	$Q_{gd}$		-	121	-	
Gate charge total	$Q_g$	$V_{DD} = 350\text{V}$ , $I_D = 47\text{A}$ , $V_{GS} = 0\text{ to } 10\text{V}$	-	252	320	
Gate plateau voltage	$V_{(plateau)}$	$V_{DD} = 350\text{V}$ , $I_D = 47\text{A}$	-	5.5	-	V

<sup>0</sup>J-STD20 and JESD22

<sup>1</sup>Repetitive avalanche causes additional power losses that can be calculated as  $P_{AV} = E_{AR} \cdot f$ .

<sup>2</sup> $C_{o(er)}$  is a fixed capacitance that gives the same stored energy as  $C_{oss}$  while  $V_{DS}$  is rising from 0 to 80%  $V_{DSS}$ .

<sup>3</sup> $C_{o(tr)}$  is a fixed capacitance that gives the same charging time as  $C_{oss}$  while  $V_{DS}$  is rising from 0 to 80%  $V_{DSS}$ .

<sup>4</sup> $I_{SD} \leq I_D$ ,  $di/dt \leq 200\text{A}/\mu\text{s}$ ,  $V_{DClink} = 400\text{V}$ ,  $V_{peak} < V_{BR, DSS}$ ,  $T_j < T_{j,max}$ .

Identical low-side and high-side switch.

**Electrical Characteristics**, at  $T_j = 25\text{ }^\circ\text{C}$ , unless otherwise specified

Parameter	Symbol	Conditions	Values			Unit
			min.	typ.	max.	
Inverse diode continuous forward current	$I_S$	$T_C=25^\circ\text{C}$	-	-	47	A
Inverse diode direct current, pulsed	$I_{SM}$		-	-	141	
Inverse diode forward voltage	$V_{SD}$	$V_{GS}=0\text{V}, I_F=I_S$	-	1	1.2	V
Reverse recovery time	$t_{rr}$	$V_R=350\text{V}, I_F=I_S,$ $di_F/dt=100\text{A}/\mu\text{s}$	-	580	-	ns
Reverse recovery charge	$Q_{rr}$		-	23	-	$\mu\text{C}$
Peak reverse recovery current	$I_{rrm}$		-	73	-	A
Peak rate of fall of reverse recovery current	$di_{rr}/dt$		-	900	-	$\text{A}/\mu\text{s}$

**Typical Transient Thermal Characteristics**

Symbol	Value	Unit	Symbol	Value	Unit
	typ.			typ.	
Thermal resistance			Thermal capacitance		
$R_{th1}$	0.002689	K/W	$C_{th1}$	0.001081	Ws/K
$R_{th2}$	0.005407		$C_{th2}$	0.004021	
$R_{th3}$	0.011		$C_{th3}$	0.005415	
$R_{th4}$	0.054		$C_{th4}$	0.014	
$R_{th5}$	0.071		$C_{th5}$	0.025	
$R_{th6}$	0.036		$C_{th6}$	0.158	

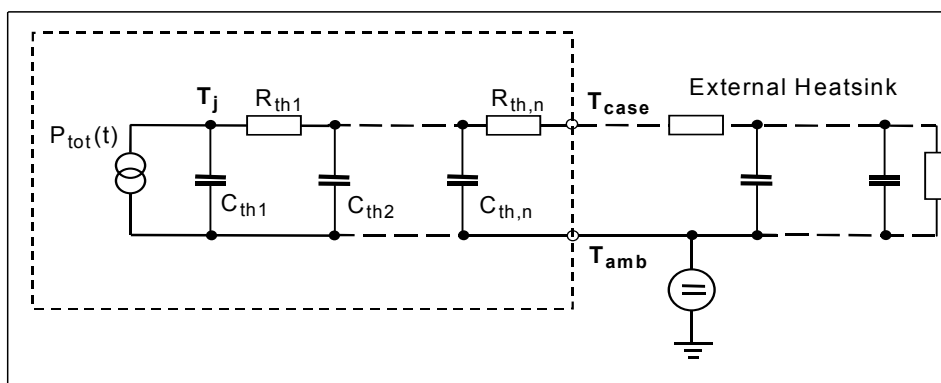

**1 Power dissipation**

$$P_{tot} = f(T_C)$$

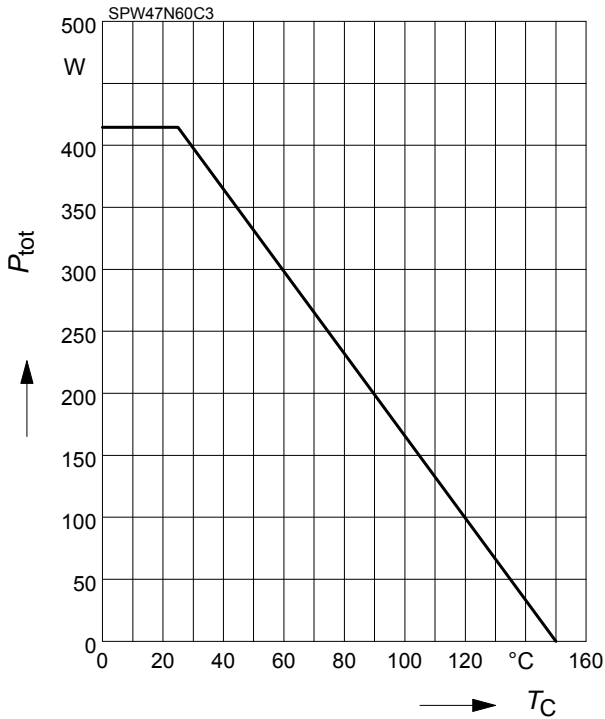

**2 Safe operating area**

$$I_D = f(V_{DS})$$

parameter :  $D = 0$  ,  $T_C = 25^\circ\text{C}$

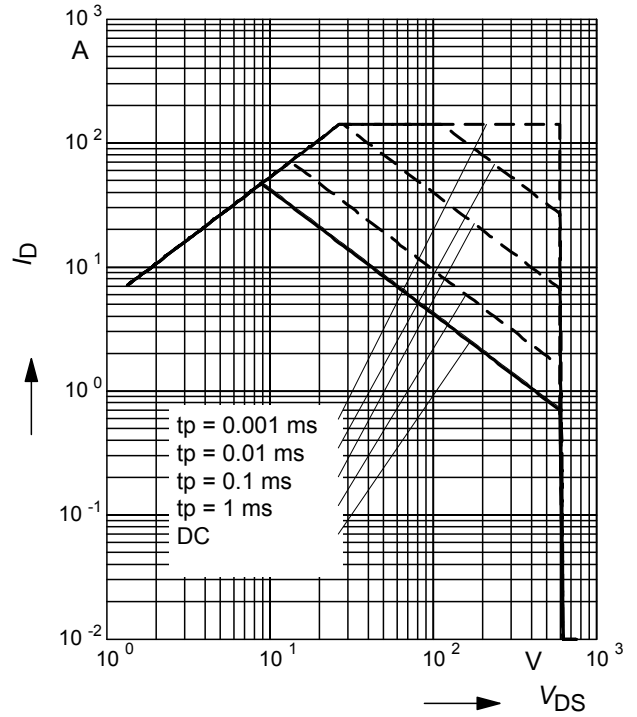

**3 Transient thermal impedance**

$$Z_{thJC} = f(t_p)$$

parameter:  $D = t_p/T$

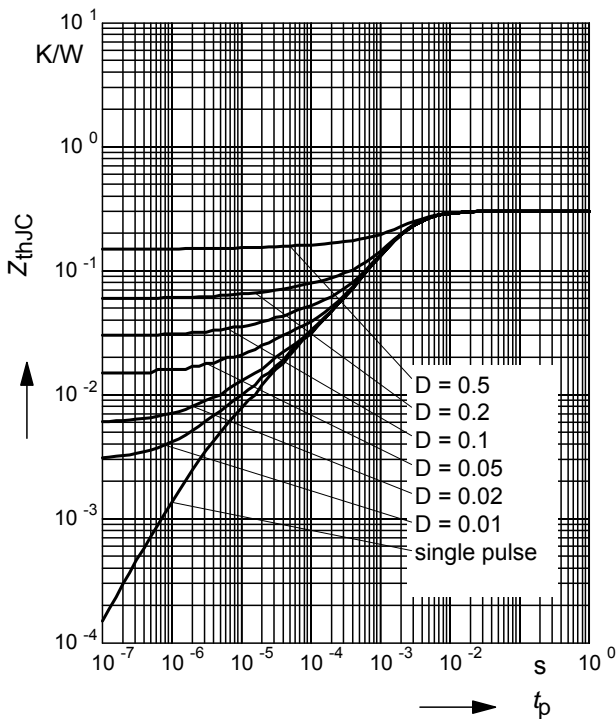

**4 Typ. output characteristic**

$$I_D = f(V_{DS}); T_j = 25^\circ\text{C}$$

parameter:  $t_p = 10 \mu\text{s}$  ,  $V_{GS}$

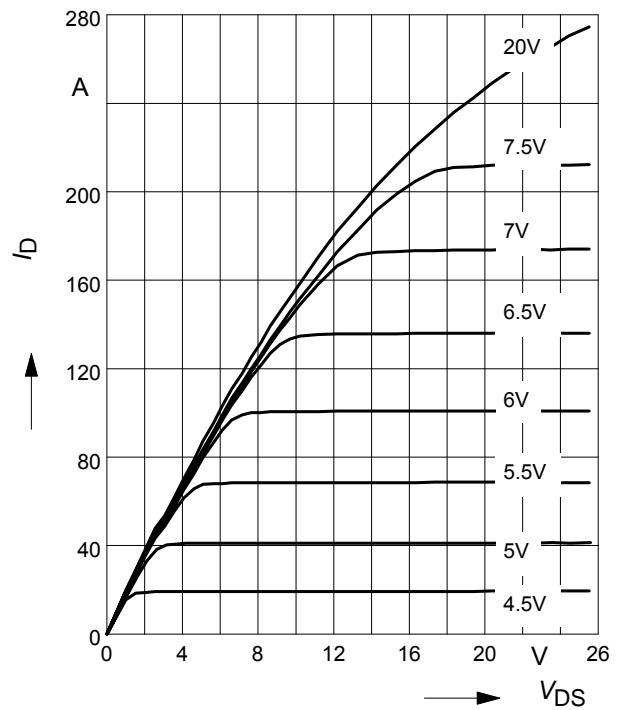

**5 Typ. output characteristic**

$I_D = f(V_{DS}); T_j = 150^\circ\text{C}$

parameter:  $t_p = 10 \mu\text{s}, V_{GS}$

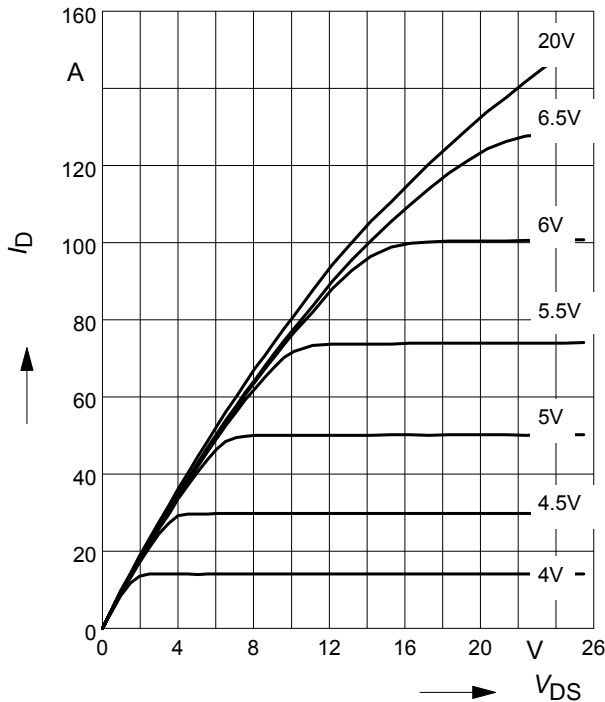

**6 Typ. drain-source on resistance**

$R_{DS(on)} = f(I_D)$

parameter:  $T_j = 150^\circ\text{C}, V_{GS}$

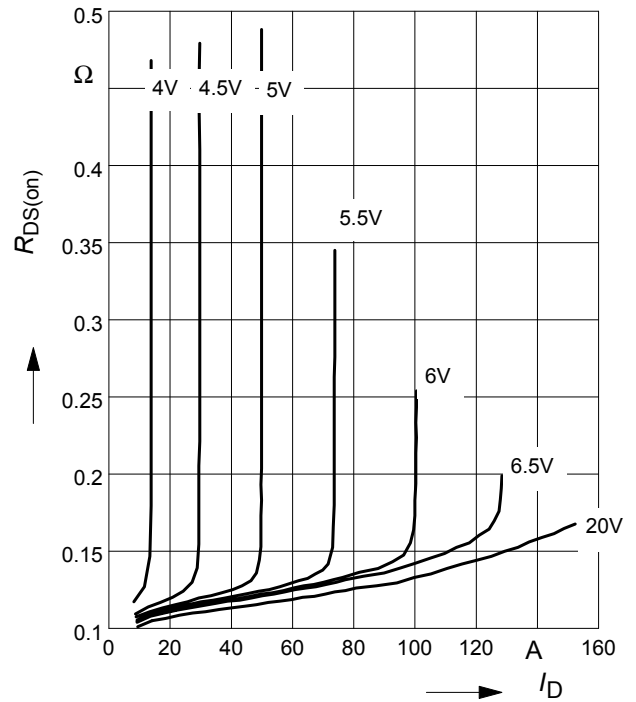

**7 Drain-source on-state resistance**

$R_{DS(on)} = f(T_j)$

parameter:  $I_D = 47 \text{ A}, V_{GS} = 10 \text{ V}$

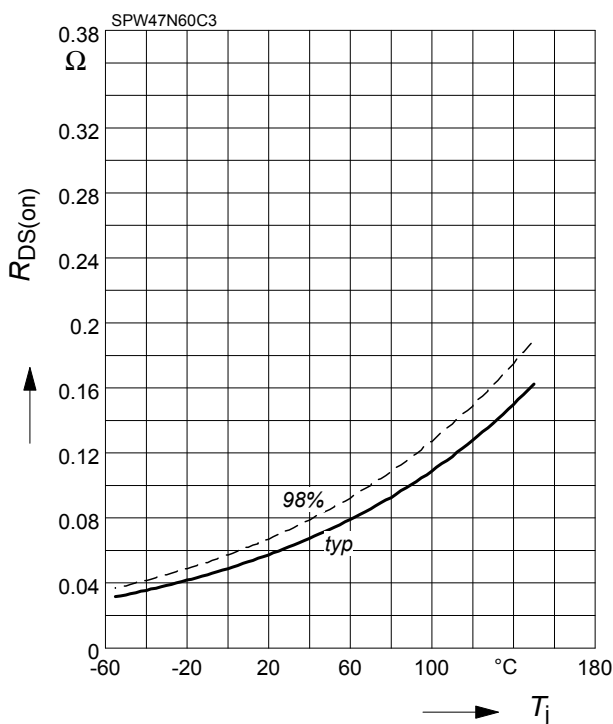

**8 Typ. transfer characteristics**

$I_D = f(V_{GS}); V_{DS} \geq 2 \times I_D \times R_{DS(on)max}$

parameter:  $t_p = 10 \mu\text{s}$

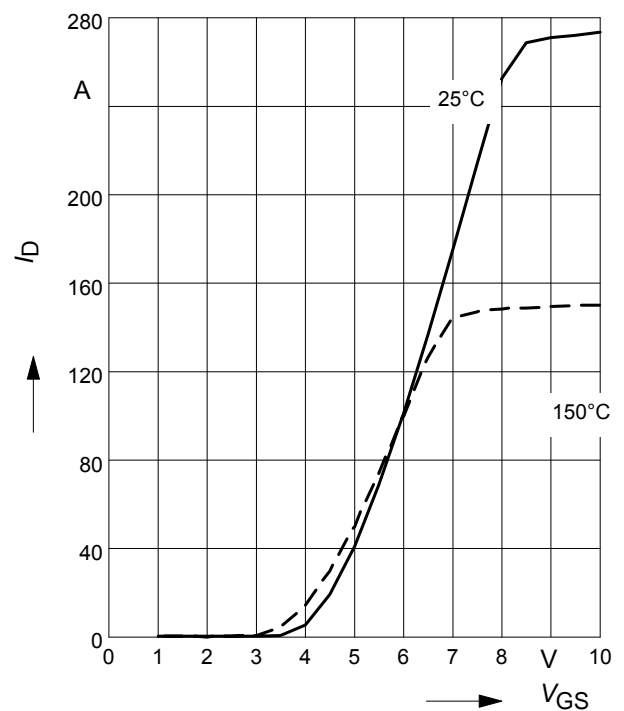

**9 Typ. gate charge**

$V_{GS} = f(Q_{Gate})$

parameter:  $I_D = 47\text{ A}$  pulsed

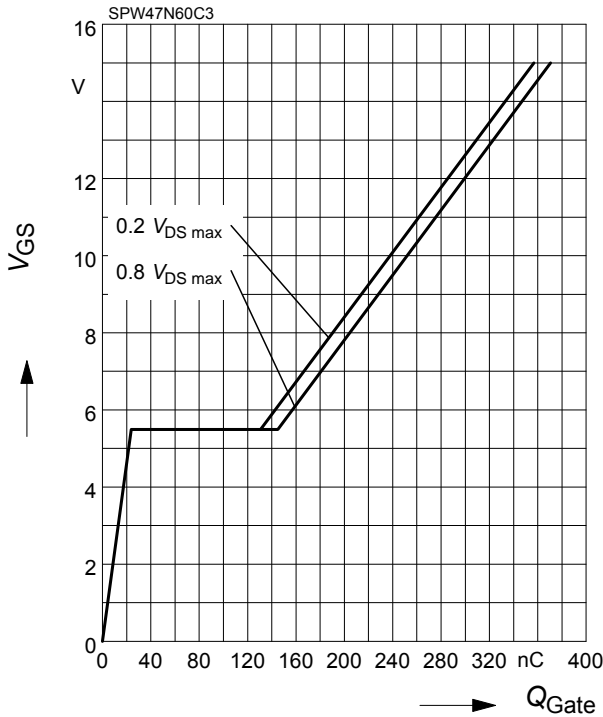

**10 Forward characteristics of body diode**

$I_F = f(V_{SD})$

parameter:  $T_j, t_p = 10\ \mu\text{s}$

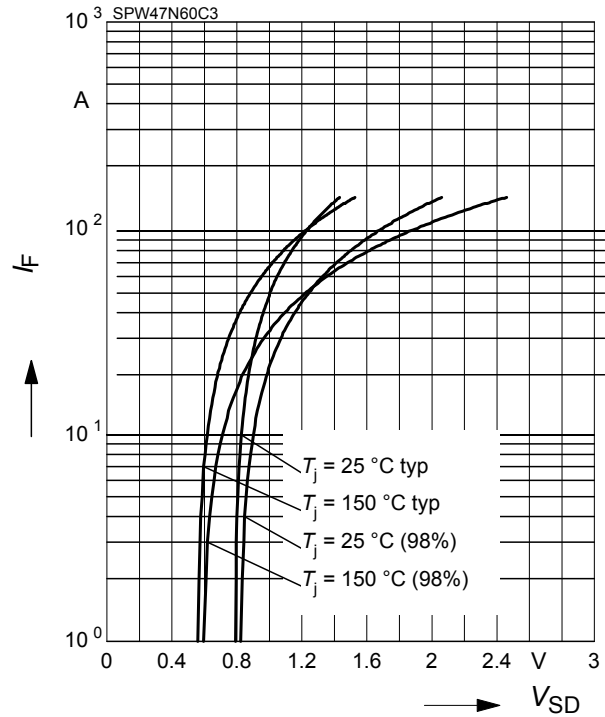

**11 Typ. drain current slope**

$di/dt = f(R_G)$ , inductive load,  $T_j = 125^\circ\text{C}$

par.:  $V_{DS}=380\text{V}$ ,  $V_{GS}=0/+13\text{V}$ ,  $I_D=47\text{A}$

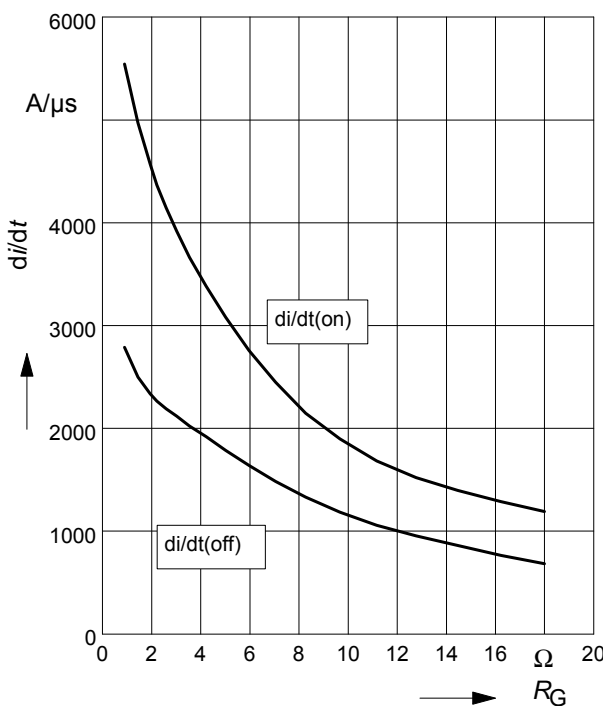

**12 Typ. switching time**

$t = f(R_G)$ , inductive load,  $T_j=125^\circ\text{C}$

par.:  $V_{DS}=380\text{V}$ ,  $V_{GS}=0/+13\text{V}$ ,  $I_D=47\text{ A}$

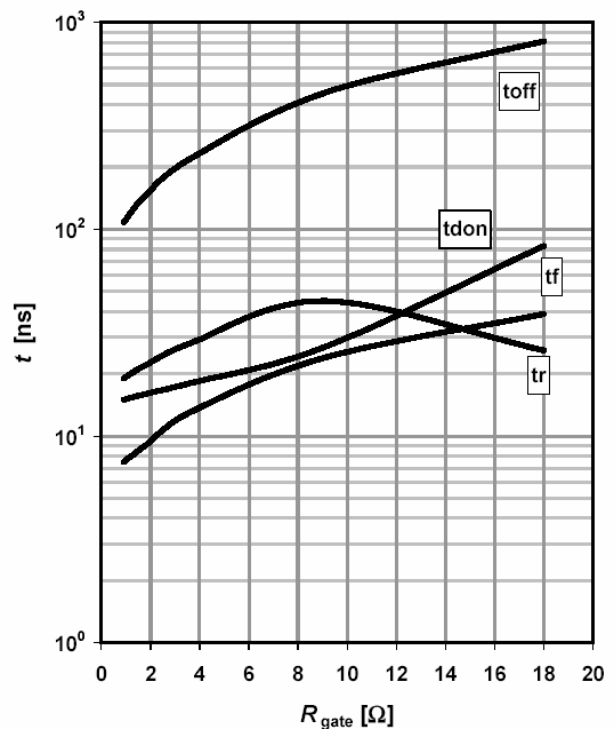

**13 Typ. switching time**

$t = f(I_D)$ , inductive load,  $T_j=125^\circ\text{C}$   
 par.:  $V_{DS}=380\text{V}$ ,  $V_{GS}=0/+13\text{V}$ ,  $R_G=1.8\Omega$

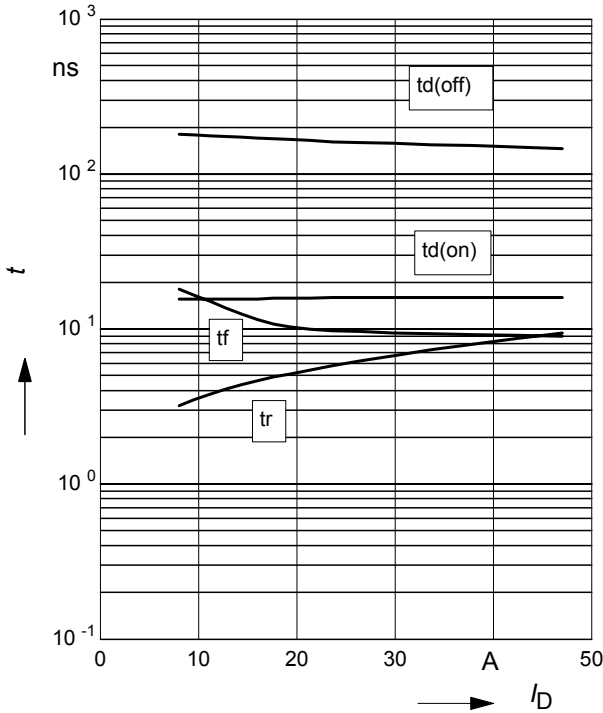

**14 Typ. drain source voltage slope**

$dv/dt = f(R_G)$ , inductive load,  $T_j = 125^\circ\text{C}$   
 par.:  $V_{DS}=380\text{V}$ ,  $V_{GS}=0/+13\text{V}$ ,  $I_D=47\text{A}$

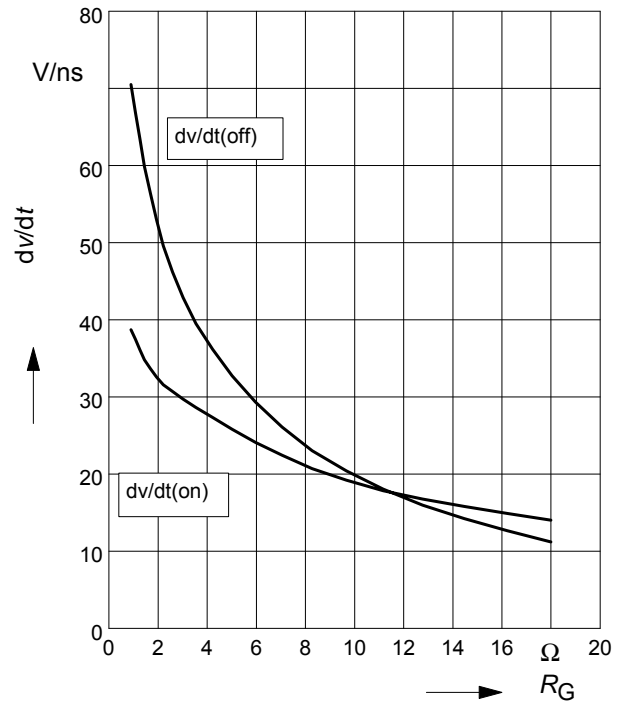

**15 Typ. switching losses**

$E = f(I_D)$ , inductive load,  $T_j=125^\circ\text{C}$   
 par.:  $V_{DS}=380\text{V}$ ,  $V_{GS}=0/+13\text{V}$ ,  $R_G=1.8\Omega$

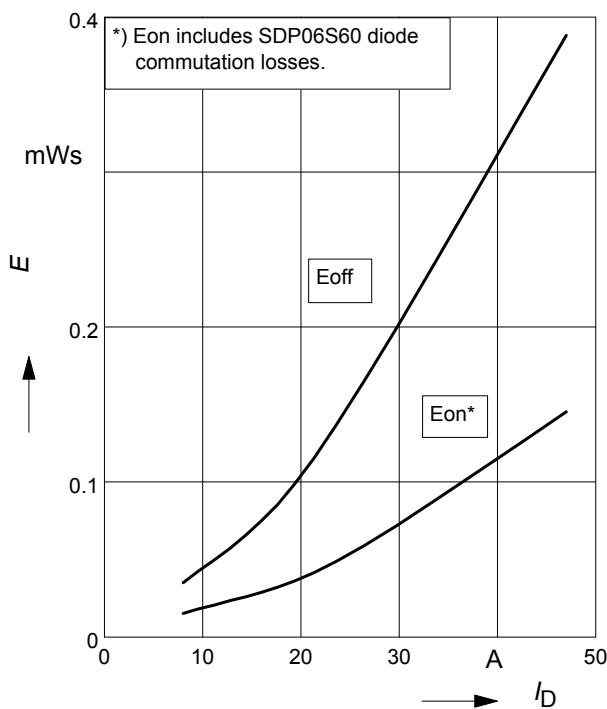

**16 Typ. switching losses**

$E = f(R_G)$ , inductive load,  $T_j=125^\circ\text{C}$   
 par.:  $V_{DS}=380\text{V}$ ,  $V_{GS}=0/+13\text{V}$ ,  $I_D=47\text{A}$

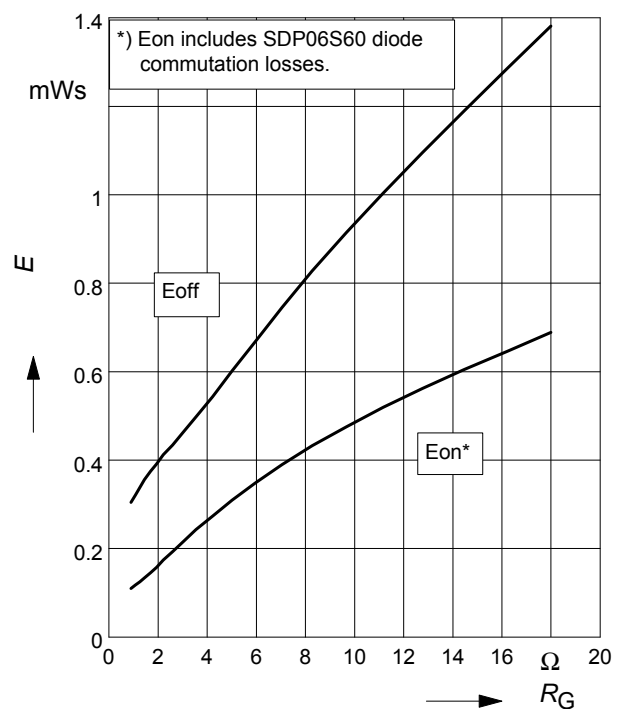



**17 Avalanche SOA**

$$I_{AR} = f(t_{AR})$$

par.:  $T_j \leq 150\text{ }^\circ\text{C}$

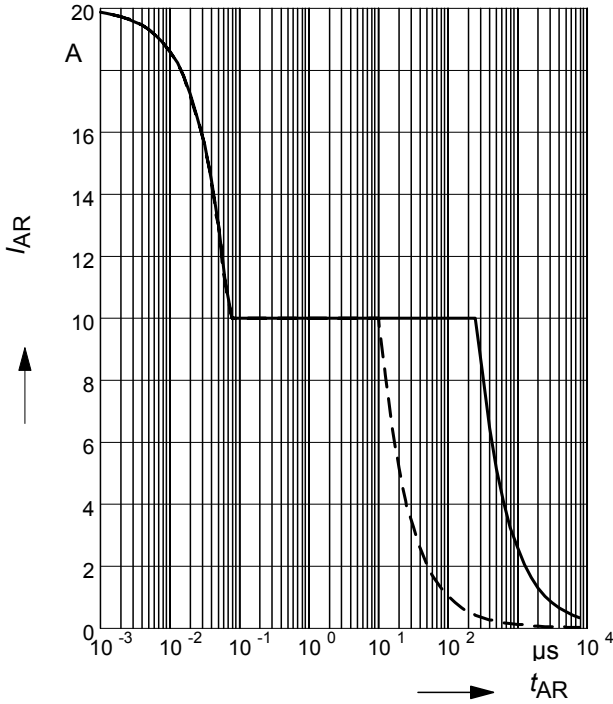

**18 Avalanche energy**

$$E_{AS} = f(T_j)$$

par.:  $I_D = 10\text{ A}$ ,  $V_{DD} = 50\text{ V}$

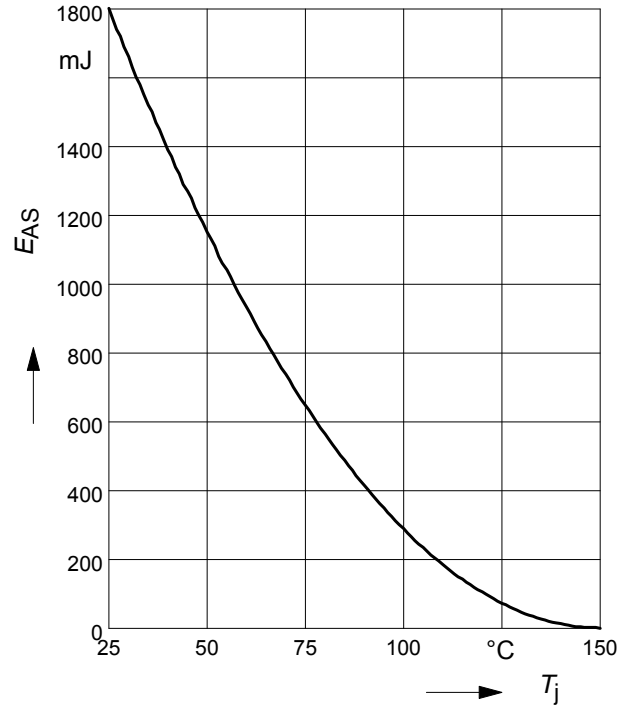

**19 Drain-source breakdown voltage**

$$V_{(BR)DSS} = f(T_j)$$

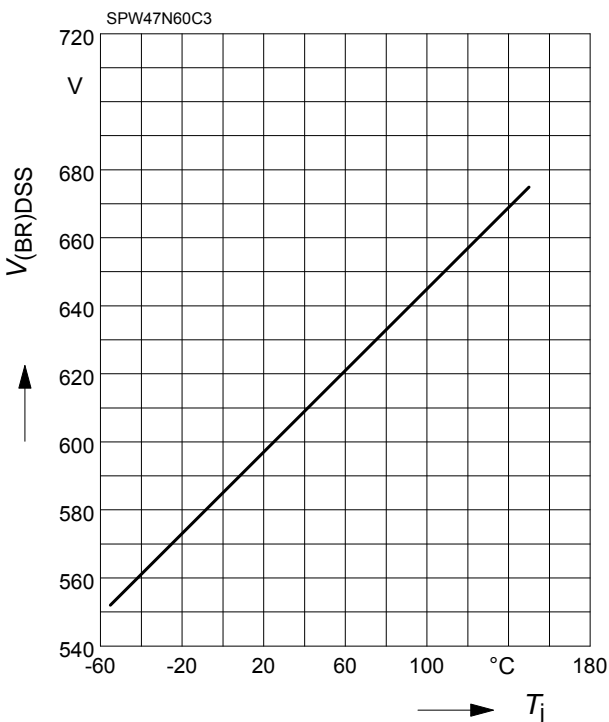

**20 Avalanche power losses**

$$P_{AR} = f(f)$$

parameter:  $E_{AR} = 1\text{ mJ}$

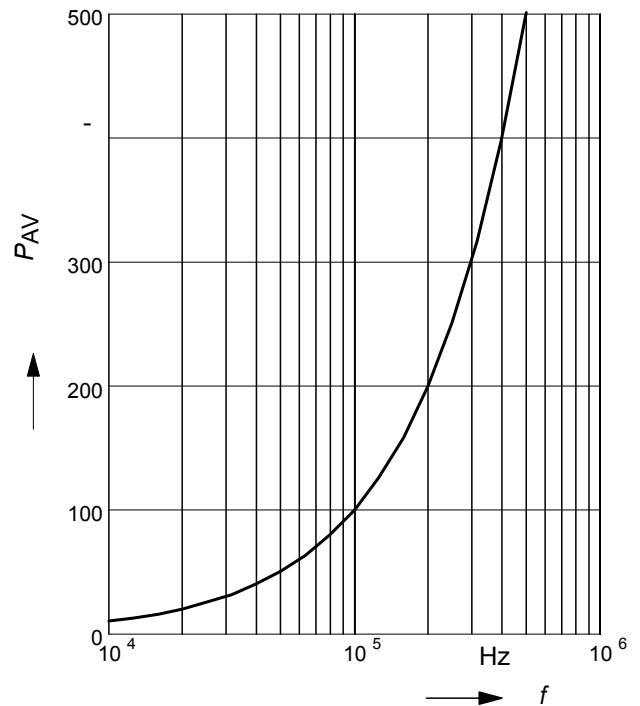

**21 Typ. capacitances**

$$C = f(V_{DS})$$

parameter:  $V_{GS}=0V, f=1\text{ MHz}$

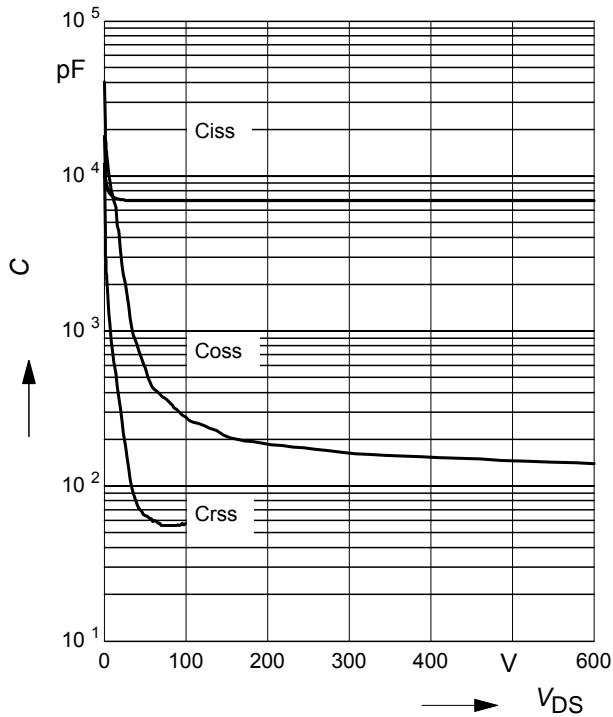

**22 Typ.  $C_{OSS}$  stored energy**

$$E_{OSS} = f(V_{DS})$$

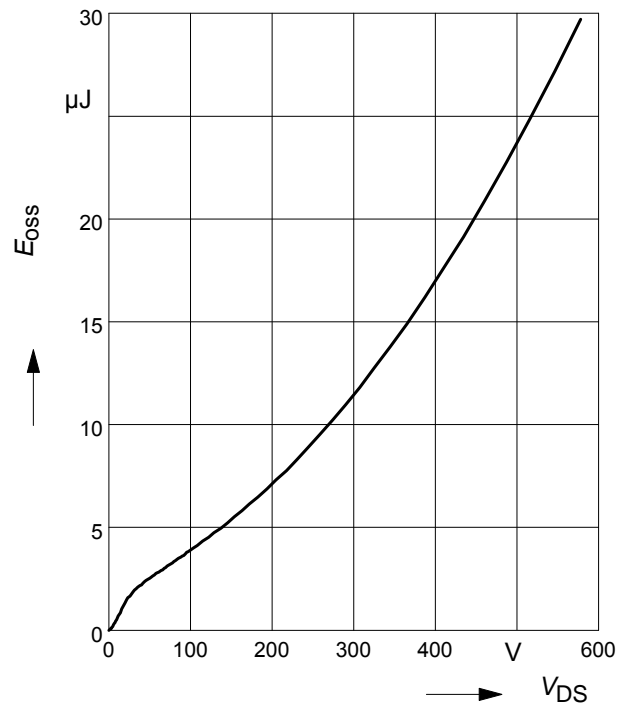

**23 Typ. gate threshold voltage**

$$V_{GS(th)} = f(T_j)$$

parameter:  $V_{GS} = V_{DS} ; I_D = 2.7\text{ mA}$

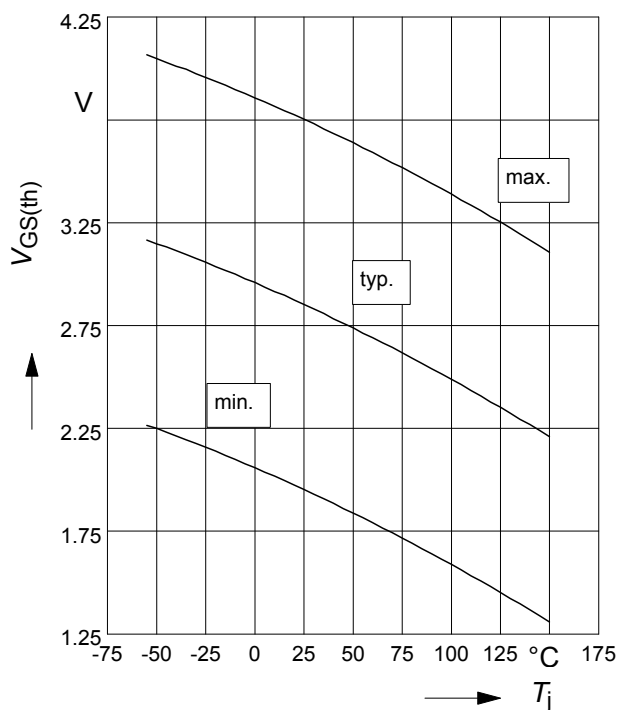

Definition of diodes switching characteristics

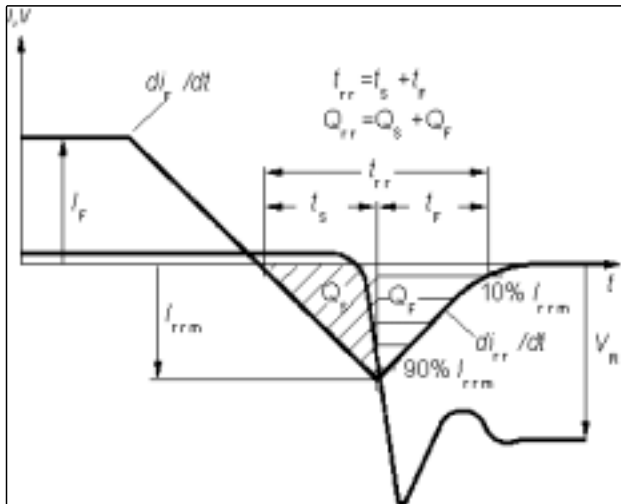

PG-TO-247-3-1

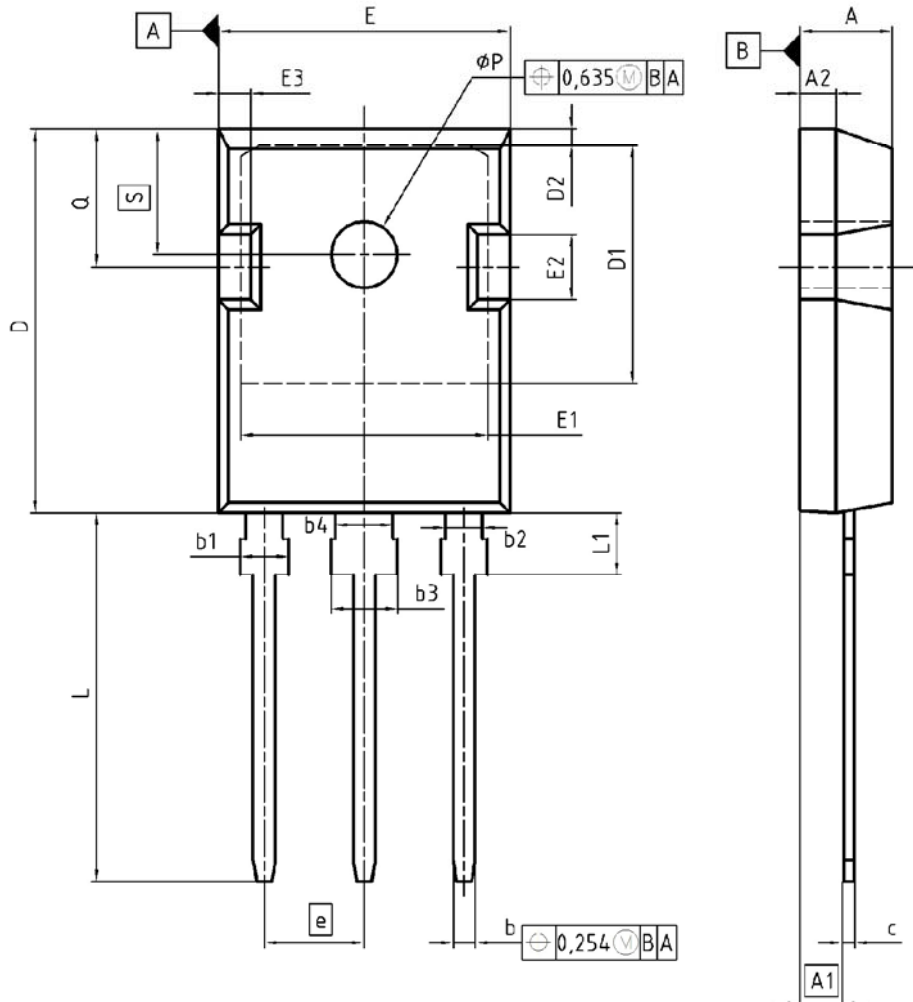

DIM	MILLIMETERS		INCHES	
	MIN	MAX	MIN	MAX
A	4.90	5.16	0.193	0.203
A1	2.27	2.53	0.089	0.099
A2	1.85	2.11	0.073	0.083
b	1.07	1.33	0.042	0.052
b1	1.90	2.41	0.075	0.095
b2	1.90	2.16	0.075	0.085
b3	2.87	3.38	0.113	0.133
b4	2.87	3.13	0.113	0.123
c	0.55	0.68	0.022	0.027
D	20.82	21.10	0.820	0.831
D1	16.25	17.65	0.640	0.695
D2	1.05	1.35	0.041	0.053
E	15.70	16.03	0.618	0.631
E1	13.10	14.15	0.516	0.557
E2	3.68	5.10	0.145	0.201
E3	1.68	2.60	0.066	0.102
e	5.44		0.214	
N	3		3	
L	19.80	20.31	0.780	0.799
L1	4.17	4.47	0.164	0.176
$\phi P$	3.50	3.70	0.138	0.146
Q	5.49	6.00	0.216	0.236
S	6.04	6.30	0.238	0.248

DOCUMENT NO.  
Z8B0003327

SCALE

EUROPEAN PROJECTION

ISSUE DATE  
17-12-2007

REVISION  
03

**Published by**  
**Infineon Technologies AG**  
**81726 Munich, Germany**  
**© 2008 Infineon Technologies AG**  
**All Rights Reserved.**

#### **Legal Disclaimer**

The information given in this document shall in no event be regarded as a guarantee of conditions or characteristics. With respect to any examples or hints given herein, any typical values stated herein and/or any information regarding the application of the device, Infineon Technologies hereby disclaims any and all warranties and liabilities of any kind, including without limitation, warranties of non-infringement of intellectual property rights of any third party.

#### **Information**

For further information on technology, delivery terms and conditions and prices, please contact the nearest Infineon Technologies Office ([www.infineon.com](http://www.infineon.com)).

#### **Warnings**

Due to technical requirements, components may contain dangerous substances. For information on the types in question, please contact the nearest Infineon Technologies Office. Infineon Technologies components may be used in life-support devices or systems only with the express written approval of Infineon Technologies, if a failure of such components can reasonably be expected to cause the failure of that life-support device or system or to affect the safety or effectiveness of that device or system. Life support devices or systems are intended to be implanted in the human body or to support and/or maintain and sustain and/or protect human life. If they fail, it is reasonable to assume that the health of the user or other persons may be endangered.

# 1 New package outlines TO-247

Assembly capacity extension for CoolMOSTM technology products assembled in lead-free package PG-TO247-3 at subcontractor ASE (Weihai) Inc., China (Changes are marked in blue.)

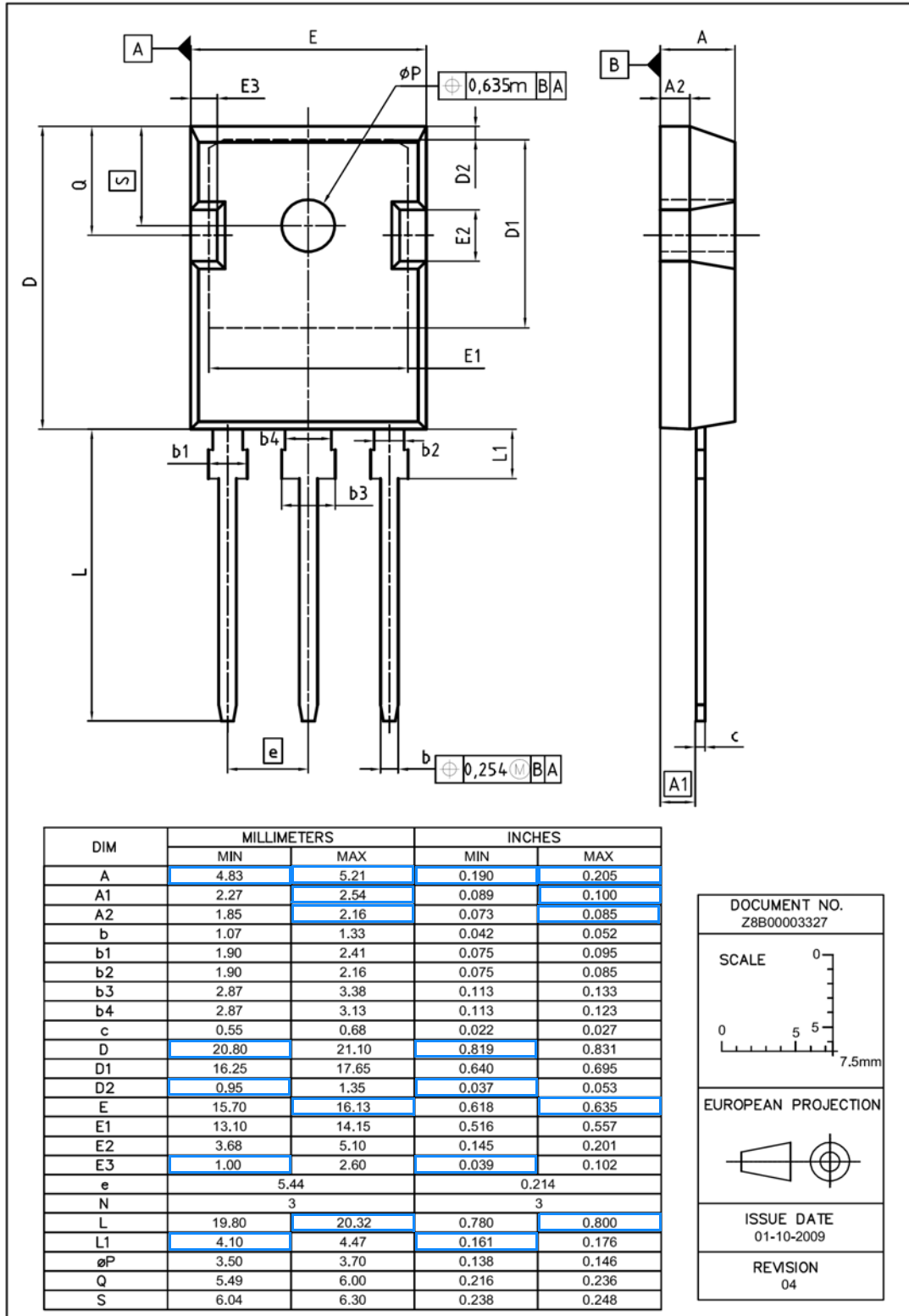

Figure 1 Outlines TO-247, dimensions in mm/inches