

N-Channel Power MOSFET

600V, 0.6A, 5Ω

FEATURES

- Robust high voltage termination
- Avalanche energy specified
- Diode is characterized for use in bridge circuits
- Source to Drain diode recovery time comparable to a discrete fast recovery diode.

| KEY PERFORMANCE PARAMETERS | | |
|----------------------------|-------|------|
| PARAMETER | VALUE | UNIT |
| V_{DS} | 600 | V |
| $R_{DS(on)}$ (max) | 5 | Ω |
| Q_g | 13 | nC |

APPLICATION

- Power Supply
- Lighting
- Charger



SOT-223

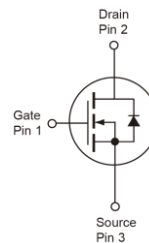

Notes: MSL 3 (Moisture Sensitivity Level) per J-STD-020

| ABSOLUTE MAXIMUM RATINGS ($T_A = 25^\circ\text{C}$ unless otherwise noted) | | | |
|---|----------------|---------------------------|------|
| PARAMETER | SYMBOL | LIMIT | UNIT |
| Drain-Source Voltage | V_{DS} | 600 | V |
| Gate-Source Voltage | V_{GS} | ±30 | V |
| Continuous Drain Current ^(Note 1) | I_D | $T_C = 25^\circ\text{C}$ | 0.6 |
| | | $T_C = 100^\circ\text{C}$ | 0.36 |
| Pulsed Drain Current ^(Note 2) | I_{DM} | 1.5 | A |
| Total Power Dissipation @ $T_C = 25^\circ\text{C}$ | P_{DTOT} | 2.5 | W |
| Single Pulsed Avalanche Energy ^(Note 3) | E_{AS} | 62 | mJ |
| Single Pulsed Avalanche Current ^(Note 3) | I_{AS} | 2.5 | A |
| Operating Junction Temperature | T_J | 150 | °C |
| Operating Junction and Storage Temperature Range | T_J, T_{STG} | - 55 to +150 | °C |

| THERMAL PERFORMANCE | | | |
|--|-----------------|-------|------|
| PARAMETER | SYMBOL | LIMIT | UNIT |
| Junction to Case Thermal Resistance | $R_{\theta JC}$ | 15 | °C/W |
| Junction to Ambient Thermal Resistance | $R_{\theta JA}$ | 55.8 | °C/W |

Notes: $R_{\theta JA}$ is the sum of the junction-to-case and case-to-ambient thermal resistances. The case thermal reference is defined at the solder mounting surface of the drain pins. $R_{\theta JA}$ is guaranteed by design while $R_{\theta CA}$ is determined by the user's board design. $R_{\theta JA}$ shown below for single device operation on FR-4 PCB with minimum recommended footprint in still air

| ELECTRICAL SPECIFICATIONS ($T_A = 25^\circ\text{C}$ unless otherwise noted) | | | | | | |
|---|---|--------------|-----|------|-----------|----------|
| PARAMETER | CONDITIONS | SYMBOL | MIN | TYP | MAX | UNIT |
| Static (Note 4) | | | | | | |
| Drain-Source Breakdown Voltage | $V_{GS} = 0V, I_D = 250\mu A$ | BV_{DSS} | 600 | -- | -- | V |
| Gate Threshold Voltage | $V_{DS} = V_{GS}, I_D = 250\mu A$ | $V_{GS(TH)}$ | 2 | -- | 4 | V |
| Gate Body Leakage | $V_{GS} = \pm 30V, V_{DS} = 0V$ | I_{GSS} | -- | -- | ± 100 | nA |
| Zero Gate Voltage Drain Current | $V_{DS} = 600V, V_{GS} = 0V$ | I_{DSS} | -- | -- | 1 | μA |
| Drain-Source On-State Resistance | $V_{GS} = 10V, I_D = 0.6A$ | $R_{DS(ON)}$ | -- | 3.6 | 5 | Ω |
| Forward Transconductance | $V_{DS} = 10V, I_D = 0.2A$ | g_{fs} | -- | 0.8 | -- | S |
| Dynamic (Note 5) | | | | | | |
| Total Gate Charge | $V_{DS} = 400V, I_D = 0.6A,$ $V_{GS} = 10V$ | Q_g | -- | 13 | -- | nC |
| Gate-Source Charge | | Q_{gs} | -- | 2 | -- | |
| Gate-Drain Charge | | Q_{gd} | -- | 6 | -- | |
| Input Capacitance | $V_{DS} = 25V, V_{GS} = 0V,$ $f = 1.0\text{MHz}$ | C_{iss} | -- | 435 | -- | pF |
| Output Capacitance | | C_{oss} | -- | 56 | -- | |
| Reverse Transfer Capacitance | | C_{rss} | -- | 9.2 | -- | |
| Switching (Note 6) | | | | | | |
| Turn-On Delay Time | $V_{GS} = 10V, I_D = 0.6A,$ $V_{DD} = 300V, R_G = 18\Omega,$ | $t_{d(on)}$ | -- | 12 | -- | ns |
| Turn-On Rise Time | | t_r | -- | 21 | -- | |
| Turn-Off Delay Time | | $t_{d(off)}$ | -- | 30 | -- | |
| Turn-Off Fall Time | | t_f | -- | 24 | -- | |
| Source-Drain Diode (Note 4) | | | | | | |
| Forward On Voltage | $I_S = 0.6A, V_{GS} = 0V$ | V_{SD} | -- | 0.85 | 1.15 | V |

Notes:

1. Current limited by package
2. Pulse width limited by the maximum junction temperature
3. $L = 20\text{mH}, I_{AS} = 2.5A, V_{DD} = 50V, R_G = 25\Omega,$ Starting $T_J = 25^\circ\text{C}$
4. Pulse test: $PW \leq 300\mu s,$ duty cycle $\leq 2\%$
5. For DESIGN AID ONLY, not subject to production testing.
6. Switching time is essentially independent of operating temperature.

ORDERING INFORMATION

| PART NO. | PACKAGE | PACKING |
|-----------------|----------------|---------------------|
| TSM2N60SCW RPG | SOT-223 | 2,500pcs / 13" Reel |

Note:

1. Compliant to RoHS Directive 2011/65/EU and in accordance to WEEE 2002/96/EC
2. Halogen-free according to IEC 61249-2-21 definition

CHARACTERISTICS CURVES

($T_C = 25^\circ\text{C}$ unless otherwise noted)

Output Characteristics

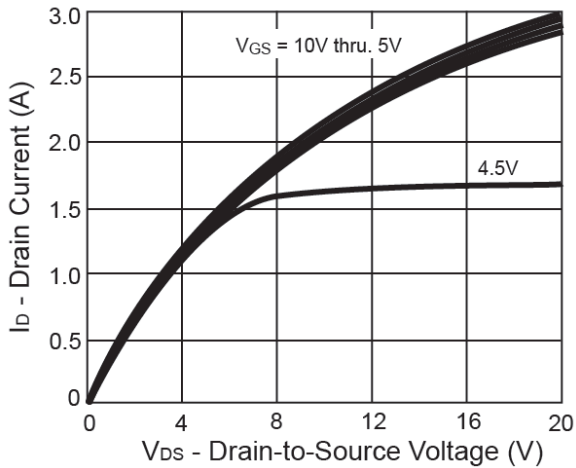

Transfer Characteristics

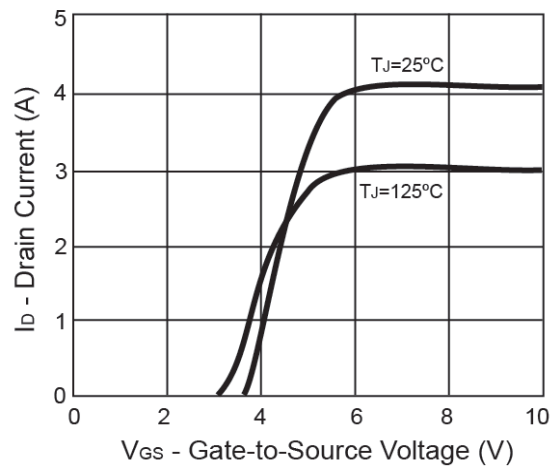

On-Resistance vs. Drain Current

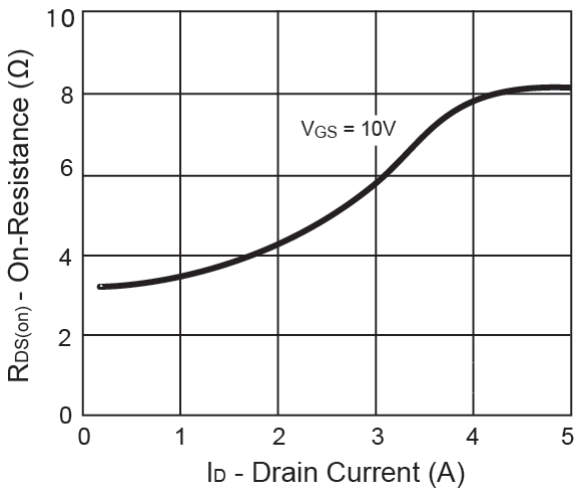

Gate Charge

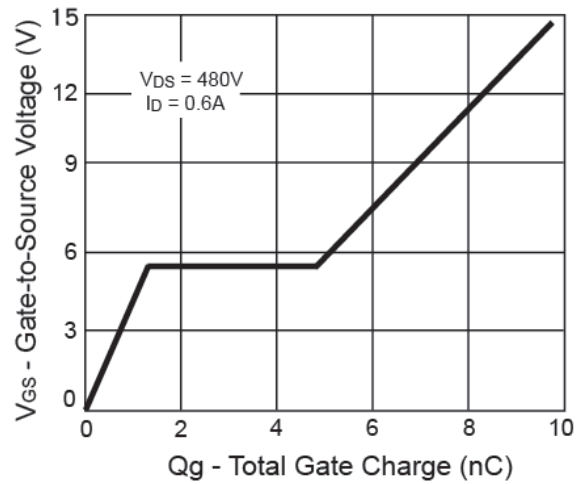

On-Resistance vs. Junction Temperature

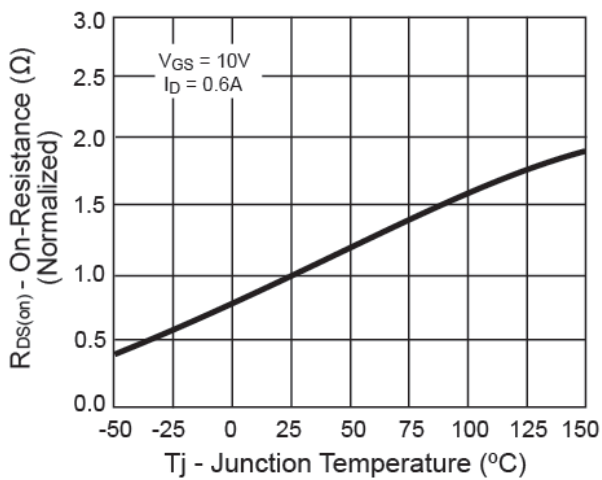

Source-Drain Diode Forward Voltage

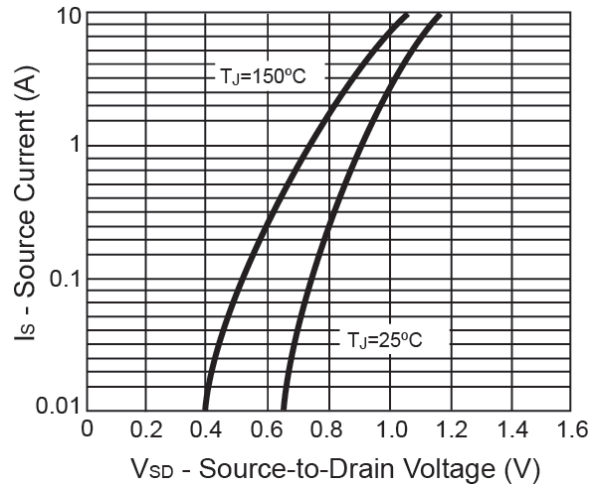

CHARACTERISTICS CURVES

(Tc = 25°C unless otherwise noted)

On-Resistance vs. Gate-Source Voltage

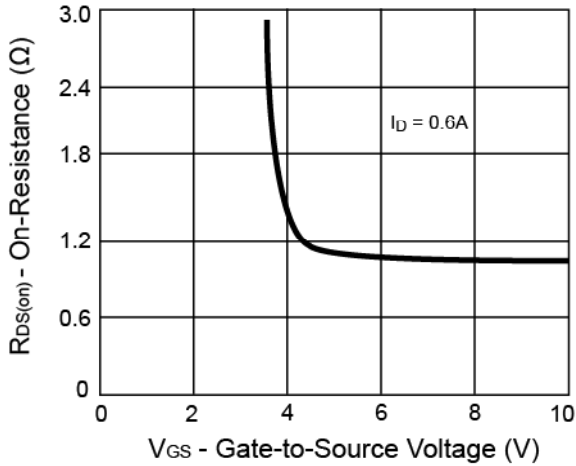

Threshold Voltage

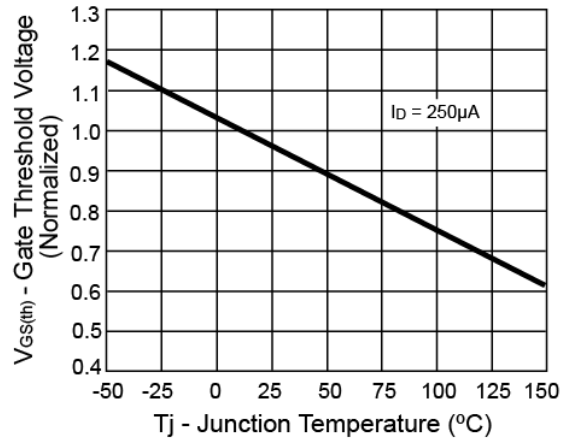

Maximum Safe Operating Area

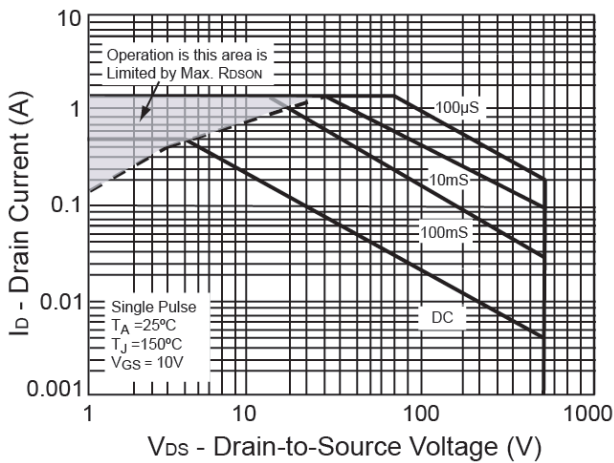

Normalized Thermal Transient Impedance, Junction-to-Ambient

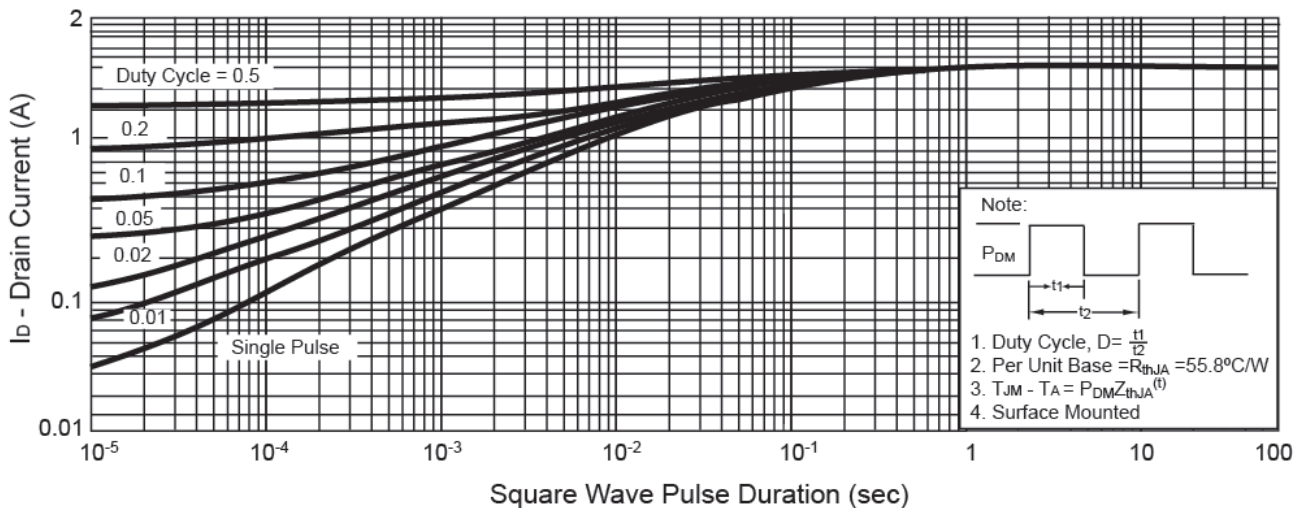

PACKAGE OUTLINE DIMENSIONS (Unit: Millimeters)

SOT-223

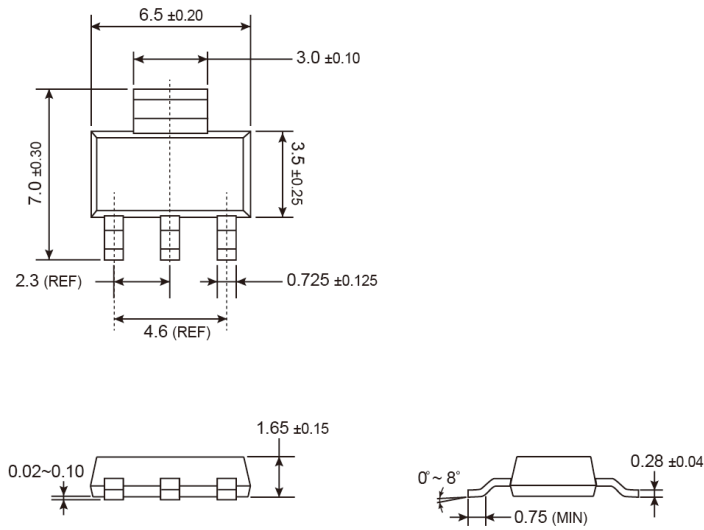

SUGGESTED PAD LAYOUT

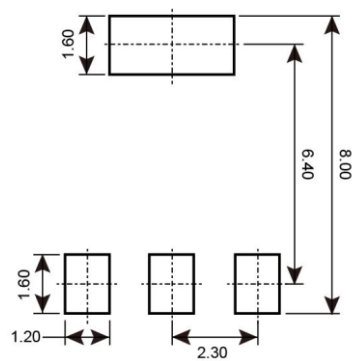

MARKING DIAGRAM

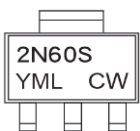

- Y** = Year Code
- M** = Month Code for Halogen Free Product
 - O** =Jan **P** =Feb **Q** =Mar **R** =Apr
 - S** =May **T** =Jun **U** =Jul **V** =Aug
 - W** =Sep **X** =Oct **Y** =Nov **Z** =Dec
- L** = Lot Code (1~9, A~Z)

Notice

Specifications of the products displayed herein are subject to change without notice. TSC or anyone on its behalf, assumes no responsibility or liability for any errors or inaccuracies.

Information contained herein is intended to provide a product description only. No license, express or implied, to any intellectual property rights is granted by this document. Except as provided in TSC's terms and conditions of sale for such products, TSC assumes no liability whatsoever, and disclaims any express or implied warranty, relating to sale and/or use of TSC products including liability or warranties relating to fitness for a particular purpose, merchantability, or infringement of any patent, copyright, or other intellectual property right.

The products shown herein are not designed for use in medical, life-saving, or life-sustaining applications. Customers using or selling these products for use in such applications do so at their own risk and agree to fully indemnify TSC for any damages resulting from such improper use or sale.