

Up to 0.8 A, up to 600 V sensitive standard SCR thyristor

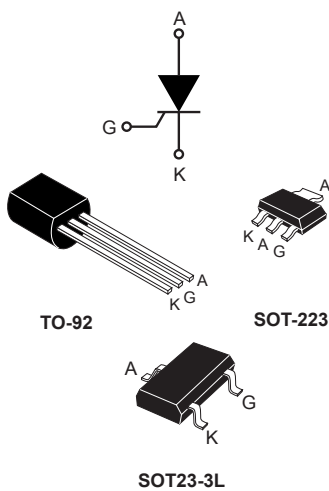

Features

- On-state rms current, $I_{T(RMS)}$ 0.8 A
- Repetitive peak off-state voltage up to 600 V
- Triggering gate current from 5 to 200 μ A
- ECOPACK2 compliant

Applications

- Gate driver for large Thyristors
- Overvoltage crowbar protection
- Ground fault circuit interrupters
- Arc fault circuit interrupter
- Standby mode power supplies
- Residual current detector
- Smoke detectors
- DC 24/48 V proximity sensors
- Capacitive ignition circuit

Description

Thanks to highly sensitive triggering levels, the P010XX SCR series is suitable for all applications where available gate current is limited, such as ground fault circuit interrupters, pilot circuits in solid state relays, stand-by mode power supplies, smoke and alarm detectors.

Available in through-hole or surface mount packages, the voltage capability of this series has been upgraded since its introduction and is now available up to 600 V.

Product status link	
P010XX	
Product summary	
$I_{T(RMS)}$	up to 0.8 A
V_{DRM}/V_{RRM}	up to 600 V
I_{GT}	From 5 to 200 μ A
$T_{jmax.}$	125 °C

1 Characteristics

Table 1. Absolute maximum ratings (limiting values, P010xxA and P010xxN)

Symbol	Parameters			Value	Unit
$I_{T(RMS)}$	On-state RMS current (180° conduction angle)	TO-92	$T_L = 55\text{ °C}$	0.8	A
		SOT-223	$T_{amb} = 70\text{ °C}$		
$I_{T(AV)}$	Average on-state current (180° conduction angle)	TO-92	$T_L = 55\text{ °C}$	0.5	A
		SOT-223	$T_{amb} = 70\text{ °C}$		
I_{TSM}	Non repetitive surge peak on-state current, T_j initial = 25 °C	$t_p = 8.3\text{ ms}$	$T_j = 25\text{ °C}$	8	A
		$t_p = 10\text{ ms}$		7	
I^2t	I^2t value for fusing	$t_p = 10\text{ ms}$	$T_j = 25\text{ °C}$	0.24	A ² s
dl/dt	Critical rate of rise of on-state current $I_G = 2 \times I_{GT}$, $t_r \leq 100\text{ ns}$	F = 60 Hz	$T_j = 125\text{ °C}$	50	A/ μ s
I_{GM}	Peak gate current	$t_p = 20\text{ }\mu$ s	$T_j = 125\text{ °C}$	1	A
$P_{G(AV)}$	Average gate power dissipation		$T_j = 125\text{ °C}$	0.1	W
T_{stg}	Storage junction temperature range			-40 to +150	°C
T_j	Operating junction temperature range			-40 to +125	°C

Table 2. Absolute maximum ratings (limiting values, P010xxL)

Symbol	Parameters			Value	Unit
$I_{T(RMS)}$	On-state RMS current (180° conduction angle)		$T_{amb} = 36\text{ °C}$	0.25	A
$I_{T(AV)}$	Average on-state current (180° conduction angle)		$T_{amb} = 36\text{ °C}$	0.16	A
I_{TSM}	Non repetitive surge peak on-state current, T_j initial = 25 °C	$t_p = 8.3\text{ ms}$	$T_j = 25\text{ °C}$	7	A
		$t_p = 10\text{ ms}$		6	
I^2t	I^2t value for fusing	$t_p = 10\text{ ms}$	$T_j = 25\text{ °C}$	0.18	A ² s
dl/dt	Critical rate of rise of on-state current $I_G = 2 \times I_{GT}$, $t_r \leq 100\text{ ns}$	F = 60 Hz	$T_j = 125\text{ °C}$	50	A/ μ s
I_{GM}	Peak gate current	$t_p = 20\text{ }\mu$ s	$T_j = 125\text{ °C}$	0.5	A
$P_{G(AV)}$	Average gate power dissipation		$T_j = 125\text{ °C}$	0.02	W
T_{stg}	Storage junction temperature range			-40 to +150	°C
T_j	Operating junction temperature range			-40 to +125	°C

Table 3. Electrical characteristics ($T_j = 25\text{ }^\circ\text{C}$, unless otherwise specified, P010xxA and P010xxN)

Symbol	Parameters		Value	Unit
I_{GT}	$V_D = 12\text{ V}, R_L = 140\ \Omega$	Max.	200	μA
V_{GT}		Max.	0.8	V
V_{GD}	$V_D = V_{DRM}, R_{GK} = 1\text{ k}\Omega, T_j = 125\text{ }^\circ\text{C}$	Min.	0.1	V
V_{RG}	$I_{RG} = 10\ \mu\text{A}$	Min.	8	
I_H	$I_T = 50\text{ mA}, R_{GK} = 1\text{ k}\Omega$	Max.	5	mA
I_L	$I_G = 1\text{ mA}, R_{GK} = 1\text{ k}\Omega$	Max.	6	mA
dV/dt	$V_D = 67\% V_{DRM}, R_{GK} = 1\text{ k}\Omega, T_j = 125\text{ }^\circ\text{C}$	Min.	75	V/ μs

Table 4. Static electrical characteristics (P010xxA and P010xxN)

Symbol	Test conditions			Value	Unit
V_{TM}	$I_{TM} = 1.6\text{ A}, t_p = 380\ \mu\text{s}$	$25\text{ }^\circ\text{C}$	Max.	1.95	V
V_{TO}	Threshold on-state voltage	$125\text{ }^\circ\text{C}$	Max.	0.95	V
R_d	Dynamic resistance	$125\text{ }^\circ\text{C}$	Max.	600	m Ω
I_{DRM} I_{RRM}	$V_{DRM} = V_{RRM} = 400\text{ V}, R_{GK} = 1\text{ k}\Omega$	$25\text{ }^\circ\text{C}$	Max.	1	μA
	$V_{DRM} = V_{RRM} = 600\text{ V}, R_{GK} = 1\text{ k}\Omega$			10	
	$V_{DRM} = V_{RRM}, R_{GK} = 1\text{ k}\Omega$	$125\text{ }^\circ\text{C}$		100	

Table 5. Electrical characteristics ($T_j = 25\text{ }^\circ\text{C}$, unless otherwise specified, P010xxL)

Symbol	Parameters		P010 2xL	P010 9AL	Unit
I_{GT}	$V_D = 12\text{ V}, R_L = 140\ \Omega$	Max.	200	1	μA
V_{GT}		Max.	0.8		V
V_{GD}	$V_D = V_{DRM}, R_L = 3.3\text{ k}\Omega, R_{GK} = 1\text{ k}\Omega, T_j = 125\text{ }^\circ\text{C}$	Min.	0.1		V
V_{RG}	$I_{RG} = 10\ \mu\text{A}$	Min.	8		V
I_H	$I_T = 50\text{ mA}, R_{GK} = 1\text{ k}\Omega$	Max.	6		mA
I_L	$I_G = 1\text{ mA}, R_{GK} = 1\text{ k}\Omega$	Max.	7		mA
dV/dt	$V_D = 67\% V_{DRM}, R_{GK} = 1\text{ k}\Omega, T_j = 125\text{ }^\circ\text{C}$	Min.	200	100	V/ μs

Table 6. Static electrical characteristics (P010xxL)

Symbol	Test conditions		P010 2xL	P010 9AL	Unit
V_{TM}	$I_{TM} = 0.4 \text{ A}$, $t_p = 380 \mu\text{s}$, $T_j = 25 \text{ }^\circ\text{C}$	Max.		1.7	V
V_{TO}	Threshold on-state voltage, $T_j = 125 \text{ }^\circ\text{C}$	Max.		1.0	V
R_d	Dynamic resistance, $T_j = 125 \text{ }^\circ\text{C}$	Max.		1000	m Ω
I_{DRM} I_{RRM}	$V_{DRM} = V_{RRM}$, $T_j = 25 \text{ }^\circ\text{C}$	Max.		1 100	μA

Table 7. Electrical device summary

Order code	Voltage				Sensitivity	Package	Packing mode
	100 V	200 V	400 V	600 V			
P0102AA 1AA3	X				200 μA	TO-92	Bulk
P0102AA 5AL3	X					TO-92	Tape and reel 13 inch
P0102AL 5AA4	X					SOT23-3L	Tape and reel 7 inch
P0102BA 1AA3		X				TO-92	Bulk
P0102BL 5AA4		X				SOT23-3L	Tape and reel 7 inch
P0102DN 5AA4	X		X			SOT-223	Tape and reel 7 inch
P0102MA 1AA3				X		TO-92	Bulk
P0102MN 5AA4				X		SOT-223	Tape and reel 7 inch
P0109AL 5AA4	X				1 μA	SOT23-3L	Tape and reel 7 inch
P0109DA 1AA3			X			TO-92	Bulk
P0109DA 5AL3			X			TO-92	Tape and reel 13 inch

Table 8. Thermal resistance

Symbol	Parameters	Max. value	Unit
$R_{th(j-a)}$	Junction to case (DC)TO-92	80	$^\circ\text{C/W}$
$R_{th(j-t)}$	Junction to ambient (DC)SOT-223	30	
$R_{th(j-a)}$	Junction to ambient (DC)TO-92	150	
	Junction to ambient (DC)	$S^{(1)} = 5 \text{ cm}^2$	
$R_{th(j-a)}$	Junction to ambient (mounted on FR4 with recommended pad layout)		

1. S = Copper surface under tab.

1.1 Characteristics (curves)

Figure 1. Maximum power dissipation versus on-state RMS current (full cycle)

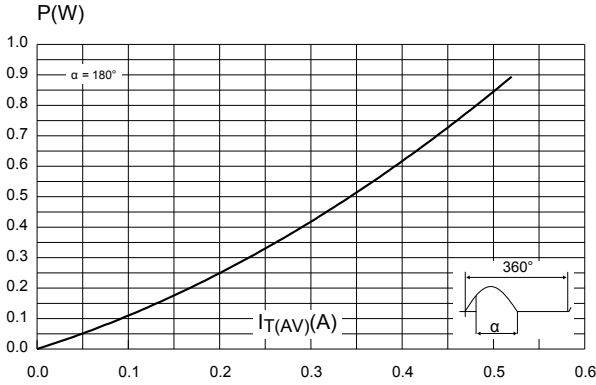

Figure 2. Maximum average power dissipation versus average on-state current P010xxL

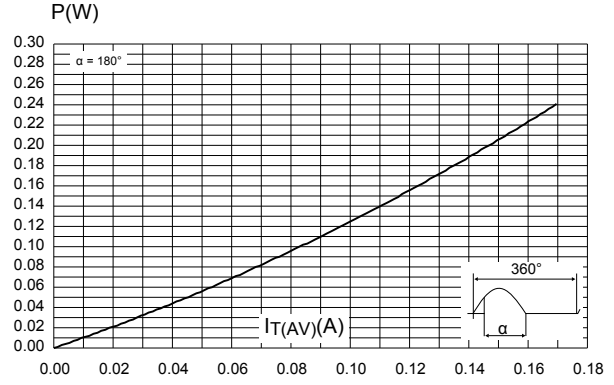

Figure 3. Average and DC on-state current versus lead temperature P010xxA and P010xxN

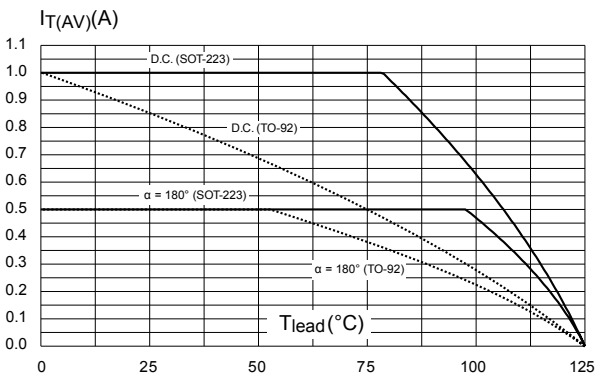

Figure 4. Average and DC on-state current versus ambient temperature P010xxA and P010xxN

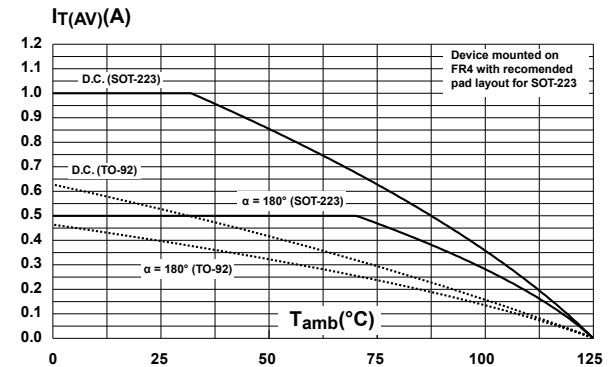

Figure 5. Average and DC on-state current versus case temperature P010xxL

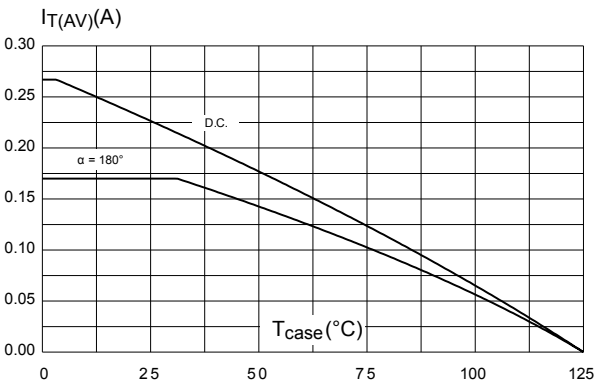
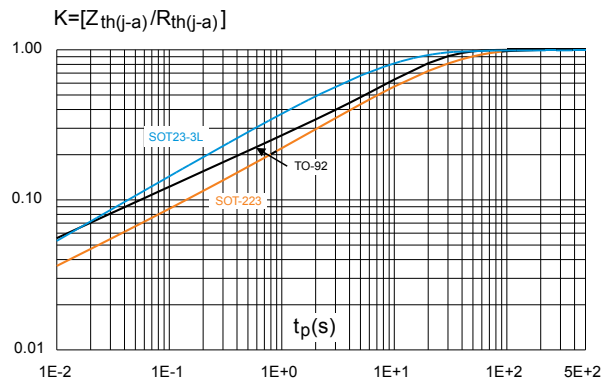

Figure 6. Relative variation of thermal impedance junction to ambient versus pulse duration



Prerelease product(s)

Figure 7. Gate trigger, holding, and latching currents with gate trigger voltage versus junction temperature

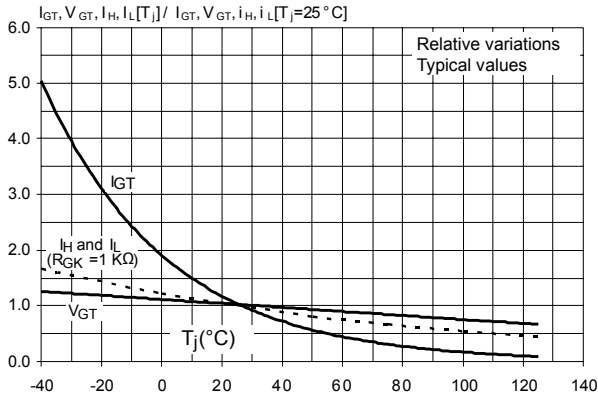

Figure 8. Relative variation of holding current versus gate-cathode resistance

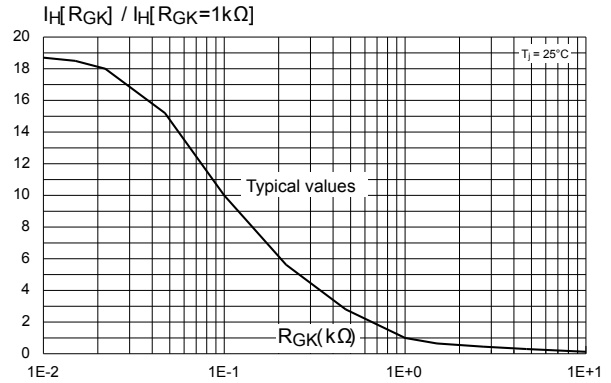

Figure 9. Relative variation of static dV/dt immunity versus gate-cathode resistance (typical values)

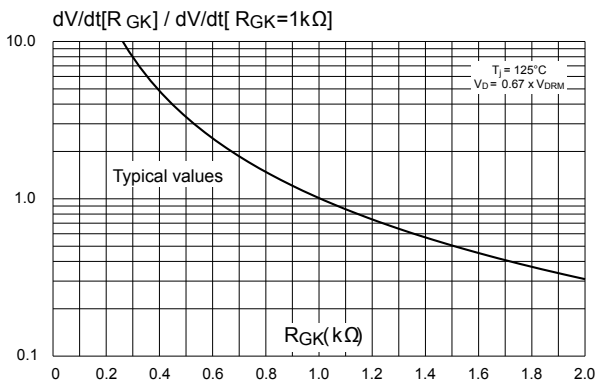

Figure 10. Relative variation of static dV/dt immunity versus gate-cathode capacitance

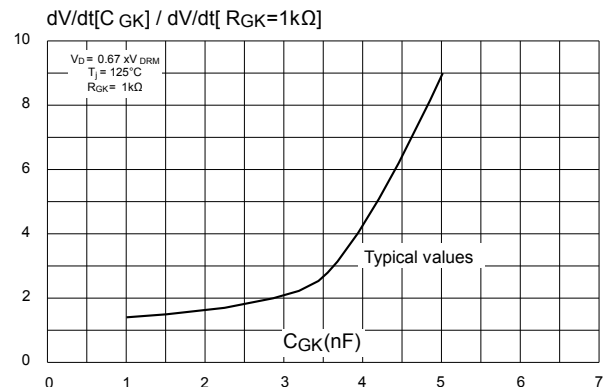

Figure 11. Surge peak on-state current versus number of cycles

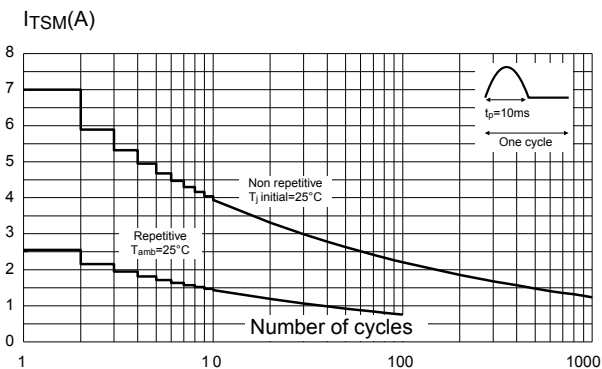
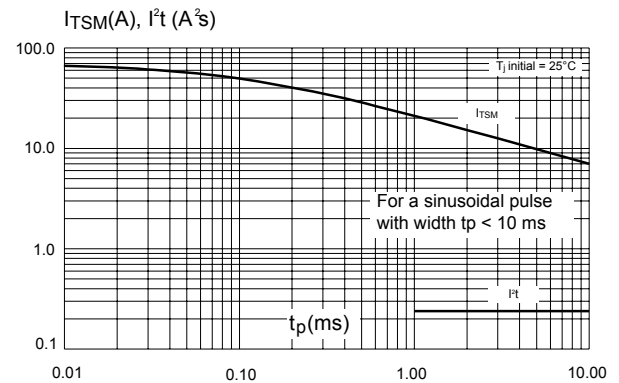

Figure 12. Non-repetitive surge peak on-state current for sinusoidal pulse (tp < 10 ms)



Prerelease product(s)

Figure 13. On-state characteristics P010xxA, P010xxN

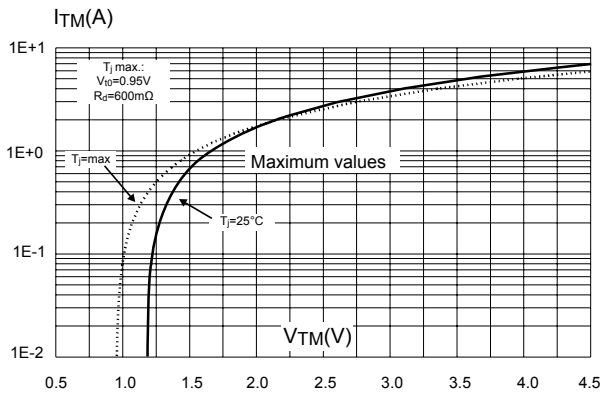

Figure 14. On-state characteristics P010xxL

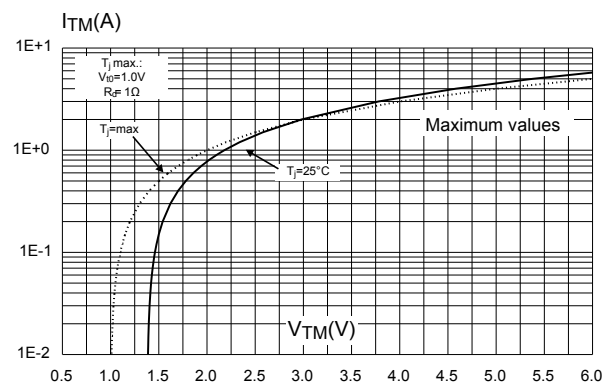

Figure 15. Thermal resistance junction to ambient versus copper surface under tab P010xxN

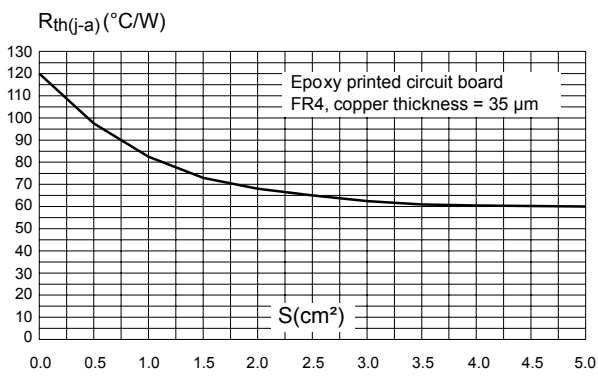
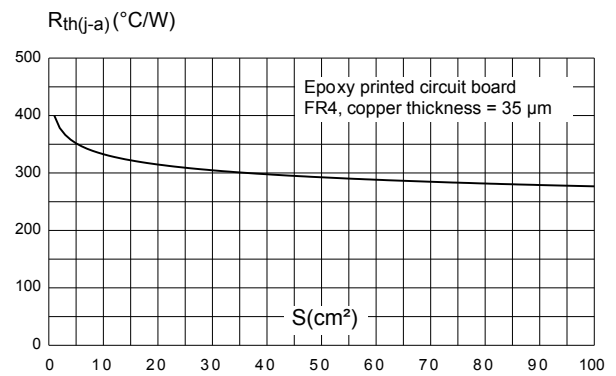

Figure 16. Thermal resistance junction to ambient versus copper surface under tab P010xxL



Prerelease product(s)

2 Package information

In order to meet environmental requirements, ST offers these devices in different grades of **ECOPACK** packages, depending on their level of environmental compliance. ECOPACK specifications, grade definitions and product status are available at: www.st.com. ECOPACK is an ST trademark.

2.1 TO-92 package information

- Lead free plating + halogen-free molding resin
- Epoxy meets UL94, V0

Figure 17. TO-92 package outline

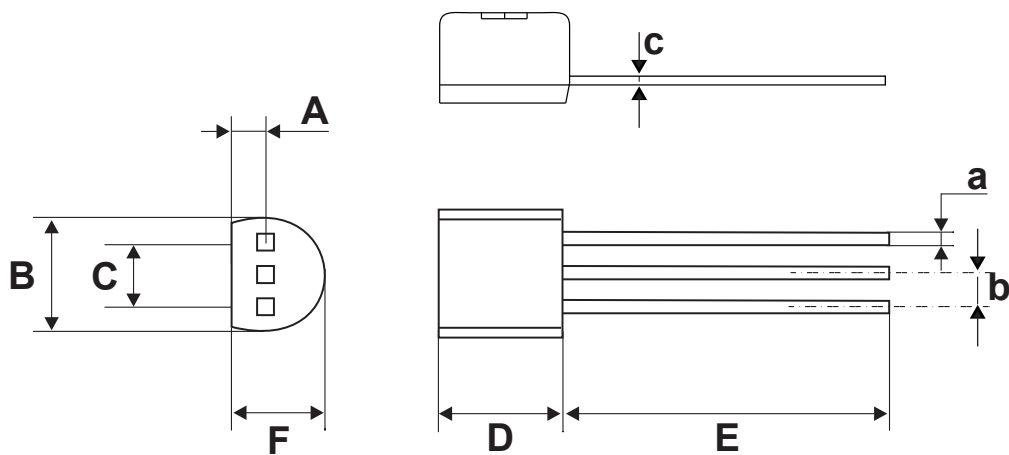

Table 9. TO-92 package mechanical data

Ref.	Dimensions					
	Millimeters			Inches ⁽¹⁾		
	Min.	Typ.	Max.	Min.	Typ.	Max.
A		1.35			0.0531	
B			4.70			0.1850
C		2.54			0.1000	
D	4.40			0.1732		
E	12.70			0.5000		
F			3.70			0.1457
a			0.50			0.0197
b		1.27			0.500	
c			0.48			0.0189

1. Inches dimensions given for information

2.2 SOT-223 package information

- Epoxy meets UL94, V0
- Lead free plating + halogen-free molding resin

Figure 18. SOT-223 package outline

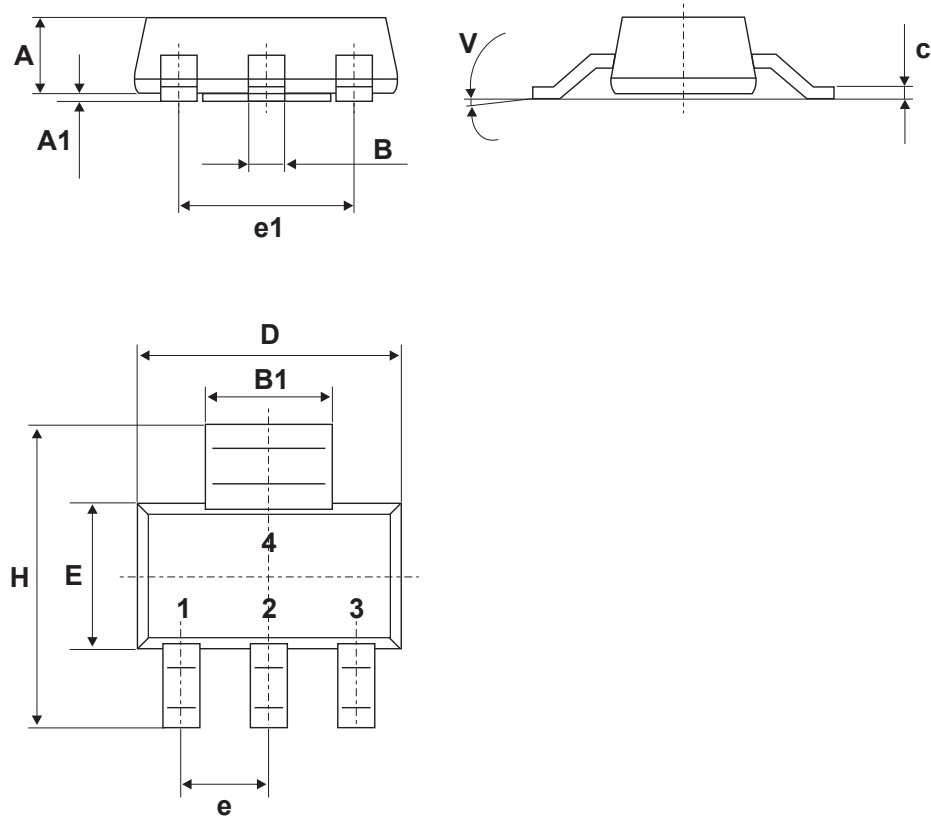

Prerelease product(s)

Table 10. SOT-223 package mechanical data

Ref.	Dimensions					
	Millimeters			Inches ⁽¹⁾		
	Min.	Typ.	Max.	Min.	Typ.	Max.
A			1.80			0.0709
A1		0.02	0.10		0.0008	0.0039
B	0.60	0.70	0.85	0.024	0.0276	0.0335
B1	2.90	3.00	3.15	0.114	0.1181	0.1240
c	0.24	0.26	0.35	0.009	0.0102	0.0138
D	6.30	6.50	6.70	0.248	0.2559	0.2638
e		2.3			0.0906	
e1		4.6			0.1811	
E	3.30	3.50	3.70	0.130	0.1378	0.1457
H	6.70	7.00	7.30	0.264	0.2756	0.2874
V	10° max.					

1. Inches only for reference

Figure 19. SOT-223 footprint (dimensions in mm)

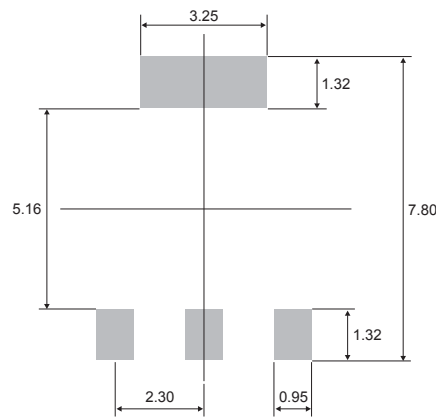

Prerelease product(s)

2.3 SOT23-3L package information

Figure 20. SOT23-3L package outline

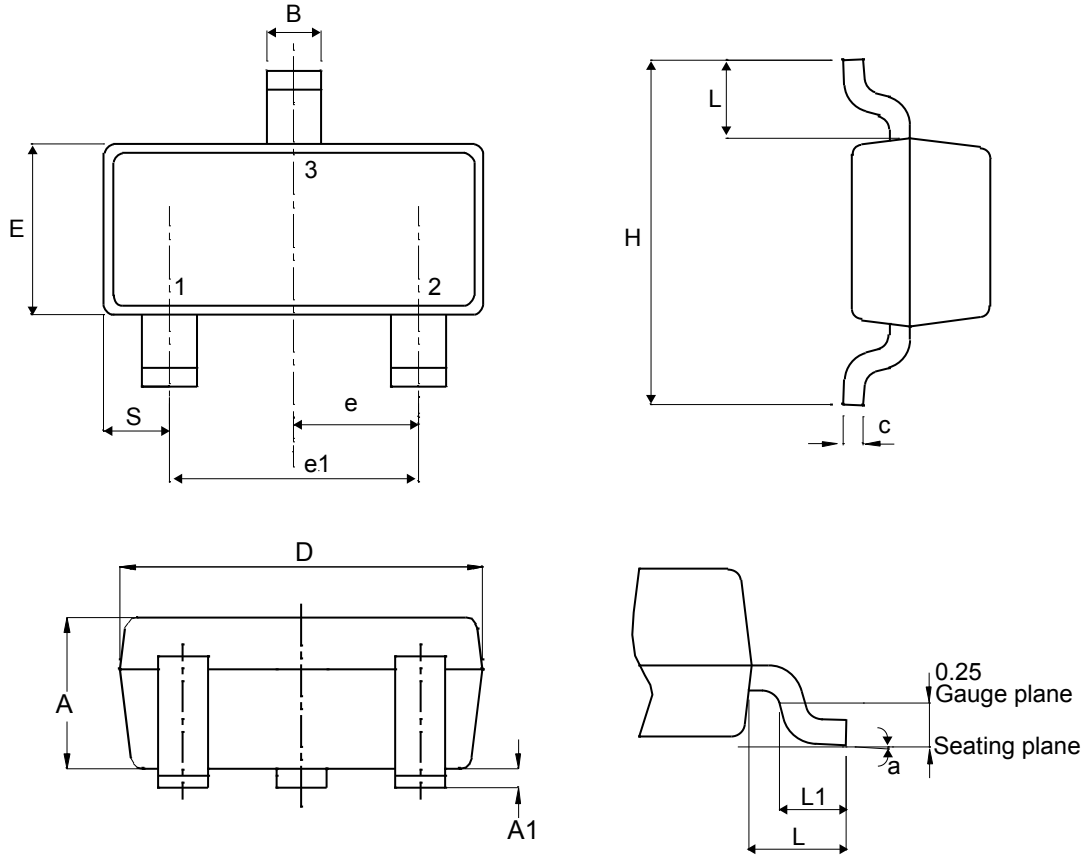

Prerelease product(s)

Table 11. SOT23-3L package mechanical data

Ref.	Dimensions					
	Millimeters			Inches (for reference only)		
	Min.	Typ.	Max.	Min.	Typ.	Max.
A	0.89		1.40	0.0350		0.0551
A1	0.00		0.10	0.0000		0.0039
B	0.30		0.51	0.0118		0.0201
C	0.085		0.18	0.0033		0.0071
D	2.75		3.04	0.1083		0.1197
e	0.85		1.05	0.0335		0.0413
e1	1.70		2.10	0.0669		0.0827
E	1.20		1.75	0.0472		0.0689
H	2.10		3.00	0.0827		0.1181
L		0.60			0.0236	
S	0.35		0.65	0.0138		0.256
L1	0.25		0.55	0.0098		0.0217
a	0°		8°	0°		8°

Figure 21. SOT23-3L footprint in mm

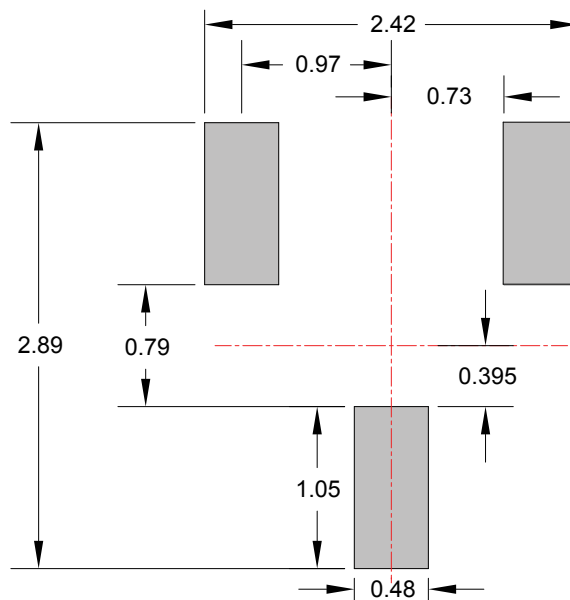

Prerelease product(s)

3 Ordering information

Figure 22. Ordering information scheme

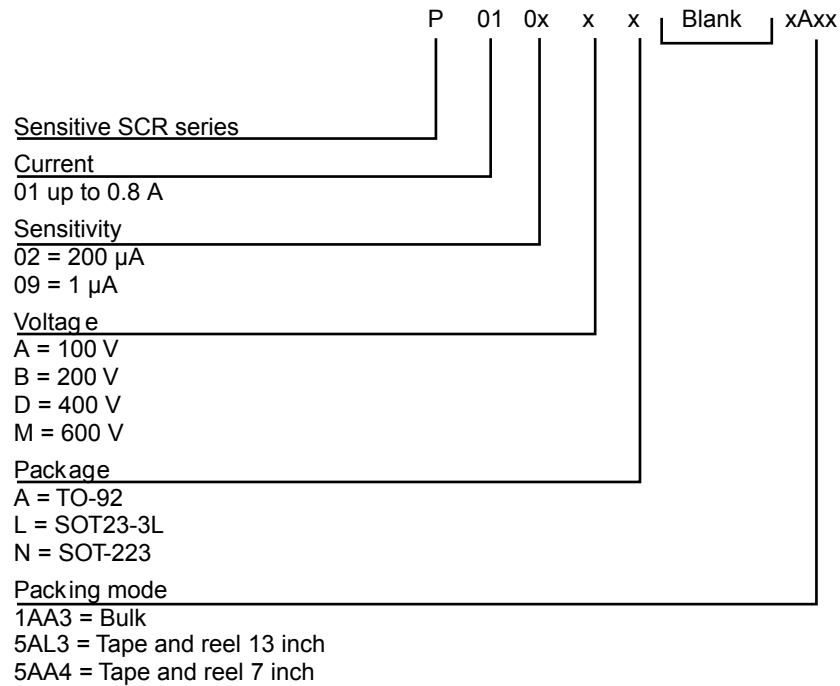

Table 12. Ordering information

Order code	Marking	Package	Weight	Base qty.	Delivery mode
P0102AA 1AA3	P0102 AA	TO-92	0.2 g	2500	Bulk
P0102AA 5AL3	P0102 AA	TO-92	0.2 g	2000	Tape and reel 13 inch
P0102AL 5AA4	P2A	SOT23-3L	0.01 g	3000	Tape and reel 7 inch
P0102BA 1AA3	P0102 BA	TO-92	0.2 g	1000	Bulk
P0102BL 5AA4	P2B	SOT23-3L	0.01 g	3000	Tape and reel 7 inch
P0102DN 5AA4	P2D	SOT-223	0.11 g	3000	Tape and reel 7 inch
P0102MA 1AA3	P0102 MA	TO-92	0.2 g	2500	Bulk
P0102MN 5AA4	P2M	SOT-223	0.11 g	2000	Tape and reel 7 inch
P0109AL 5AA4	P9A	SOT23-3L	0.01 g	3000	Tape and reel 7 inch
P0109DA 1AA3	P0109 DA	TO-92	0.2 g	2500	Bulk
P0109DA 5AL3	P0109 DA	TO-92	0.2 g	2000	Tape and reel 13 inch

Prerelease product(s)

Revision history

Table 13. Document revision history

Date	Revision	Changes
24-Nov-2008	1	First issue.
01-Apr-2014	2	Added V_{GT} in Figure 7, updated Figure 11 and Table 9 and reformatted to current standard.
23-Sep-2019	3	Removed P0102DA information.

IMPORTANT NOTICE – PLEASE READ CAREFULLY

STMicroelectronics NV and its subsidiaries (“ST”) reserve the right to make changes, corrections, enhancements, modifications, and improvements to ST products and/or to this document at any time without notice. Purchasers should obtain the latest relevant information on ST products before placing orders. ST products are sold pursuant to ST’s terms and conditions of sale in place at the time of order acknowledgement.

Purchasers are solely responsible for the choice, selection, and use of ST products and ST assumes no liability for application assistance or the design of Purchasers’ products.

No license, express or implied, to any intellectual property right is granted by ST herein.

Resale of ST products with provisions different from the information set forth herein shall void any warranty granted by ST for such product.

ST and the ST logo are trademarks of ST. For additional information about ST trademarks, please refer to www.st.com/trademarks. All other product or service names are the property of their respective owners.

Information in this document supersedes and replaces information previously supplied in any prior versions of this document.

© 2019 STMicroelectronics – All rights reserved