

CURRENT SENSING SINGLE CHANNEL DRIVER

Features

- Floating channel designed for bootstrap operation
Fully operational to +600V
Tolerant to negative transient voltage dV/dt immune
- Application- specific gate drive range:
Motor Drive: 12 to 20V (IR2127/IR2128)
Automotive: 9 to 20V (IR21271)
- Undervoltage lockout
- 3.3V, 5V and 15V input logic compatible
- FAULT lead indicates shutdown has occurred
- Output in phase with input (IR2127/IR21271)
- Output out of phase with input (IR2128)
- Available in Lead-Free

Description

The IR2127/IR2128/IR21271(S) is a high voltage, high speed power MOSFET and IGBT driver. Proprietary HVIC and latch immune CMOS technologies enable ruggedized monolithic construction. The logic input is compatible with standard CMOS or LSTTL outputs, down to 3.3V. The protection circuitry detects over-current in the driven power transistor and terminates the gate drive voltage. An open drain FAULT signal is provided to indicate that an over-current shutdown has occurred. The output driver features a high pulse current buffer stage designed for minimum cross-conduction. The floating channel can be used to drive an N-channel power MOSFET or IGBT in the high side or low side configuration which operates up to 600 volts.

Product Summary

V_{OFFSET}	600V max.	
I_{O+/-}	200 mA / 420 mA	
V_{OUT}	12 - 20V (IR2127/IR2128)	9 - 20V (IR21271)
V_{csth}	250 mV or 1.8V	
t_{on/off} (typ.)	200 & 150 ns	

Packages

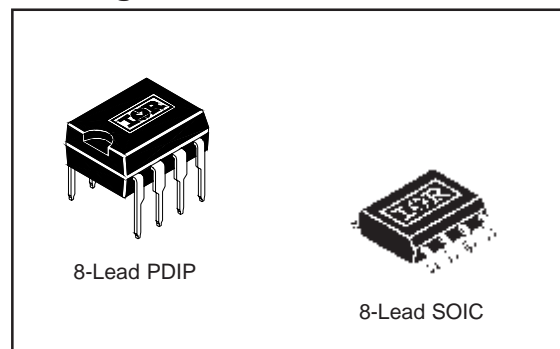

Typical Connection

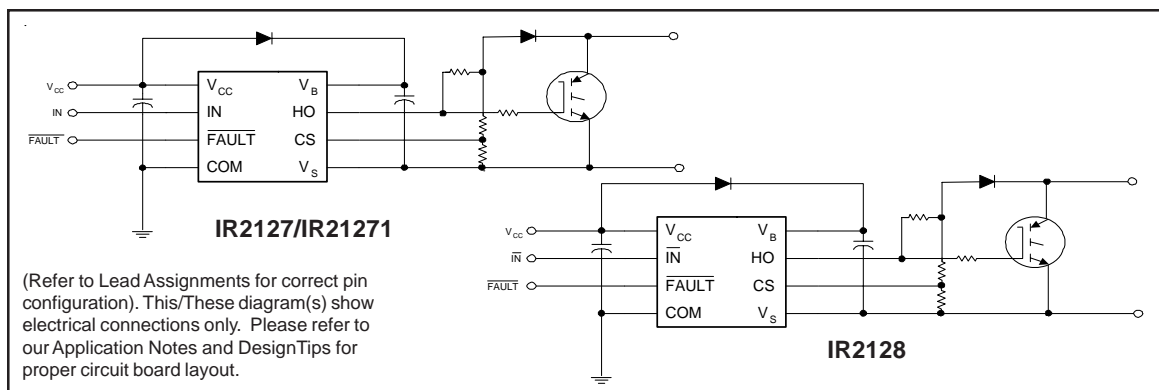

Absolute Maximum Ratings

Absolute Maximum Ratings indicate sustained limits beyond which damage to the device may occur. All voltage parameters are absolute voltages referenced to COM. The Thermal Resistance and Power Dissipation ratings are measured under board mounted and still air conditions.

Symbol	Definition	Min.	Max.	Units
V _B	High Side Floating Supply Voltage	-0.3	625	V
V _S	High Side Floating Offset Voltage	V _B - 25	V _B + 0.3	
V _{HO}	High Side Floating Output Voltage	V _S - 0.3	V _B + 0.3	
V _{CC}	Logic Supply Voltage	-0.3	25	
V _{IN}	Logic Input Voltage	-0.3	V _{CC} + 0.3	
V _{FLT}	$\overline{\text{FAULT}}$ Output Voltage	-0.3	V _{CC} + 0.3	
V _{CS}	Current Sense Voltage	V _S - 0.3	V _B + 0.3	
dV _S /dt	Allowable Offset Supply Voltage Transient	—	50	V/ns
P _D	Package Power Dissipation @ T _A ≤ +25°C (8 Lead DIP)	—	1.0	W
	(8 Lead SOIC)	—	0.625	
R _{thJA}	Thermal Resistance, Junction to Ambient (8 Lead DIP)	—	125	°C/W
	(8 Lead SOIC)	—	200	
T _J	Junction Temperature	—	150	°C
T _S	Storage Temperature	-55	150	
T _L	Lead Temperature (Soldering, 10 seconds)	—	300	

Recommended Operating Conditions

The Input/Output logic timing diagram is shown in Figure 1. For proper operation the device should be used within the recommended conditions. The V_S offset rating is tested with all supplies biased at 15V differential.

Symbol	Definition	Min.	Max.	Units
V _B	High Side Floating Supply Voltage (IR2127/IR2128)	V _S + 12	V _S + 20	V
	(IR21271)	V _S + 9	V _S + 20	
V _S	High Side Floating Offset Voltage	Note 1	600	
V _{HO}	High Side Floating Output Voltage	V _S	V _B	
V _{CC}	Logic Supply Voltage	10	20	
V _{IN}	Logic Input Voltage	0	V _{CC}	
V _{FLT}	$\overline{\text{FAULT}}$ Output Voltage	0	V _{CC}	
V _{CS}	Current Sense Signal Voltage	V _S	V _S + 5	
T _A	Ambient Temperature	-40	125	°C

Note 1: Logic operational for V_S of -5 to +600V. Logic state held for V_S of -5V to -V_{BS}. (Please refer to the Design Tip DT97-3 for more details).

Dynamic Electrical Characteristics

V_{BIAS} (V_{CC} , V_{BS}) = 15V, C_L = 1000 pF and T_A = 25°C unless otherwise specified. The dynamic electrical characteristics are measured using the test circuit shown in Figure 3.

Symbol	Definition	Min.	Typ.	Max.	Units	Test Conditions
t_{on}	Turn-On Propagation Delay	—	200	250	ns	$V_S = 0V$
t_{off}	Turn-Off Propagation Delay	—	150	200		$V_S = 600V$
t_r	Turn-On Rise Time	—	80	130		
t_f	Turn-Off Fall Time	—	40	65		
t_{bl}	Start-Up Blanking Time	500	700	900		
t_{cs}	CS Shutdown Propagation Delay	—	240	360		
t_{fit}	CS to FAULT Pull-Up Propagation Delay	—	340	510		

Static Electrical Characteristics

V_{BIAS} (V_{CC} , V_{BS}) = 15V and T_A = 25°C unless otherwise specified. The V_{IH} , V_{TH} and I_{IN} parameters are referenced to COM. The V_O and I_O parameters are referenced to V_S .

Symbol	Definition	Min.	Typ.	Max.	Units	Test Conditions
V_{IH}	Logic "1" Input Voltage (IR2127/IR21271)	3.0	—	—	V	$V_{CC} = 10V$ to 20V
V_{IL}	Logic "0" Input Voltage (IR2128)	—	—	0.8		
V_{IL}	Logic "0" Input Voltage (IR2127/IR21271)	—	—	0.8	mV	
V_{CS+}	Logic "1" Input Voltage (IR2128)	—	—	0.8		
V_{CSTH+}	CS Input Positive Going Threshold (IR2127/IR2128)	180	250	320	V	
V_{CSTH+}	CS Input Positive Going Threshold (IR21271)	—	1.8	—		
V_{OH}	High Level Output Voltage, $V_{BIAS} - V_O$	—	—	100	mV	$I_O = 0A$
V_{OL}	Low Level Output Voltage, V_O	—	—	100		$I_O = 0A$
I_{LK}	Offset Supply Leakage Current	—	—	50	μA	$V_B = V_S = 600V$
I_{QBS}	Quiescent V_{BS} Supply Current	—	200	400		$V_{IN} = 0V$ or 5V
I_{QCC}	Quiescent V_{CC} Supply Current	—	60	120		$V_{IN} = 5V$
I_{IN+}	Logic "1" Input Bias Current	—	7.0	15		$V_{IN} = 0V$
I_{IN-}	Logic "0" Input Bias Current	—	—	1.0		$V_{CS} = 3V$
I_{CS+}	"High" CS Bias Current	—	—	1.0		$V_{CS} = 0V$
I_{CS-}	"High" CS Bias Current	—	—	1.0		
V_{BSUV+}	V_{BS} Supply Undervoltage Positive Going Threshold (IR2127/IR2128)	8.8	10.3	11.8		V
V_{BSUV+}	V_{BS} Supply Undervoltage Positive Going Threshold (IR21271)	6.3	7.2	8.2		
V_{BSUV-}	V_{BS} Supply Undervoltage Negative Going Threshold (IR2127/IR2128)	7.5	9.0	10.6	V	
V_{BSUV-}	V_{BS} Supply Undervoltage Negative Going Threshold (IR21271)	6.0	6.8	7.7		
I_{O+}	Output High Short Circuit Pulsed Current	200	250	—	mA	$V_O = 0V$, $V_{IN} = 5V$ $PW \leq 10 \mu s$
I_{O-}	Output Low Short Circuit Pulsed Current	420	500	—		$V_O = 15V$, $V_{IN} = 0V$ $PW \leq 10 \mu s$
Ron, FLT	FAULT - Low on Resistance	—	125	—	Ω	

Functional Block Diagram IR2127/IR21271

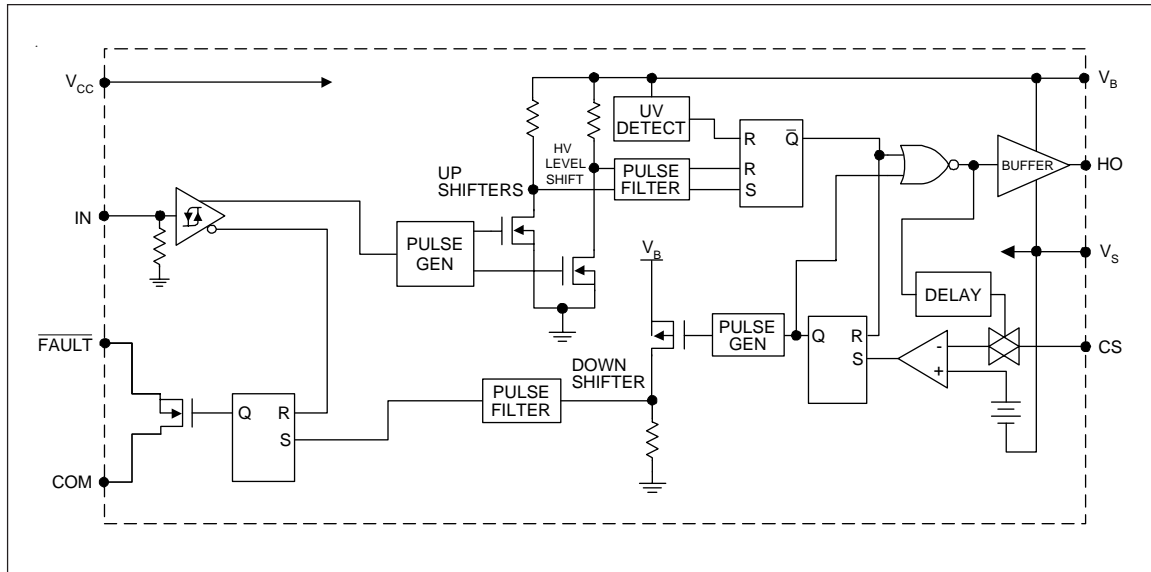

Functional Block Diagram IR2128

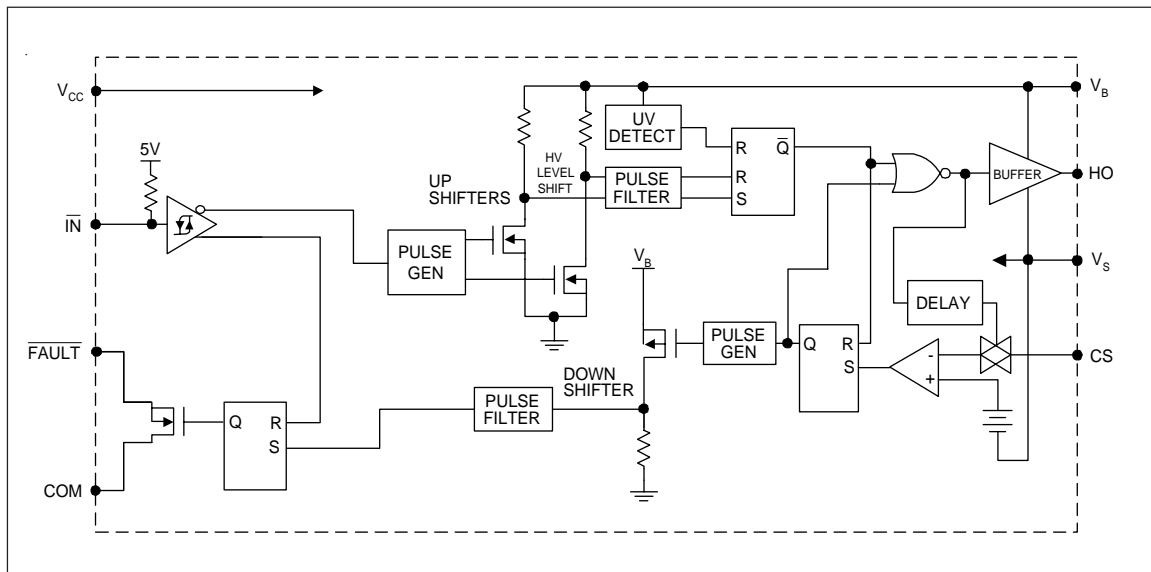

Lead Definitions

Symbol	Description
V _{CC}	Logic and gate drive supply
IN	Logic input for gate driver output (HO), in phase with HO (IR2127/IR21271) out of phase with HO (IR2128)
$\overline{\text{FAULT}}$	Indicates over-current shutdown has occurred, negative logic
COM	Logic ground
V _B	High side floating supply
HO	High side gate drive output
V _S	High side floating supply return
CS	Current sense input to current sense comparator

Lead Assignments

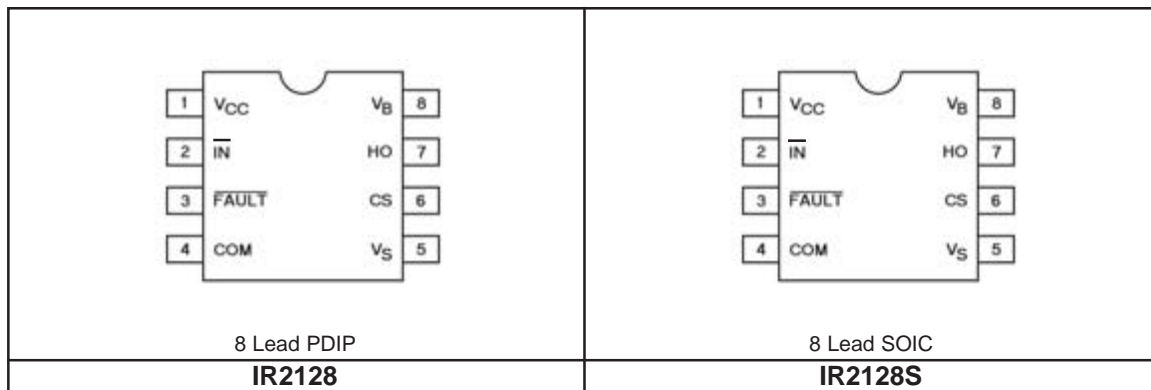
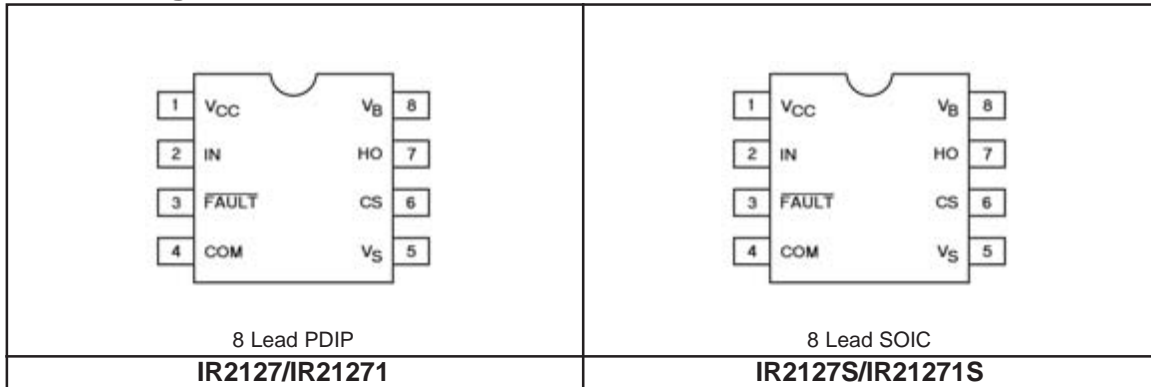

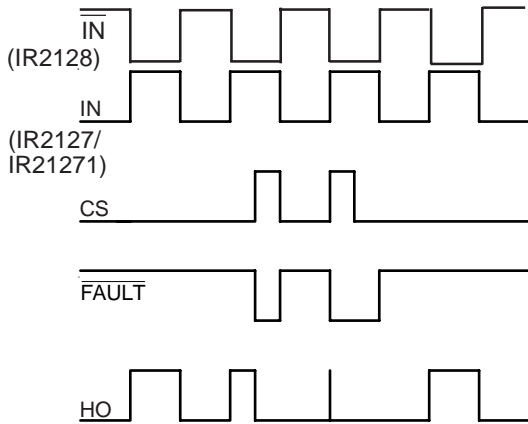

Figure 1. Input/Output Timing Diagram

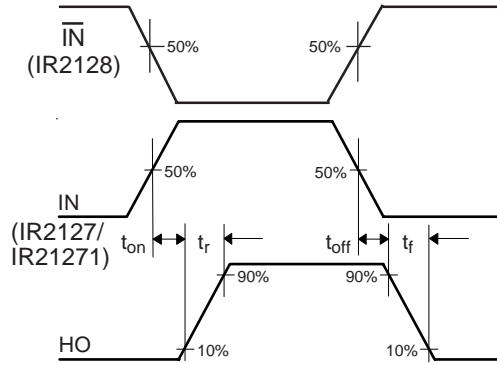

Figure 2. Switching Time Waveform Definition

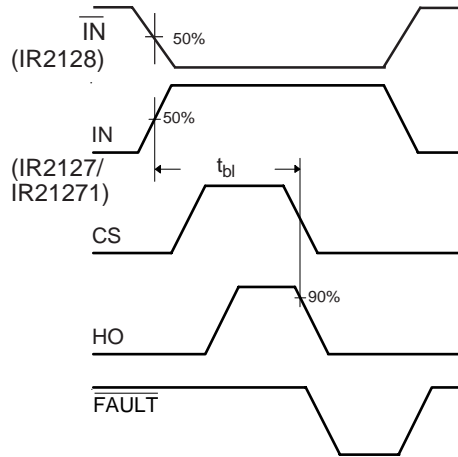

Figure 3. Start-up Blanking Time Waveform Definitions

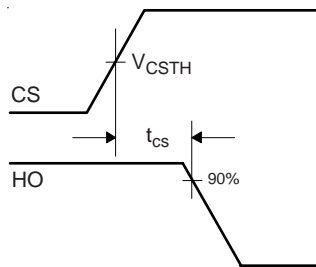

Figure 4. CS Shutdown Waveform Definitions

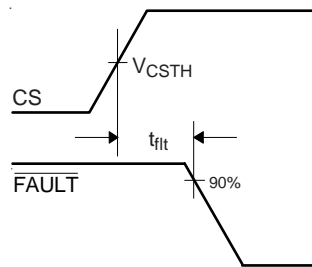

Figure 5. CS to FAULT Waveform Definitions

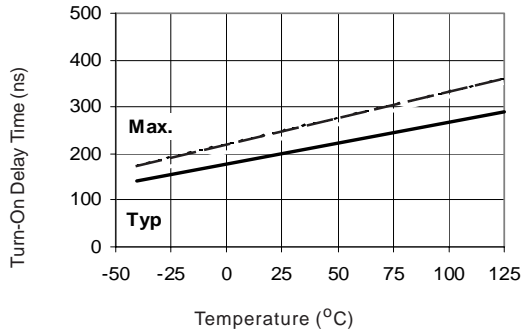

Figure 10A Turn-On Time vs. Temperature

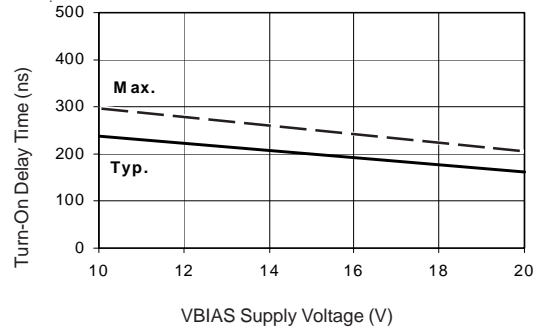

Figure 10B Turn-On Time vs. Supply Voltage

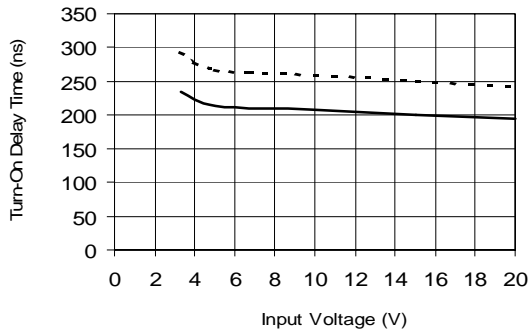

Figure 10C Turn-On Time vs. Input Voltage

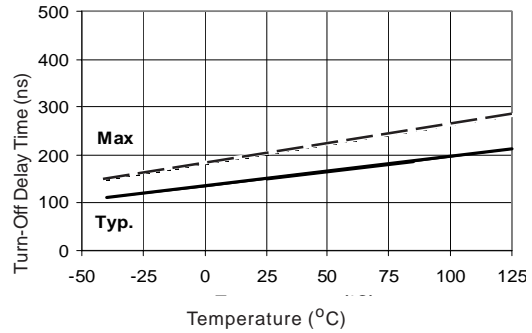

Figure 11A Turn-Off Time vs. Temperature

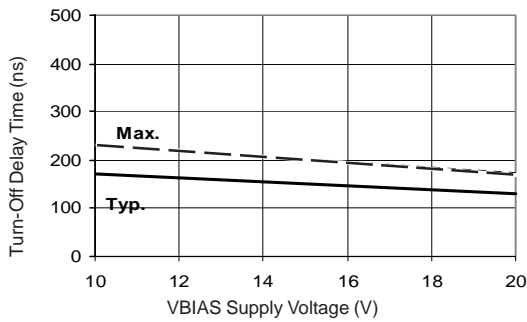

Figure 11B Turn-Off Time vs. Supply Voltage

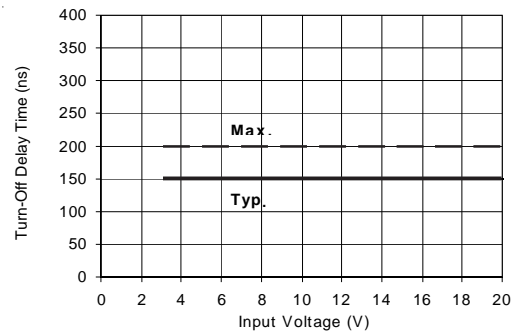

Figure 11C Turn-Off Time vs. Input Voltage

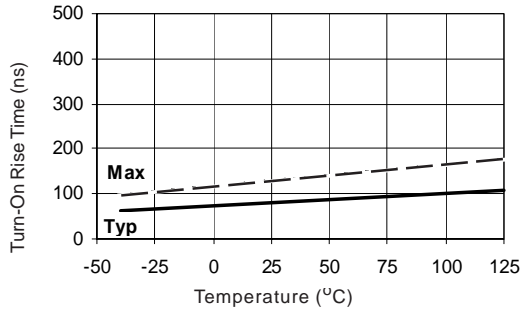

Figure 12A Turn-On Rise Time vs. Temperature

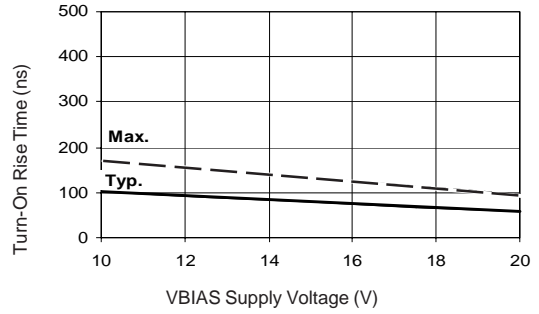

Figure 12B Turn-On Rise Time vs. Supply Voltage

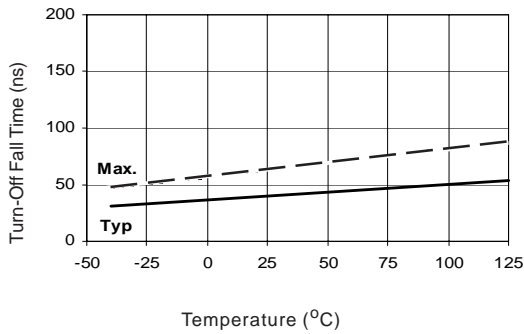

Figure 13A Turn-Off Fall Time vs. Temperature

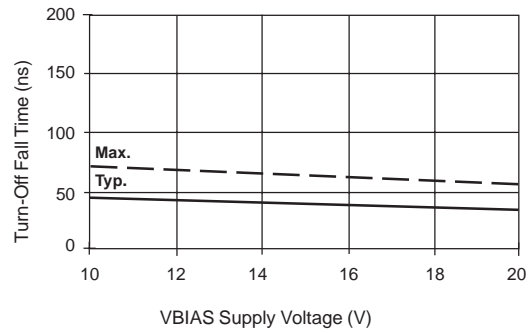

Figure 13B Turn-Off Fall Time vs. Voltage

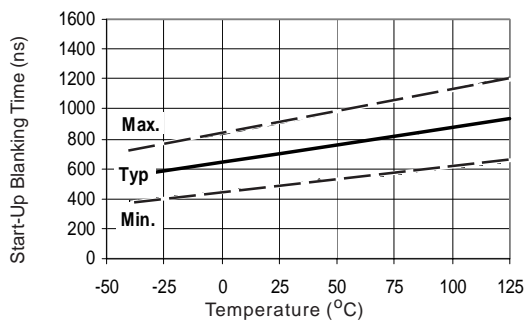

Figure 14A Start-Up Blanking Time vs. Temperature

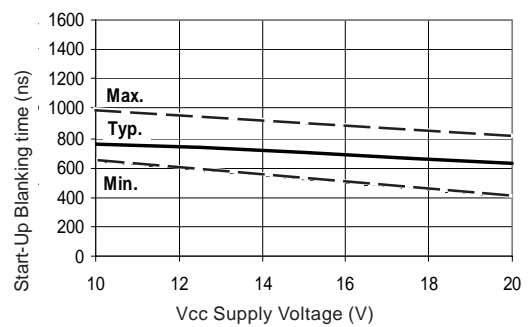

Figure 14B Start-Up Blanking Time vs Voltage

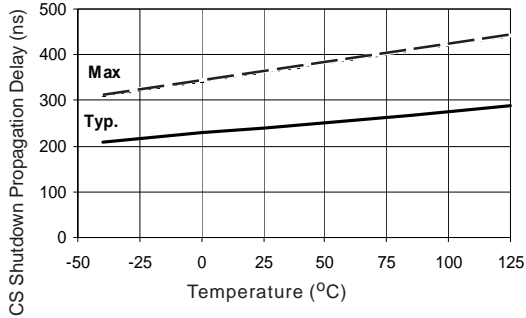

Figure 15A CS Shutdown Propagation Delay vs. Temperature

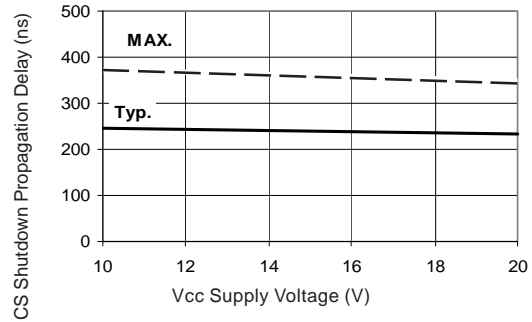

Figure 15B CS Shutdown Propagation Delay vs. Voltage

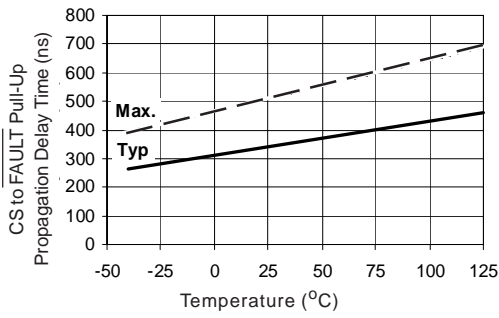

Figure 16A CS to $\overline{\text{FAULT}}$ Pull-Up Propagation Delay vs. Temperature

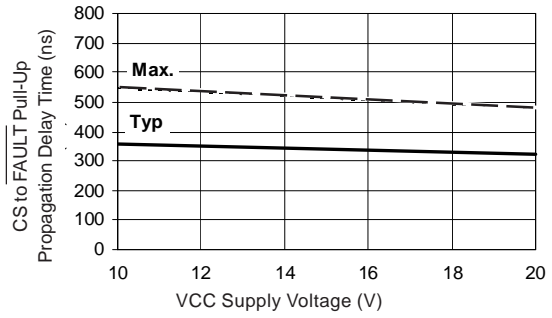

Figure 16B CS to $\overline{\text{FAULT}}$ Pull-Up Propagation Delay vs. Voltage

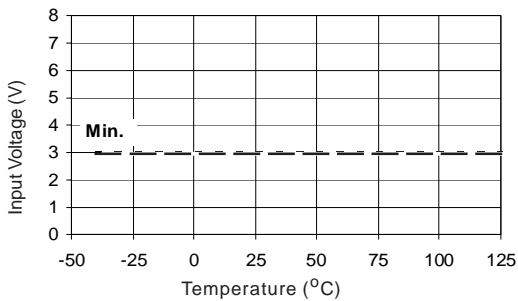

Figure 17A Logic "1" Input Voltage (IR2127)
Logic "0" Input Voltage (IR2128)
vs Temperature

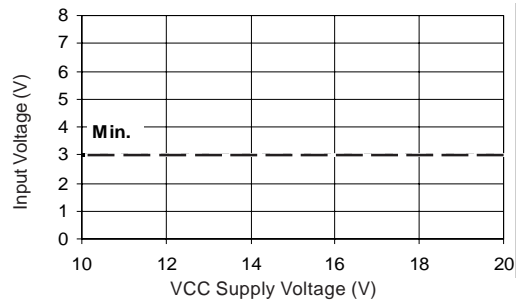

Figure 17B Logic "1" Input Voltage (IR2127)
Logic "0" Input Voltage (IR2128)
vs Voltage

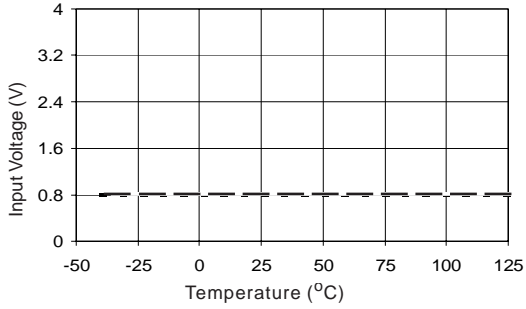

Figure 18A Logic "0" Input Voltage (IR2127)
Logic "1" Input Voltage (IR2128)
vs Temperature

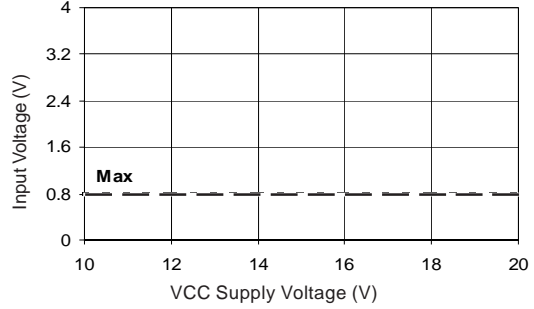

Figure 18B Logic "0" Input Voltage (IR2127)
Logic "1" Input Voltage (IR2128)
vs Voltage

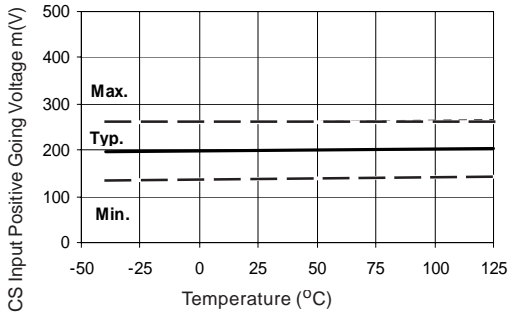

Figure 19A CS Input Positive Going Voltage
vs Temperature (IR2127/IR2128)

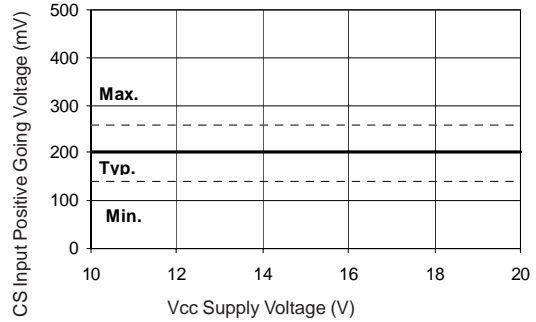

Figure 19B CS Input Positive Going Voltage
vs Voltage (IR2127/IR2128)

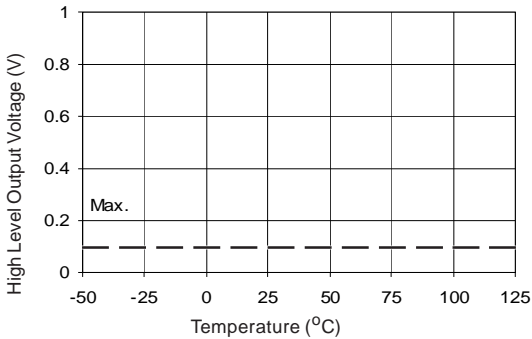

Figure 20A High Level Output vs Temperature

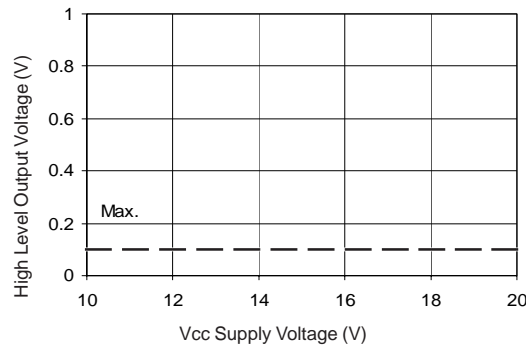

Figure 20B High Level Output vs Voltage

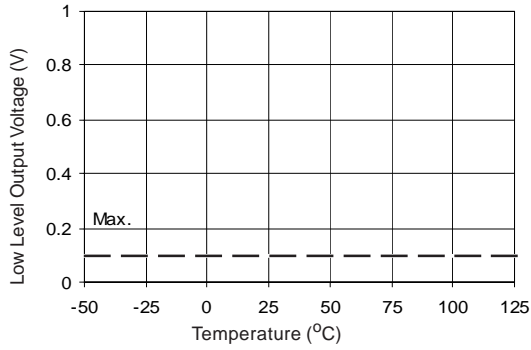

Figure 21A Low Level Output vs Temperature



Figure 21B Low Level Output vs Voltage

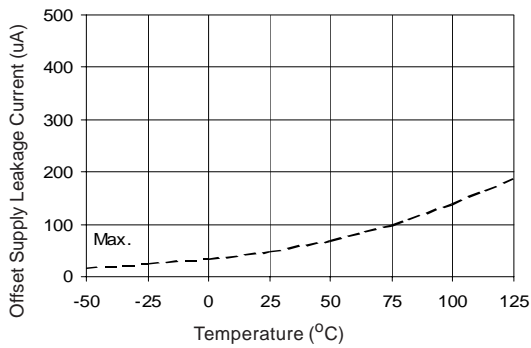

Figure 22A Offset Supply Current vs Temperature

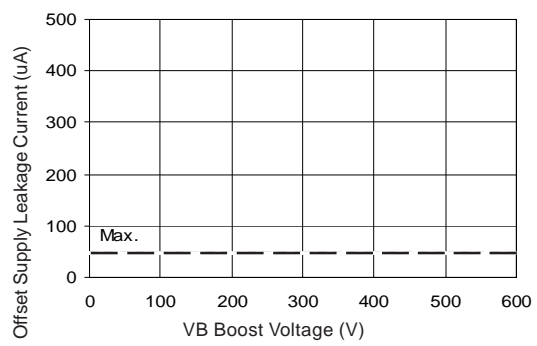

Figure 22B Offset Supply Current vs Voltage

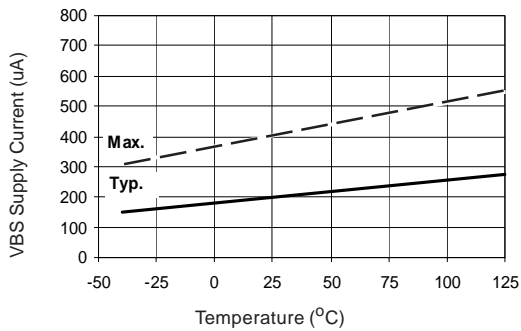

Figure 23A VBS Supply Current vs Temperature

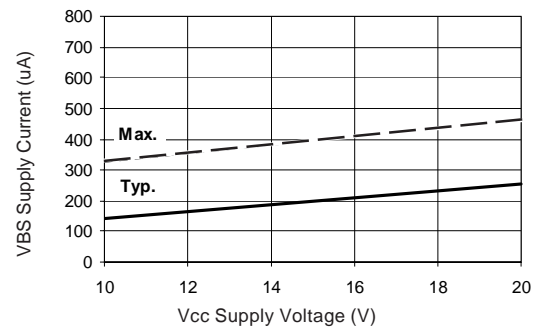

Figure 23B VBS Supply Current vs Voltage

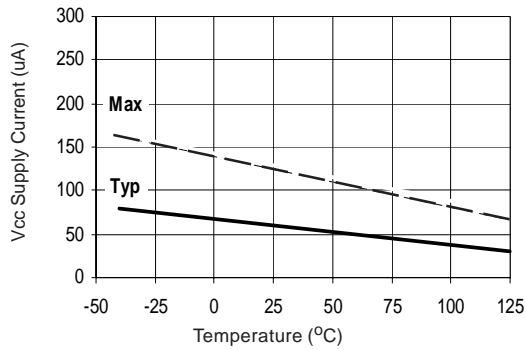

Figure 24A Vcc Supply Current vs Temperature

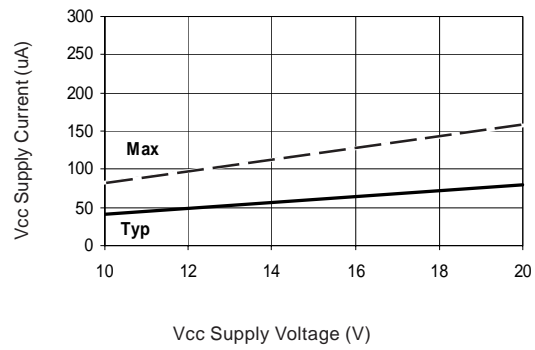

Figure 24B Vcc Supply Current vs Voltage

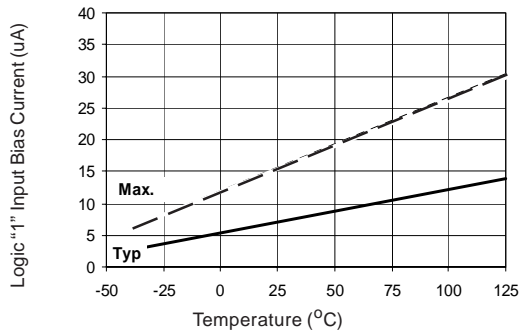

Figure 25A Logic "1" Input Current vs Temperature

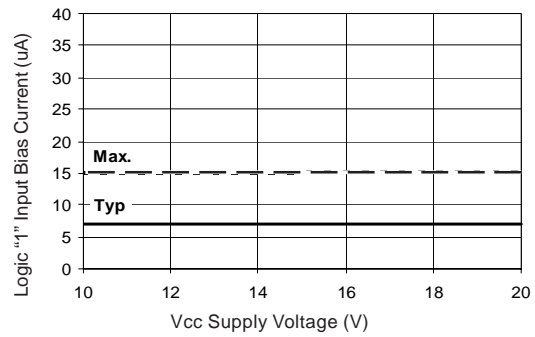

Figure 25B Logic "1" Input Current vs Voltage

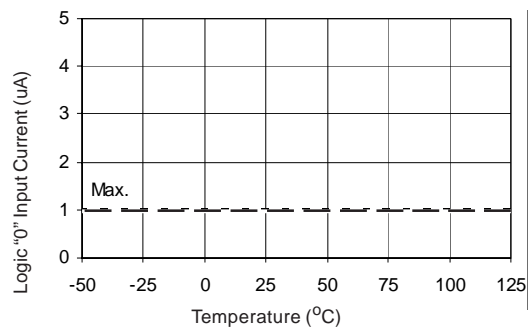

Figure 26A Logic "0" Input Current vs Temperature

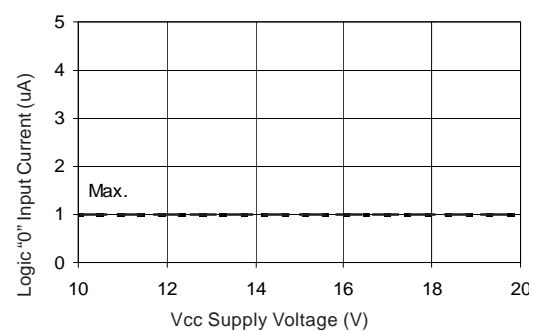

Figure 26B Logic "0" Input Current vs Voltage

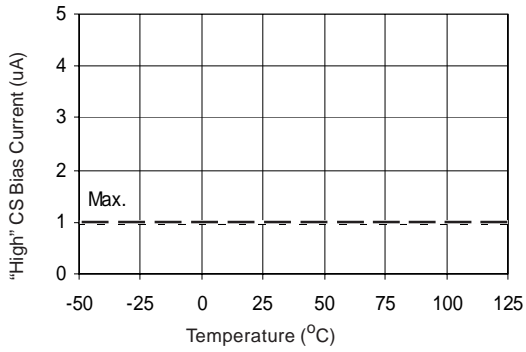

Figure 27A "High" CS Bias Current vs Temperature



Figure 27B "High" CS Bias Current vs Voltage

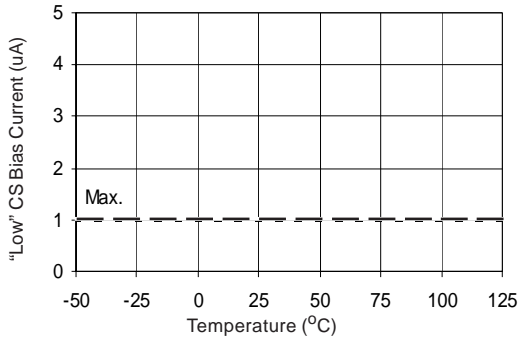

Figure 28A "Low" CS Bias Current vs Temperature

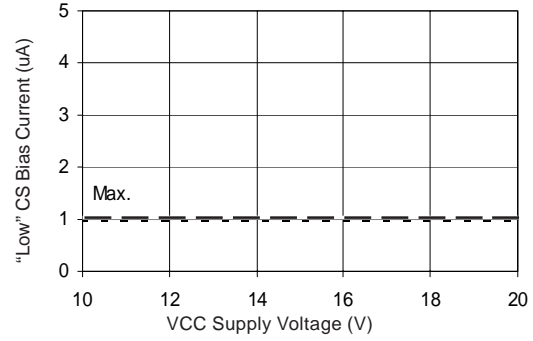

Figure 28B "Low" CS Bias Current vs Voltage

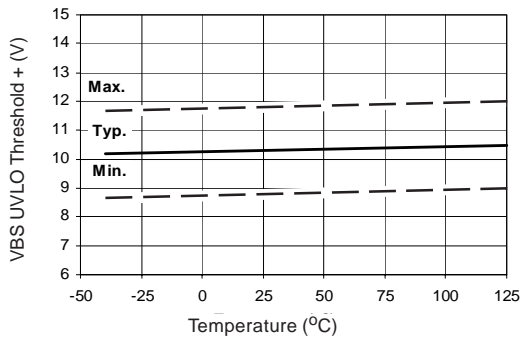

Figure 29A VBS Undervoltage Threshold (+) vs Temperature (IR2127/IR2128)

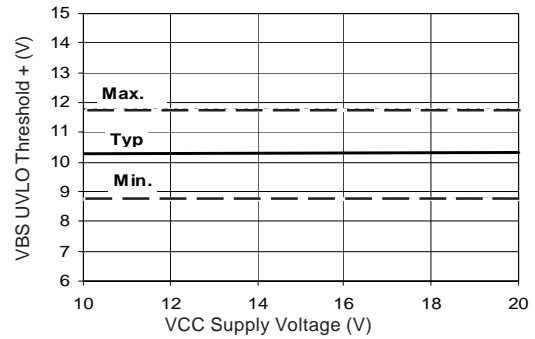

Figure 29B VBS Undervoltage Threshold (+) vs Voltage (IR2127/IR2128)

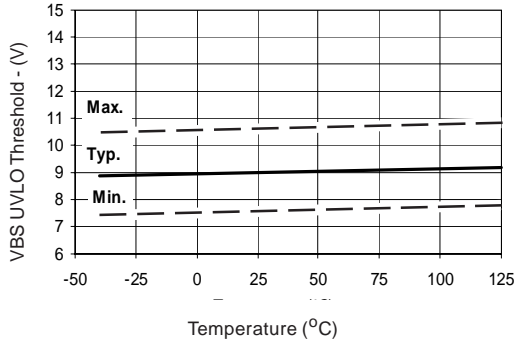

Figure 30A VBS Undervoltage Threshold (-) vs Temperature (IR2127/IR2128)

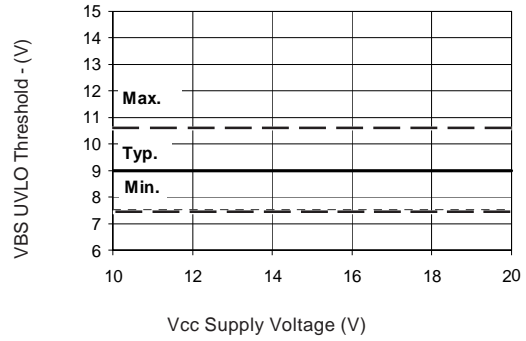

Figure 30B VBS Undervoltage Threshold (-) vs Voltage (IR2127/IR2128)

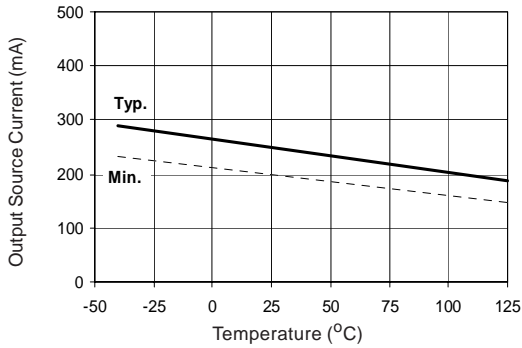

Figure 31A Output Source Current vs Temperature

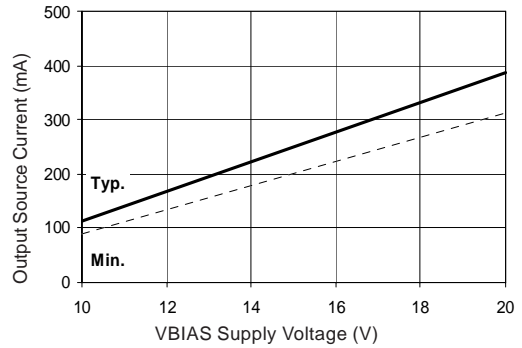

Figure 31B Output Source Current vs Voltage

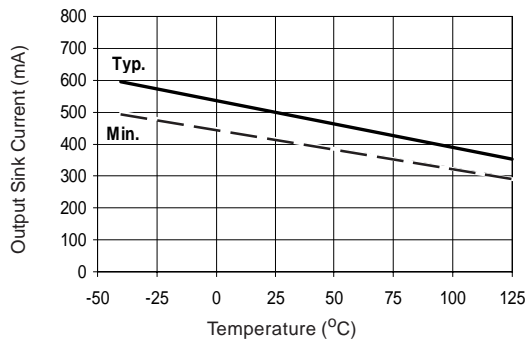

Figure 32A Output Sink Current vs Temperature

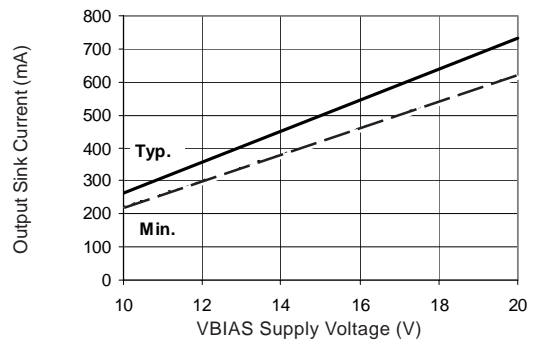
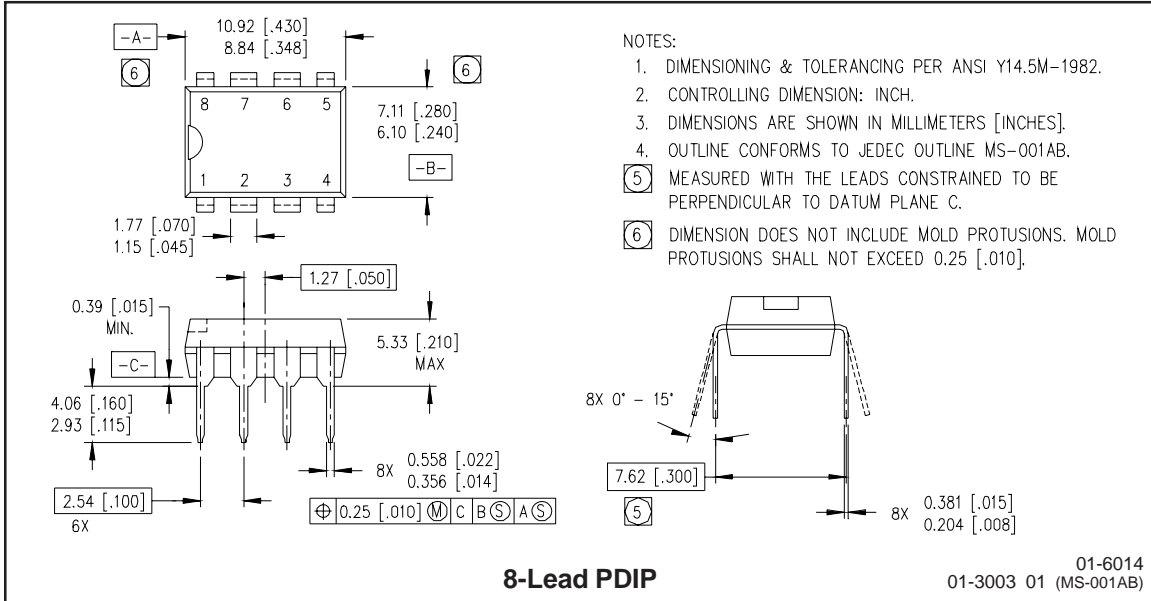
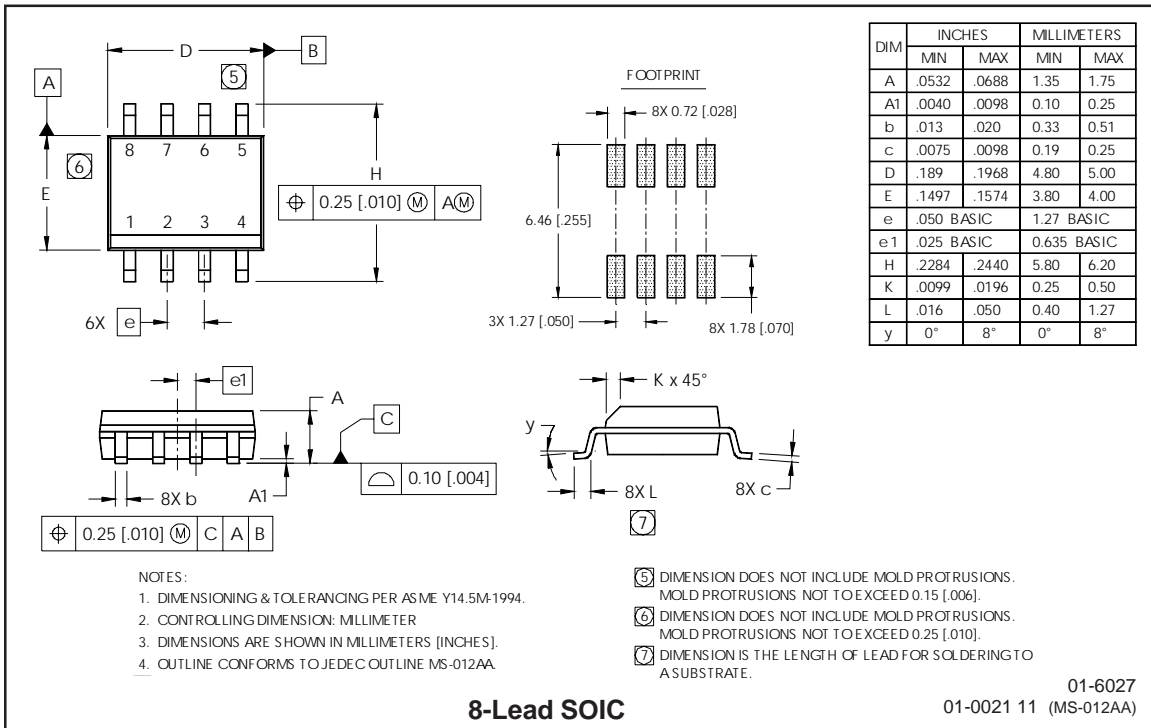

Figure 32B Output Sink Current vs Voltage

Case outlines



8-Lead PDIP



8-Lead SOIC

IR2127(S) / IR21271(S) / IR2128(S) & (PbF)



LEADFREE PART MARKING INFORMATION

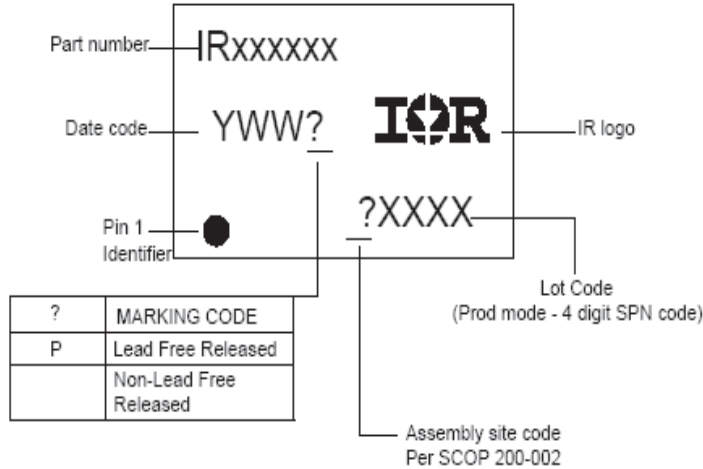

ORDER INFORMATION

Basic Part (Non-Lead Free)

8-Lead PDIP IR2127 order IR2127
 8-Lead SOIC IR2127S order IR2127S
 8-Lead PDIP IR21271 order IR21271
 8-Lead SOIC IR21271S order IR21271S
 8-Lead PDIP IR2128 order IR2128
 8-Lead SOIC IR2128S order IR2128S

Lead-Free Part

8-Lead PDIP IR2127 order IR2127PbF
 8-Lead SOIC IR2127S order IR2127SPbF
 8-Lead PDIP IR21271 order IR21271PbF
 8-Lead SOIC IR21271S order IR21271SPbF
 8-Lead PDIP IR2128 order IR2128PbF
 8-Lead SOIC IR2128S order IR2128SPbF



This product has been designed and qualified for the Industrial market. Qualification Standards can be found on IR's Web site. Data and specifications subject to change without notice.

IR WORLD HEADQUARTERS: 233 Kansas St., El Segundo, California 90245, USA Tel: (310) 252-7105

TAC Fax: (310) 252-7903

Visit us at www.irf.com for sales contact information.

09/08/04