

## Push-pull four channel driver with diodes

### Features

- 600 mA output current capability per channel
- 1.2 A peak output current (non repetitive) per channel
- Enable facility
- Overtemperature protection
- Logical "0" input voltage up to 1.5 V (high noise immunity)
- Internal clamp diodes

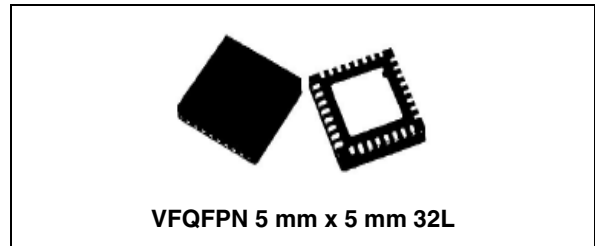

To simplify use as two bridges each pair of channels is equipped with an enable input. A separate supply input is provided for the logic, allowing operation at a lower voltage and internal clamp diodes are included.

This device is suitable for use in switching applications at frequencies up to 50 kHz.

The L2293Q is assembled in a VFQFPN-32L 5x5 package which has exposed pad available for heatsinking.

### Description

The device is a monolithic integrated high voltage, high current four channel driver designed to accept standard DTL or TTL logic levels and drive inductive loads (such as relays solenoids, DC and stepping motors) and switching power transistors.

**Figure 1. Block diagram**

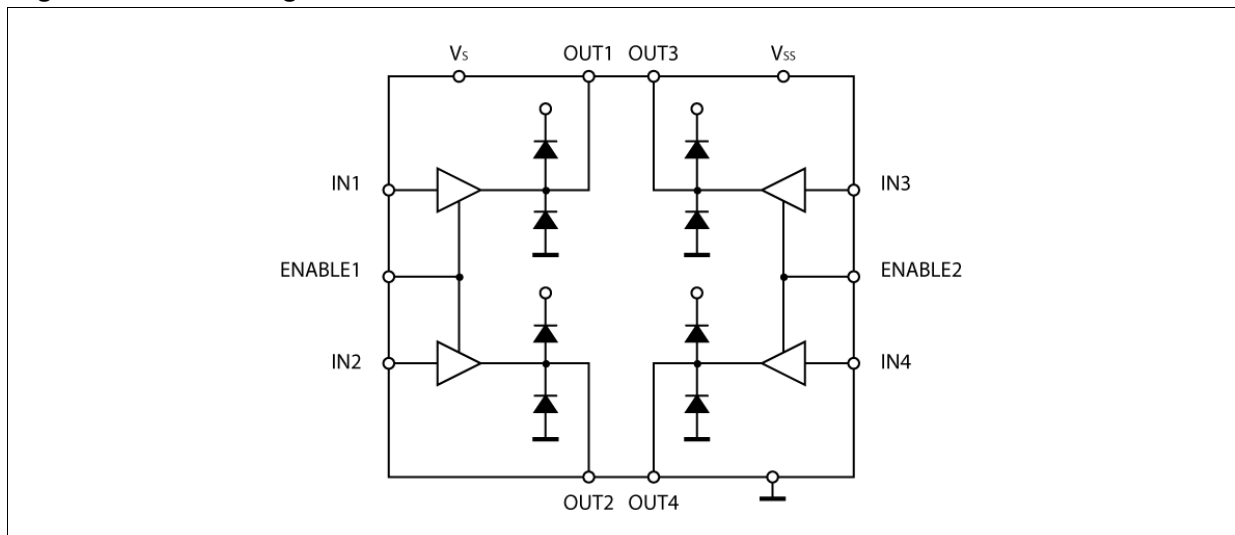

# Contents

<b>1</b>	<b>Electrical data</b> .....	<b>3</b>
1.1	Absolute maximum ratings .....	3
1.2	Recommended conditions .....	3
1.3	Thermal data .....	4
<b>2</b>	<b>Pin connection</b> .....	<b>5</b>
<b>3</b>	<b>Electrical characteristics</b> .....	<b>7</b>
<b>4</b>	<b>Package mechanical data</b> .....	<b>9</b>
<b>5</b>	<b>Order codes</b> .....	<b>11</b>
<b>6</b>	<b>Revision history</b> .....	<b>12</b>

# 1 Electrical data

## 1.1 Absolute maximum ratings

Table 1. Absolute maximum ratings

Symbol	Parameter	Value	Unit
$V_S$	Supply voltage	36	V
$V_{SS}$	Logic supply voltage	36	V
$V_i$	Input voltage	7	V
$V_{en}$	Enable voltage	7	V
$I_o$	Peak output current (100 $\mu$ s non repetitive)	1.2	A
$P_{tot}$	Total power dissipation at $T_{pins} = 90\text{ }^\circ\text{C}$	4	W
$T_J$	Junction temperature	150	$^\circ\text{C}$
$T_{STG}$	Storage temperature	- 40 to 150	$^\circ\text{C}$

## 1.2 Recommended conditions

Table 2. Recommended conditions

Symbol	Parameter	Value			Unit
		Min	Typ	Max	
$V_S$	Supply voltage	$V_{SS}$		36	V
$V_{SS}$	Logic supply voltage	2.8 <sup>(1)</sup>		36	V
$T_J$	Junction temperature	-20 <sup>(1)</sup>		125	$^\circ\text{C}$

1. See [Figure 2](#)

### 1.3 Thermal data

Figure 2. Typical minimum logic supply voltage vs junction temperature

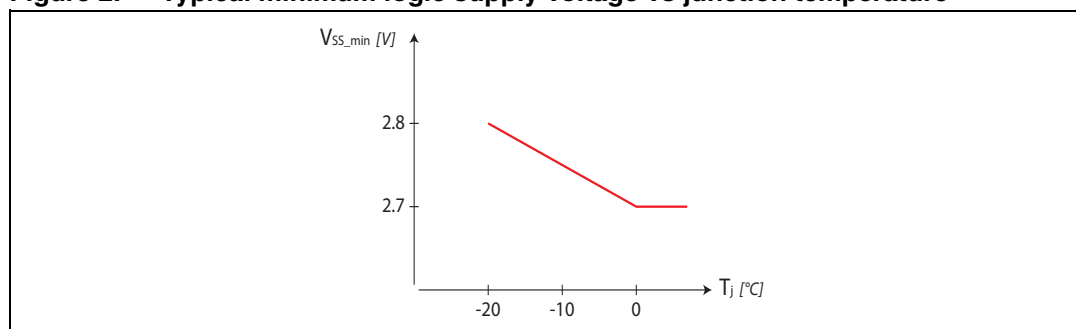

Table 3. Thermal data

Symbol	Parameter	Value	Unit
R <sub>th(JA)</sub>	Thermal resistance junction-ambient max. <sup>(1)</sup>	42	°C/W

1. Mounted on a double-layer FR4 PCB with a dissipating copper surface of 0.5 cm<sup>2</sup> on the top side plus 6 cm<sup>2</sup> ground layer connected through 18 via holes (9 below the IC).

## 2 Pin connection

Figure 2. Pin connection (top view)

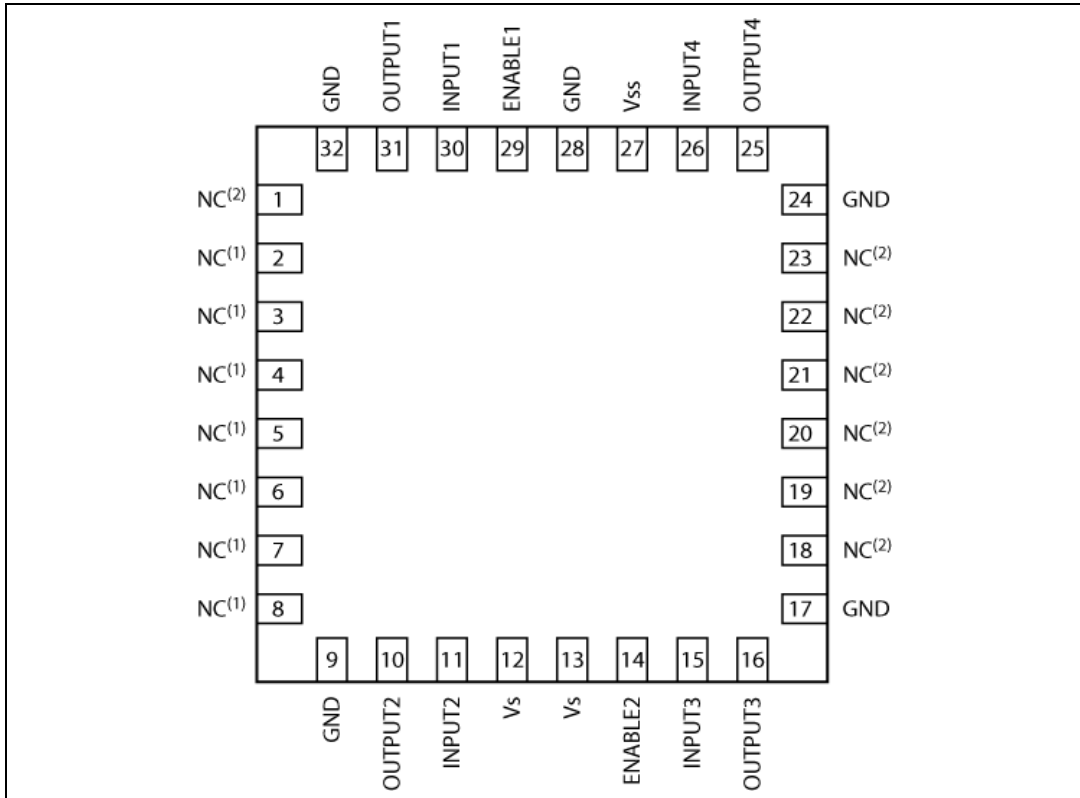

Note:   
 NC<sup>(1)</sup> These NC pins are connected to the exposed PAD.   
 The exposed PAD must be connected to GND pins.   
 NC<sup>(2)</sup> These NC pins can be connected to GND pins and exposed PAD.

Figure 3. Recommended PCB layout for R<sub>th(JA)</sub> optimization

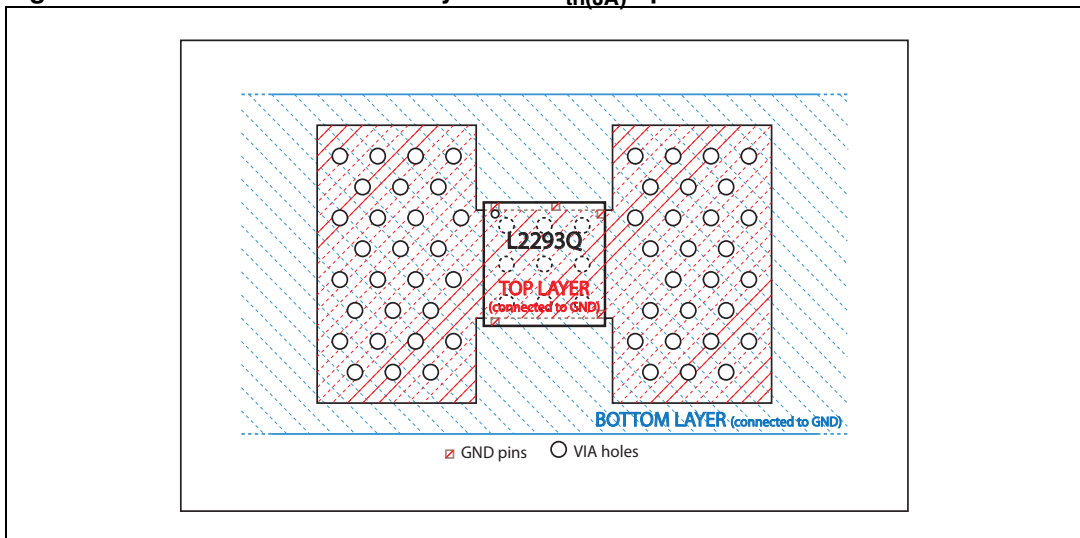

**Table 4. Pin description**

Pin n°	Name	Type	Function
1, 18, 19, 20, 21, 22, 23	NC		Not connected
2, 3, 4, 5, 6, 7,	NC		Pins connected to the exposed PAD
8, 9, 17, 24, 28, 32	GND		Ground
10	OUTPUT2	O	Output 2
11	INPUT2	I	Input 2
12, 13	V <sub>S</sub>		Supply voltage for the power output stages. A non-inductive 100 nF capacitor must be connected between these pins and ground.
14	ENABLE2	I	Enable 2 input, the LOW state disables the Output 3 and Output 4.
15	INPUT3	I	Input 3
16	OUTPUT3	O	Output 3
25	OUTPUT4	O	Output 4
26	INPUT4	I	Input 4
27	V <sub>SS</sub>		Supply voltage for the logic blocks. A 100 nF capacitor must be connected between this pin and ground.
29	ENABLE1	I	Enable 1 input, the LOW state disables the output 1 and Output 2.
30	INPUT1	I	Input 1
31	OUTPUT1	O	Output 1

### 3 Electrical characteristics

For each channel,  $V_S = 24\text{ V}$ ,  $V_{SS} = 5\text{ V}$ ,  $T_A = 25\text{ °C}$ , unless otherwise specified.

**Table 5. Electrical characteristics**

Symbol	Pin	Parameter	Test condition	Min	Typ	Max	Unit
$I_S$	12, 13	Total quiescent supply current	$V_i = L; I_O = 0; V_{en} = H$		2	6	mA
			$V_i = H; I_O = 0; V_{en} = H$		16	24	mA
			$V_{en} = L$			4	mA
$I_{SS}$	27	Total quiescent logic supply current	$V_i = L; I_O = 0; V_{en} = H$		44	60	mA
			$V_i = H; I_O = 0; V_{en} = H$		16	22	mA
			$V_{en} = L$		16	24	mA
$V_{IL}$	11, 15, 26, 30	Input low voltage		-0.3		1.5	V
$V_{IH}$	11, 15, 26, 30	Input high voltage	$V_{SS} \leq 7\text{ V}$	2.3		$V_{SS}$	V
			$V_{SS} > 7\text{ V}$	2.3		7	V
$I_{IL}$	11, 15, 26, 30	Low voltage input current	$V_{IL} = 1.5\text{ V}$			-10	$\mu\text{A}$
$I_{IH}$	11, 15, 26, 30	High voltage input current	$2.3\text{ V} \leq V_{IH} \leq V_{SS} - 0.6\text{ V}$		30	100	$\mu\text{A}$
$V_{enL}$	14, 29	Enable low voltage		-0.3		1.5	V
$V_{enH}$	14, 29	Enable high voltage	$V_{SS} \leq 7\text{ V}$	2.3		$V_{SS}$	V
			$V_{SS} > 7\text{ V}$	2.3		7	V
$I_{enL}$	14, 29	Low voltage enable current	$V_{enL} = 1.5\text{ V}$		-30	-100	$\mu\text{A}$
$I_{enH}$	14, 29	High voltage enable current	$2.3\text{ V} \leq V_{enH} \leq V_{SS} - 0.6\text{ V}$			$\pm 10$	$\mu\text{A}$
$V_{CE(sat)H}$	10, 16, 25, 31	Source output saturation voltage	$I_O = -0.6\text{ A}$		1.4	1.8	V
$V_{CE(sat)L}$	10, 16, 25, 31	Sink output saturation voltage	$I_O = +0.6\text{ A}$		1.2	1.8	V
$V_F$		Clamp diode forward voltage	$I_O = 600\text{ nA}$		1.3		V

$V_S = 24\text{ V}$ ,  $V_{SS} = 5\text{ V}$ ,  $T_A = 25\text{ }^\circ\text{C}$ , unless otherwise specified.

**Table 6. AC operation**

Symbol	Parameter	Test condition	Min	Typ	Max	Unit
$t_r$	Rise time <sup>(1)</sup>	0.1 to 0.9 $V_O$		250		ns
$t_f$	Fall time <sup>(1)</sup>	0.9 to 0.1 $V_O$		250		ns
$t_{on}$	Turn-on delay <sup>(1)</sup>	0.5 $V_i$ to 0.5 $V_O$		750		ns
$t_{off}$	Turn-off delay <sup>(1)</sup>	0.5 $V_i$ to 0.5 $V_O$		200		ns

1. See [Figure 4](#)

**Figure 4. Switching times**

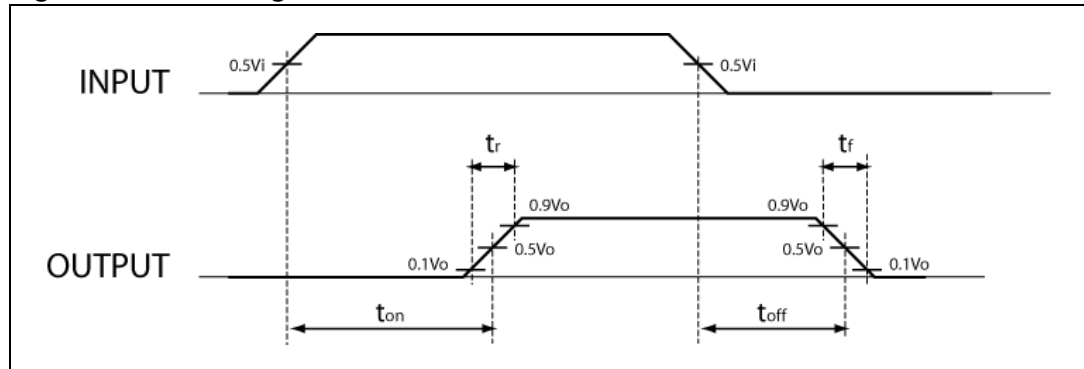

**Table 7. Truth table (one channel)**

Input	Enable <sup>(1)</sup>	Output
H	H	H
L	H	L
H	L	Z <sup>(2)</sup>
L	L	Z <sup>(2)</sup>

1. Relative to the considered channel
2. Z = High output impedance



## 4 Package mechanical data

In order to meet environmental requirements, ST offers these devices in different grades of ECOPACK® packages, depending on their level of environmental compliance. ECOPACK® specifications, grade definitions and product status are available at: [www.st.com](http://www.st.com). ECOPACK is an ST trademark.

**Table 8. VFQFPN 5x5x1.0 32L pitch 0.50**

Dim.	Databook (mm)		
	Min	Typ	Max
A	0.80	0.85	0.95
b	0.18	0.25	0.30
b1	0.165	0.175	0.185
D	4.85	5.00	5.15
D2	3.00	3.10	3.20
D3	1.10	1.20	1.30
E	4.85	5.00	5.15
E2	4.20	4.30	4.40
E3	0.60	0.70	0.80
e		0.50	
L	0.30	0.40	0.50
ddd			0.08

- Note:*
- 1 VFQFPN stands for thermally enhanced very thin profile fine pitch quad flat package no lead. Very thin profile:  $0.80 < A \leq 1.00$  mm.
  - 2 Details of terminal 1 are optional but must be located on the top surface of the package by using either a mold or marked features.

Figure 5. Package dimensions

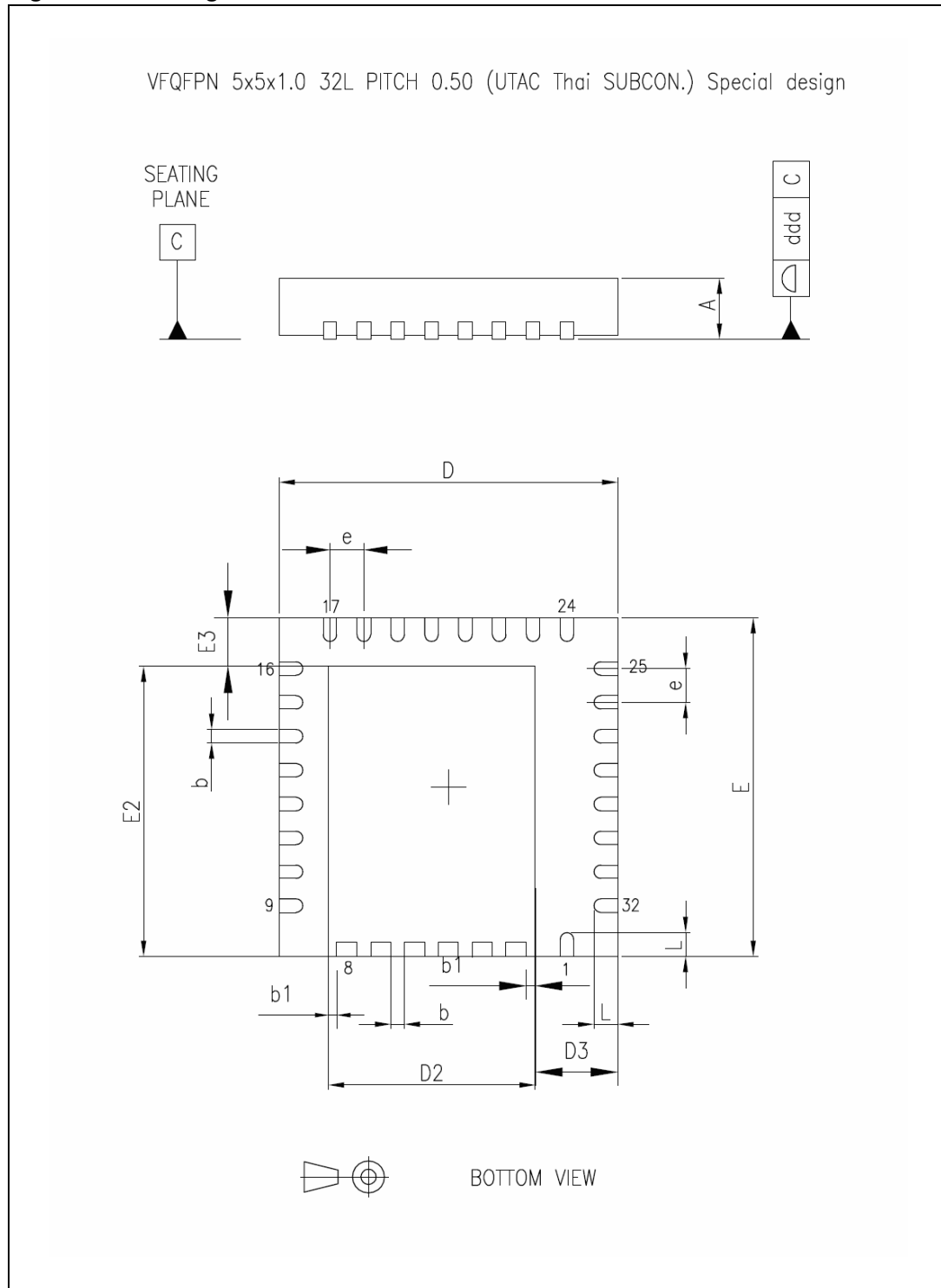

## 5 Order codes

**Table 9. Order code**

<b>Order code</b>	<b>Package</b>	<b>Packaging</b>
L2293Q	VFQFPN 5x5x1.0 32L	Tube

## 6 Revision history

**Table 10. Document revision history**

Date	Revision	Changes
10-Jul-2008	1	First release
26-Feb-2009	2	Updated <a href="#">Table 3 on page 4</a>
12-Aug-2009	3	Updated description in coverpage

**Please Read Carefully:**

Information in this document is provided solely in connection with ST products. STMicroelectronics NV and its subsidiaries ("ST") reserve the right to make changes, corrections, modifications or improvements, to this document, and the products and services described herein at any time, without notice.

All ST products are sold pursuant to ST's terms and conditions of sale.

Purchasers are solely responsible for the choice, selection and use of the ST products and services described herein, and ST assumes no liability whatsoever relating to the choice, selection or use of the ST products and services described herein.

No license, express or implied, by estoppel or otherwise, to any intellectual property rights is granted under this document. If any part of this document refers to any third party products or services it shall not be deemed a license grant by ST for the use of such third party products or services, or any intellectual property contained therein or considered as a warranty covering the use in any manner whatsoever of such third party products or services or any intellectual property contained therein.

**UNLESS OTHERWISE SET FORTH IN ST'S TERMS AND CONDITIONS OF SALE ST DISCLAIMS ANY EXPRESS OR IMPLIED WARRANTY WITH RESPECT TO THE USE AND/OR SALE OF ST PRODUCTS INCLUDING WITHOUT LIMITATION IMPLIED WARRANTIES OF MERCHANTABILITY, FITNESS FOR A PARTICULAR PURPOSE (AND THEIR EQUIVALENTS UNDER THE LAWS OF ANY JURISDICTION), OR INFRINGEMENT OF ANY PATENT, COPYRIGHT OR OTHER INTELLECTUAL PROPERTY RIGHT.**

**UNLESS EXPRESSLY APPROVED IN WRITING BY AN AUTHORIZED ST REPRESENTATIVE, ST PRODUCTS ARE NOT RECOMMENDED, AUTHORIZED OR WARRANTED FOR USE IN MILITARY, AIR CRAFT, SPACE, LIFE SAVING, OR LIFE SUSTAINING APPLICATIONS, NOR IN PRODUCTS OR SYSTEMS WHERE FAILURE OR MALFUNCTION MAY RESULT IN PERSONAL INJURY, DEATH, OR SEVERE PROPERTY OR ENVIRONMENTAL DAMAGE. ST PRODUCTS WHICH ARE NOT SPECIFIED AS "AUTOMOTIVE GRADE" MAY ONLY BE USED IN AUTOMOTIVE APPLICATIONS AT USER'S OWN RISK.**

Resale of ST products with provisions different from the statements and/or technical features set forth in this document shall immediately void any warranty granted by ST for the ST product or service described herein and shall not create or extend in any manner whatsoever, any liability of ST.

ST and the ST logo are trademarks or registered trademarks of ST in various countries.

Information in this document supersedes and replaces all information previously supplied.

The ST logo is a registered trademark of STMicroelectronics. All other names are the property of their respective owners.

© 2009 STMicroelectronics - All rights reserved

STMicroelectronics group of companies

Australia - Belgium - Brazil - Canada - China - Czech Republic - Finland - France - Germany - Hong Kong - India - Israel - Italy - Japan - Malaysia - Malta - Morocco - Philippines - Singapore - Spain - Sweden - Switzerland - United Kingdom - United States of America

[www.st.com](http://www.st.com)