

## Microcontroller Supervisory Circuit with Open Drain Output

### FEATURES

- Holds microcontroller in reset until supply voltage reaches stable operating level
- Resets microcontroller during power loss
- Precision monitoring of 3V, 3.3V and 5V systems
- 7 voltage trip points available
- Active low  $\overline{\text{RESET}}$  pin
- Open drain output
- Internal pull-up resistor (5 k $\Omega$ ) for MCP130
- Holds  $\overline{\text{RESET}}$  for 350 ms (typical)
- $\overline{\text{RESET}}$  to  $V_{CC} = 1.0V$
- Accuracy of  $\pm 125$  mV for 5V systems and  $\pm 75$  mV for 3V systems over temperature
- 45  $\mu A$  typical operating current
- Temperature range:
  - Industrial (I): -40°C to +85°C

### DESCRIPTION

The Microchip Technology Inc. MCP120/130 is a voltage supervisory device designed to keep a microcontroller in reset until the system voltage has reached the proper level and stabilized. It also operates as protection from brown-out conditions when the supply voltage drops below a safe operating level. Both devices are available with a choice of seven different trip voltages and both have open drain outputs. The MCP130 has an internal 5 k $\Omega$  pullup resistor. Both devices have active low  $\overline{\text{RESET}}$  pins. The MCP120/130 will assert the  $\overline{\text{RESET}}$  signal whenever the voltage on the VDD pin is below the trip-point voltage.

### PACKAGES



### BLOCK DIAGRAM



## 1.0 ELECTRICAL CHARACTERISTICS

### 1.1 Maximum Ratings\*

V<sub>DD</sub>..... 7.0V  
 All inputs and outputs w.r.t. V<sub>SS</sub> ..... -0.6V to V<sub>DD</sub> +1.0V  
 Storage temperature ..... -65°C to +150°C  
 Ambient temp. with power applied ..... -65°C to +125°C  
 ESD protection on all pins ..... ≥ 2 kV

**\*Notice:** Stresses above those listed under “Maximum Ratings” may cause permanent damage to the device. This is a stress rating only and functional operation of the device at those or any other conditions above those indicated in the operational listings of this specification is not implied. Exposure to maximum rating conditions for extended periods may affect device reliability.

## DC AND AC CHARACTERISTICS

All parameters apply at the specified temp and voltage ranges unless otherwise noted.		V <sub>DD</sub> = 1.0 - 5.5V Industrial (I): -40°C to +85°C					
Parameter	Symbol	Min.	Typ.	Max.	Units	Test Conditions	
Operating Voltage Range	V <sub>DD</sub>	1.0	—	5.5	V		
V <sub>DD</sub> Value to RESET	V <sub>DD</sub> <sub>MIN</sub>	1.0	—	—	V		
Operating Current	I <sub>DD</sub>	—	45	60	μA	V <sub>DD</sub> = 5.5V (no load)	
V <sub>DD</sub> Trip Point	MCP1X0-270 MCP1X0-300 MCP1X0-315 MCP1X0-450 MCP1X0-460 MCP1X0-475 MCP1X0-485	V <sub>TRIP</sub>	2.55 2.85 3.0 4.25 4.35 4.50 4.60	2.625 2.925 3.075 4.375 4.475 4.625 4.725	2.7 3.0 3.15 4.50 4.60 4.75 4.85	V	
RESET Low Level Output Voltage	MCP1X0-270 MCP1X0-300 MCP1X0-315	V <sub>OL</sub>	—	—	0.4	V	I <sub>OL</sub> = 3.2 mA, V <sub>DD</sub> = V <sub>TRIP</sub> <sub>MIN</sub>
	MCP1X0-450 MCP1X0-460 MCP1X0-475 MCP1X0-485		—	—	0.6		I <sub>OL</sub> = 8.5 mA, V <sub>DD</sub> = V <sub>TRIP</sub> <sub>MIN</sub>
RESET High Level Output Voltage (MCP130 Only)	MCP130-xxx (All V <sub>TRIP</sub> Points)	V <sub>OH</sub>	V <sub>DD</sub> -0.7	—	—	V	I <sub>OH</sub> = 50 μA, V <sub>DD</sub> > V <sub>TRIP</sub> <sub>MAX</sub>
Pull-up Resistor (MCP130 Only)			—	5	—	kΩ	
Output Leakage (MCP120 Only)			—	1	—	μA	
Threshold Hysteresis	V <sub>HYS</sub>	—	50	—	—	mV	
V <sub>DD</sub> Detect to RESET Inactive	t <sub>RPU</sub>	150	350	700	—	ms	
V <sub>DD</sub> Detect to RESET	t <sub>RPD</sub>	—	10	—	—	μs	V <sub>DD</sub> ramped from V <sub>TRIP</sub> <sub>MAX</sub> + 250 mV down to V <sub>TRIP</sub> <sub>MIN</sub> - 250 mV
<b>Note:</b> Typical values are for 25°C and V <sub>DD</sub> = 5.0V							



Figure 1-1: MCP120/130 Timing Diagram

# MCP120/130

## 2.0 APPLICATIONS INFORMATION

### 2.1 The Need for Supervisory Circuits

For many of today's microcontroller applications, care must be taken to prevent low power conditions that can cause many different system problems. The most common causes are brown-out conditions where the system supply drops below the operating level momentarily, and the second, is when a slowly decaying power supply causes the microcontroller to begin executing instructions without enough voltage to sustain SRAM and producing indeterminate results.



Figure 2-1: Typical Application

### 2.2 Negative Going V<sub>DD</sub> Transients

Many system designers implementing POR circuits are concerned about the minimum pulse width required to cause a reset. Figure 2-2 shows typical transient voltage below the trip point ( $V_{TRIP} - V_{DD}$ ) vs. transient duration. It shows that the farther below the trip point the transient pulse goes, the duration of the pulse required to cause a reset gets shorter. A 0.1  $\mu\text{F}$  bypass cap mounted as close as possible to the V<sub>DD</sub> pin provides additional transient immunity.



Figure 2-2: Typical Transient Response

## 2.3 Effect of Temperature on Timeout Period (trPU)

The timeout period (trPU) determines how long the device remains in the reset condition. This is controlled by an internal RC timer and is effected by both VDD and temperature. The graph shown in Figure 2-3 shows typical response for different VDD values and temperatures.



**Figure 2-3:** trPU vs. Temperature



**Figure 2-4:** IDD vs. Temperature



**Figure 2-5:** Normalized VTRIP vs. Temperature



**Figure 2-6:** VOL vs. IOL



**Figure 2-7:** Normalized IOL vs. Temperature

# MCP120/130

## 3.0 PACKAGING INFORMATION

### 3.1 Package Marking Information

3-Lead Plastic Transistor Outline (TO-92)

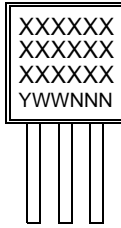

Example:

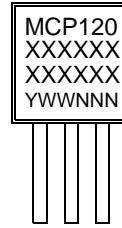

8-Lead Plastic Small Outline (SOIC)

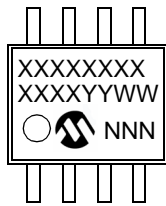

Example:

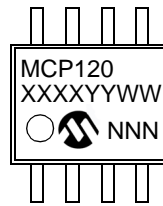

3-Lead Plastic Small Outline Transistor (SOT23)

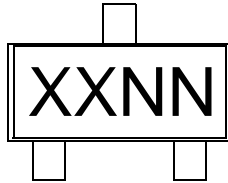

Example:

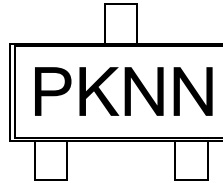

#### SOT23 PARTS LABELING:

The table below identifies the first 2 characters (XX) in the 4-character field (XXNN) for marking of the 3-Lead SOT23 package.

Mark	Part Number	Mark	Part Number
SJ	MCP120T-270I/TT	PJ	MCP130T-270I/TT
SK	MCP120T-300I/TT	PK	MCP130T-300I/TT
SL	MCP120T-315I/TT	PL	MCP130T-315I/TT
SM	MCP120T-450I/TT	PM	MCP130T-450I/TT
SN	MCP120T-460I/TT	PN	MCP130T-460I/TT
SO	MCP120T-475I/TT	PO	MCP130T-475I/TT
SP	MCP120T-485I/TT	PP	MCP130T-485I/TT

<b>Legend:</b>	XX...X	Customer specific information*
	YY	Year code (last 2 digits of calendar year)
	WW	Week code (week of January 1 is week '01')
	NNN	Alphanumeric traceability code
<b>Note:</b>	In the event the full Microchip part number cannot be marked on one line, it will be carried over to the next line thus limiting the number of available characters for customer specific information.	

\* Standard OTP marking consists of Microchip part number, year code, week code, and traceability code. For OTP marking beyond this, certain price adders apply. Please check with your Microchip Sales Office. For QTP devices, any special marking adders are included in QTP price.

## 3.2 Package Detail Information

### 3-Lead Plastic Transistor Outline (TO) (TO-92)



Units		INCHES*			MILLIMETERS		
Dimension Limits		MIN	NOM	MAX	MIN	NOM	MAX
Number of Pins	n		3			3	
Pitch	p		.050			1.27	
Bottom to Package Flat	A	.130	.143	.155	3.30	3.62	3.94
Overall Width	E1	.175	.186	.195	4.45	4.71	4.95
Overall Length	D	.170	.183	.195	4.32	4.64	4.95
Molded Package Radius	R	.085	.090	.095	2.16	2.29	2.41
Tip to Seating Plane	L	.500	.555	.610	12.70	14.10	15.49
Lead Thickness	c	.014	.017	.020	0.36	0.43	0.51
Lead Width	B	.016	.019	.022	0.41	0.48	0.56
Mold Draft Angle Top	α	4	5	6	4	5	6
Mold Draft Angle Bottom	β	2	3	4	2	3	4

\*Controlling Parameter

**Notes:**

Dimensions D and E1 do not include mold flash or protrusions. Mold flash or protrusions shall not exceed .010" (0.254mm) per side.  
 JEDEC Equivalent: TO-92  
 Drawing No. C04-101

# MCP120/130

## 3-Lead Plastic Small Outline Transistor (TT) (SOT23)

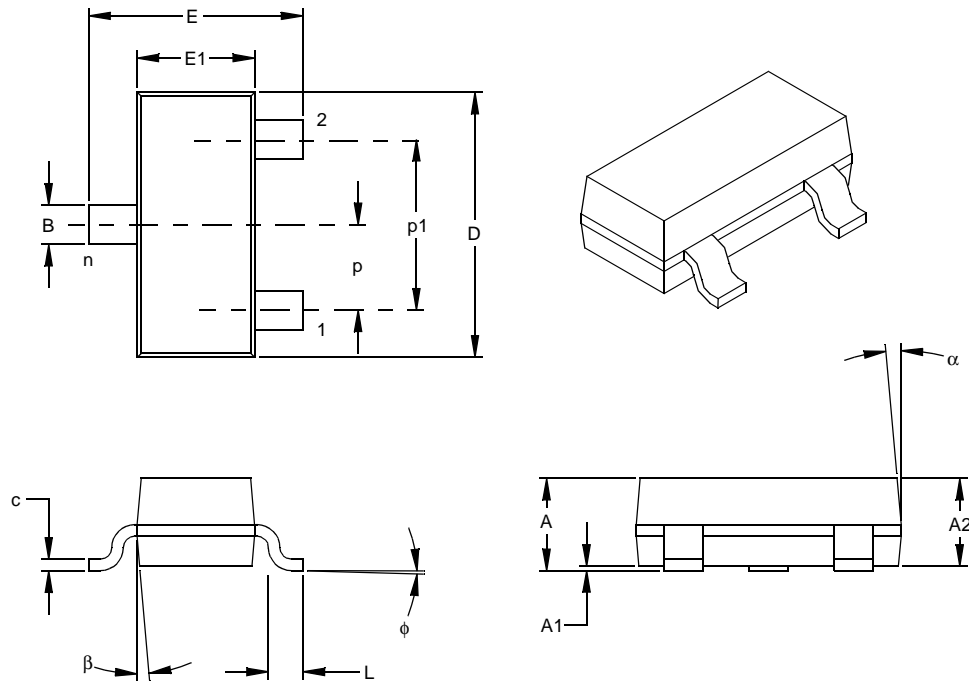

Units		INCHES*			MILLIMETERS		
Dimension Limits		MIN	NOM	MAX	MIN	NOM	MAX
Number of Pins	n		3			3	
Pitch	p		.038			0.96	
Outside lead pitch (basic)	p1		.076			1.92	
Overall Height	A	.035	.040	.044	0.89	1.01	1.12
Molded Package Thickness	A2	.035	.037	.040	0.88	0.95	1.02
Standoff §	A1	.000	.002	.004	0.01	0.06	0.10
Overall Width	E	.083	.093	.104	2.10	2.37	2.64
Molded Package Width	E1	.047	.051	.055	1.20	1.30	1.40
Overall Length	D	.110	.115	.120	2.80	2.92	3.04
Foot Length	L	.014	.018	.022	0.35	0.45	0.55
Foot Angle	φ	0	5	10	0	5	10
Lead Thickness	c	.004	.006	.007	0.09	0.14	0.18
Lead Width	B	.015	.017	.020	0.37	0.44	0.51
Mold Draft Angle Top	α	0	5	10	0	5	10
Mold Draft Angle Bottom	β	0	5	10	0	5	10

\* Controlling Parameter

§ Significant Characteristic

### Notes:

Dimensions D and E1 do not include mold flash or protrusions. Mold flash or protrusions shall not exceed .010" (0.254mm) per side.

JEDEC Equivalent: TO-236

Drawing No. C04-104



## 8-Lead Plastic Small Outline (SN) – Narrow, 150 mil (SOIC)



Units		INCHES*			MILLIMETERS		
Dimension	Limits	MIN	NOM	MAX	MIN	NOM	MAX
Number of Pins	n		8			8	
Pitch	p		.050			1.27	
Overall Height	A	.053	.061	.069	1.35	1.55	1.75
Molded Package Thickness	A2	.052	.056	.061	1.32	1.42	1.55
Standoff §	A1	.004	.007	.010	0.10	0.18	0.25
Overall Width	E	.228	.237	.244	5.79	6.02	6.20
Molded Package Width	E1	.146	.154	.157	3.71	3.91	3.99
Overall Length	D	.189	.193	.197	4.80	4.90	5.00
Chamfer Distance	h	.010	.015	.020	0.25	0.38	0.51
Foot Length	L	.019	.025	.030	0.48	0.62	0.76
Foot Angle	φ	0	4	8	0	4	8
Lead Thickness	c	.008	.009	.010	0.20	0.23	0.25
Lead Width	B	.013	.017	.020	0.33	0.42	0.51
Mold Draft Angle Top	α	0	12	15	0	12	15
Mold Draft Angle Bottom	β	0	12	15	0	12	15

\* Controlling Parameter  
 § Significant Characteristic

**Notes:**

Dimensions D and E1 do not include mold flash or protrusions. Mold flash or protrusions shall not exceed .010" (0.254mm) per side.  
 JEDEC Equivalent: MS-012  
 Drawing No. C04-057

# MCP120/130

---

## ON-LINE SUPPORT

Microchip provides on-line support on the Microchip World Wide Web (WWW) site.

The web site is used by Microchip as a means to make files and information easily available to customers. To view the site, the user must have access to the Internet and a web browser, such as Netscape or Microsoft Explorer. Files are also available for FTP download from our FTP site.

### Connecting to the Microchip Internet Web Site

The Microchip web site is available by using your favorite Internet browser to attach to:

**[www.microchip.com](http://www.microchip.com)**

The file transfer site is available by using an FTP service to connect to:

**<ftp://ftp.microchip.com>**

The web site and file transfer site provide a variety of services. Users may download files for the latest Development Tools, Data Sheets, Application Notes, User's Guides, Articles and Sample Programs. A variety of Microchip specific business information is also available, including listings of Microchip sales offices, distributors and factory representatives. Other data available for consideration is:

- Latest Microchip Press Releases
- Technical Support Section with Frequently Asked Questions
- Design Tips
- Device Errata
- Job Postings
- Microchip Consultant Program Member Listing
- Links to other useful web sites related to Microchip Products
- Conferences for products, Development Systems, technical information and more
- Listing of seminars and events

## Systems Information and Upgrade Hot Line

The Systems Information and Upgrade Line provides system users a listing of the latest versions of all of Microchip's development systems software products. Plus, this line provides information on how customers can receive any currently available upgrade kits. The Hot Line Numbers are:

1-800-755-2345 for U.S. and most of Canada, and

1-480-792-7302 for the rest of the world.

## READER RESPONSE

It is our intention to provide you with the best documentation possible to ensure successful use of your Microchip product. If you wish to provide your comments on organization, clarity, subject matter, and ways in which our documentation can better serve you, please FAX your comments to the Technical Publications Manager at (480) 792-7578.

Please list the following information, and use this outline to provide us with your comments about this Data Sheet.

To: Technical Publications Manager Total Pages Sent  
RE: Reader Response  
From: Name \_\_\_\_\_  
Company \_\_\_\_\_  
Address \_\_\_\_\_  
City / State / ZIP / Country \_\_\_\_\_  
Telephone: (\_\_\_\_\_) \_\_\_\_\_ - \_\_\_\_\_ FAX: (\_\_\_\_\_) \_\_\_\_\_ - \_\_\_\_\_

Application (optional):

Would you like a reply? \_\_\_Y \_\_\_N

Device: **MCP120/130**

Literature Number: **DS11184D**

Questions:

1. What are the best features of this document?

---

---

2. How does this document meet your hardware and software development needs?

---

---

3. Do you find the organization of this data sheet easy to follow? If not, why?

---

---

4. What additions to the data sheet do you think would enhance the structure and subject?

---

---

5. What deletions from the data sheet could be made without affecting the overall usefulness?

---

---

6. Is there any incorrect or misleading information (what and where)?

---

---

7. How would you improve this document?

---

---

8. How would you improve our software, systems, and silicon products?

---

---

# MCP120/130

---

NOTES:

NOTES:

# MCP120/130

## PRODUCT IDENTIFICATION SYSTEM

To order or to obtain information (e.g., on pricing or delivery), please refer to the factory or the listed sales offices.

<u>PART NO.</u>	<u>X</u>	<u>X</u>	<u>X</u>	<u>XX</u>
Device	<u>RESET/</u> <u>RESET</u> VTRIP Voltage	Bondout Option	Temperature Range	Package
Device:	MCP120:	Supervisor circuit with open drain output		
	MCP120T:	Supervisor circuit with open drain output (tape & reel)		
	MCP130:	Supervisor circuit with open drain output and internal pull-up resistor		
	MCP130T:	Supervisor circuit with open drain output and internal pull-up resistor (tape & reel)		
<u>RESET/RESET</u> VTRIP Voltage	270 =	2.55 ≤ VTRIP ≤ 2.70		
	300 =	2.85 ≤ VTRIP ≤ 3.00		
	315 =	3.00 ≤ VTRIP ≤ 3.15		
	450 =	4.25 ≤ VTRIP ≤ 4.50		
	460 =	4.35 ≤ VTRIP ≤ 4.60		
	475 =	4.50 ≤ VTRIP ≤ 4.75		
	485 =	4.60 ≤ VTRIP ≤ 4.85		
Bondout Option: (TO-92 Only)	D =	D Bond Option (see bond option chart)		
	F =	F Bond Option		
	G =	G Bond Option		
	H =	H Bond Option		
Temperature Range:	I =	-40°C to +85°C (only offered in I)		
Package:	SN =	SOIC (8-lead, 150 mil body)		
	TO =	TO-92 (3-lead) [offered in bags only]		
	TT =	SOT-23 (3-lead) [offered in tape & reel only]		

**Examples:**

- MCP120-270I/SN = VTRIP range of 2.55V - 2.70V, Industrial Temp., SOIC package
- MCP120-300DI/TO = VTRIP range of 2.85V - 3.00V, Bonding Option D, Industrial Temp., TO-92 package
- MCP120T-315I/TT = VTRIP range of 3.00V - 3.15V, Industrial Temp., SOT-23 package
- MCP130-450I/SN = VTRIP range of 4.25V - 4.50V, Industrial Temp., SOIC package
- MCP130-460FI/TO = VTRIP range of 4.35V - 4.60V, Bonding Option F, Industrial Temp., TO-92 package
- MCP130T-475I/TT = Tape & Reel, VTRIP range of 4.50V - 4.75V, Industrial Temp., SOT-23 package

TO-92 with  
'D' Bondout

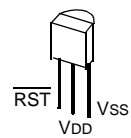

MCP120  
MCP130

TO-92 with  
'F' Bondout

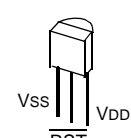

MCP130

TO-92 with  
'G' Bondout

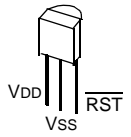

MCP120

TO-92 with  
'H' Bondout

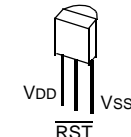

MCP120  
MCP130

## Sales and Support

### Data Sheets

Products supported by a preliminary Data Sheet may have an errata sheet describing minor operational differences and recommended workarounds. To determine if an errata sheet exists for a particular device, please contact one of the following:

- Your local Microchip sales office
- The Microchip Corporate Literature Center U.S. FAX: (480) 792-7277
- The Microchip Worldwide Site ([www.microchip.com](http://www.microchip.com))

Please specify which device, revision of silicon and Data Sheet (include Literature #) you are using.

### New Customer Notification System

Register on our web site ([www.microchip.com/cn](http://www.microchip.com/cn)) to receive the most current information on our products.

“All rights reserved. Copyright © 2001, Microchip Technology Incorporated, USA. Information contained in this publication regarding device applications and the like is intended through suggestion only and may be superseded by updates. No representation or warranty is given and no liability is assumed by Microchip Technology Incorporated with respect to the accuracy or use of such information, or infringement of patents or other intellectual property rights arising from such use or otherwise. Use of Microchip’s products as critical components in life support systems is not authorized except with express written approval by Microchip. No licenses are conveyed, implicitly or otherwise, under any intellectual property rights. The Microchip logo and name are registered trademarks of Microchip Technology Inc. in the U.S.A. and other countries. All rights reserved. All other trademarks mentioned herein are the property of their respective companies. No licenses are conveyed, implicitly or otherwise, under any intellectual property rights.”

## Trademarks

The Microchip name, logo, PIC, PICmicro, PICMASTER, PICSTART, PRO MATE, KEELOQ, SEEVAL, MPLAB and The Embedded Control Solutions Company are registered trademarks of Microchip Technology Incorporated in the U.S.A. and other countries.

Total Endurance, ICSP, In-Circuit Serial Programming, FilterLab, MXDEV, microID, FlexROM, fuzzyLAB, MPASM, MPLINK, MPLIB, PICDEM, ICEPIC, Migratable Memory, FanSense, ECONOMONITOR, SelectMode and microPort are trademarks of Microchip Technology Incorporated in the U.S.A.

Serialized Quick Term Programming (SQTP) is a service mark of Microchip Technology Incorporated in the U.S.A.

All other trademarks mentioned herein are property of their respective companies.

© 2001, Microchip Technology Incorporated, Printed in the U.S.A., All Rights Reserved.



*Microchip received QS-9000 quality system certification for its worldwide headquarters, design and wafer fabrication facilities in Chandler and Tempe, Arizona in July 1999. The Company's quality system processes and procedures are QS-9000 compliant for its PICmicro® 8-bit MCUs, KEELOQ® code hopping devices, Serial EEPROMs and microperipheral products. In addition, Microchip's quality system for the design and manufacture of development systems is ISO 9001 certified.*



# MICROCHIP

## WORLDWIDE SALES AND SERVICE

### AMERICAS

#### Corporate Office

2355 West Chandler Blvd.  
Chandler, AZ 85224-6199  
Tel: 480-792-7200 Fax: 480-792-7277  
Technical Support: 480-792-7627  
Web Address: <http://www.microchip.com>

#### Rocky Mountain

2355 West Chandler Blvd.  
Chandler, AZ 85224-6199  
Tel: 480-792-7966 Fax: 480-792-7456

#### Atlanta

500 Sugar Mill Road, Suite 200B  
Atlanta, GA 30350  
Tel: 770-640-0034 Fax: 770-640-0307

#### Austin

Analog Product Sales  
8303 MoPac Expressway North  
Suite A-201  
Austin, TX 78759  
Tel: 512-345-2030 Fax: 512-345-6085

#### Boston

2 Lan Drive, Suite 120  
Westford, MA 01886  
Tel: 978-692-3848 Fax: 978-692-3821

#### Boston

Analog Product Sales  
Unit A-8-1 Millbrook Tarry Condominium  
97 Lowell Road  
Concord, MA 01742  
Tel: 978-371-6400 Fax: 978-371-0050

#### Chicago

333 Pierce Road, Suite 180  
Itasca, IL 60143  
Tel: 630-285-0071 Fax: 630-285-0075

#### Dallas

4570 Westgrove Drive, Suite 160  
Addison, TX 75001  
Tel: 972-818-7423 Fax: 972-818-2924

#### Dayton

Two Prestige Place, Suite 130  
Miamisburg, OH 45342  
Tel: 937-291-1654 Fax: 937-291-9175

#### Detroit

Tri-Atria Office Building  
32255 Northwestern Highway, Suite 190  
Farmington Hills, MI 48334  
Tel: 248-538-2250 Fax: 248-538-2260

#### Los Angeles

18201 Von Karman, Suite 1090  
Irvine, CA 92612  
Tel: 949-263-1888 Fax: 949-263-1338

#### Mountain View

Analog Product Sales  
1300 Terra Bella Avenue  
Mountain View, CA 94043-1836  
Tel: 650-968-9241 Fax: 650-967-1590

#### New York

150 Motor Parkway, Suite 202  
Hauppauge, NY 11788  
Tel: 631-273-5305 Fax: 631-273-5335

#### San Jose

Microchip Technology Inc.  
2107 North First Street, Suite 590  
San Jose, CA 95131  
Tel: 408-436-7950 Fax: 408-436-7955

#### Toronto

6285 Northam Drive, Suite 108  
Mississauga, Ontario L4V 1X5, Canada  
Tel: 905-673-0699 Fax: 905-673-6509

### ASIA/PACIFIC

#### Australia

Microchip Technology Australia Pty Ltd  
Suite 22, 41 Rawson Street  
Epping 2121, NSW  
Australia  
Tel: 61-2-9868-6733 Fax: 61-2-9868-6755

#### China - Beijing

Microchip Technology Beijing Office  
Unit 915  
New China Hong Kong Manhattan Bldg.  
No. 6 Chaoyangmen Beidajie  
Beijing, 100027, No. China  
Tel: 86-10-85282100 Fax: 86-10-85282104

#### China - Shanghai

Microchip Technology Shanghai Office  
Room 701, Bldg. B  
Far East International Plaza  
No. 317 Xian Xia Road  
Shanghai, 200051  
Tel: 86-21-6275-5700 Fax: 86-21-6275-5060

#### Hong Kong

Microchip Asia Pacific  
RM 2101, Tower 2, Metroplaza  
223 Hing Fong Road  
Kwai Fong, N.T., Hong Kong  
Tel: 852-2401-1200 Fax: 852-2401-3431

#### India

Microchip Technology Inc.  
India Liaison Office  
Divyasree Chambers  
1 Floor, Wing A (A3/A4)  
No. 11, O'Shaughnessey Road  
Bangalore, 560 025, India  
Tel: 91-80-2290061 Fax: 91-80-2290062

#### Japan

Microchip Technology Intl. Inc.  
Benex S-1 6F  
3-18-20, Shinyokohama  
Kohoku-Ku, Yokohama-shi  
Kanagawa, 222-0033, Japan  
Tel: 81-45-471-6166 Fax: 81-45-471-6122

### ASIA/PACIFIC (continued)

#### Korea

Microchip Technology Korea  
168-1, Youngbo Bldg. 3 Floor  
Samsung-Dong, Kangnam-Ku  
Seoul, Korea  
Tel: 82-2-554-7200 Fax: 82-2-558-5934

#### Singapore

Microchip Technology Singapore Pte Ltd.  
200 Middle Road  
#07-02 Prime Centre  
Singapore, 188980  
Tel: 65-334-8870 Fax: 65-334-8850

#### Taiwan

Microchip Technology Taiwan  
11F-3, No. 207  
Tung Hua North Road  
Taipei, 105, Taiwan  
Tel: 886-2-2717-7175 Fax: 886-2-2545-0139

### EUROPE

#### Denmark

Microchip Technology Denmark ApS  
Regus Business Centre  
Lautrup høj 1-3  
Ballerup DK-2750 Denmark  
Tel: 45 4420 9895 Fax: 45 4420 9910

#### France

Arizona Microchip Technology SARL  
Parc d'Activite du Moulin de Massy  
43 Rue du Saule Trapu  
Batiment A - 1er Etage  
91300 Massy, France  
Tel: 33-1-69-53-63-20 Fax: 33-1-69-30-90-79

#### Germany

Arizona Microchip Technology GmbH  
Gustav-Heinemann Ring 125  
D-81739 Munich, Germany  
Tel: 49-89-627-144 0 Fax: 49-89-627-144-44

#### Germany

Analog Product Sales  
Lochhamer Strasse 13  
D-82152 Martinsried, Germany  
Tel: 49-89-895650-0 Fax: 49-89-895650-22

#### Italy

Arizona Microchip Technology SRL  
Centro Direzionale Colleoni  
Palazzo Taurus 1 V. Le Colleoni 1  
20041 Agrate Brianza  
Milan, Italy  
Tel: 39-039-65791-1 Fax: 39-039-6899883

#### United Kingdom

Arizona Microchip Technology Ltd.  
505 Eskdale Road  
Winnersh Triangle  
Wokingham  
Berkshire, England RG41 5TU  
Tel: 44 118 921 5869 Fax: 44-118 921-5820

01/30/01

All rights reserved. © 2001 Microchip Technology Incorporated. Printed in the USA. 2/01 Printed on recycled paper.

Information contained in this publication regarding device applications and the like is intended through suggestion only and may be superseded by updates. It is your responsibility to ensure that your application meets with your specifications. No representation or warranty is given and no liability is assumed by Microchip Technology Incorporated with respect to the accuracy or use of such information, or infringement of patents or other intellectual property rights arising from such use or otherwise. Use of Microchip's products as critical components in life support systems is not authorized except with express written approval by Microchip. No licenses are conveyed, implicitly or otherwise, except as maybe explicitly expressed herein, under any intellectual property rights. The Microchip logo and name are registered trademarks of Microchip Technology Inc. in the U.S.A. and other countries. All rights reserved. All other trademarks mentioned herein are the property of their respective companies.