

---

---

## 6A High-Speed Power MOSFET Drivers

---

---

### Features

- High Peak Output Current: 6.0A (typical)
- Low Shoot-Through/Cross-Conduction Current in Output Stage
- Wide Input Supply Voltage Operating Range:
  - 4.5V to 18V
- High Capacitive Load Drive Capability:
  - 2500 pF in 20 ns
  - 6800 pF in 40 ns
- Short Delay Times: 40 ns (typical)
- Matched Rise/Fall Times
- Low Supply Current:
  - With Logic '1' Input – 130  $\mu$ A (typical)
  - With Logic '0' Input – 35  $\mu$ A (typical)
- Latch-Up Protected: Will Withstand 1.5A Reverse Current
- Logic Input Will Withstand Negative Swing up to 5V
- Pin compatible with the TC4420/TC4429 devices
- Space-saving 8-Pin SOIC, PDIP and 8-Pin 6 x 5 mm DFN Packages

### Applications

- Switch Mode Power Supplies
- Pulse Transformer Drive
- Line Drivers
- Motor and Solenoid Drive

### General Description

The MCP1406/07 devices are a family of buffers/MOSFET drivers that feature a single-output with 6A peak drive current capability, low shoot-through current, matched rise/fall times and propagation delay times. These devices are pin-compatible and are improved versions of the TC4420/TC4429 MOSFET drivers.

The MCP1406/07 MOSFET drivers can easily charge and discharge 2500 pF gate capacitance in under 20 ns, provide low enough impedances (in both the ON and OFF states) to ensure that intended state of the MOSFETs will not be affected, even by large transients. The input to the MCP1406/07 may be driven directly from either TTL or CMOS (3V to 18V).

These devices are highly latch-up resistant under any conditions that fall within their power and voltage ratings. They are not subject to damage when up to 5V of noise spiking (of either polarity) occurs on the ground pin. All terminals are fully protected against electrostatic discharge (ESD), up to 2.0 kV (HBM) and 400V (MM).

The MCP1406/07 single-output 6A MOSFET driver family is offered in both surface-mount and pin-through-hole packages with a -40°C to +125°C temperature rating, making it useful in any wide temperature range application.

# MCP1406/07

## Package Types

### 8-Pin PDIP/SOIC

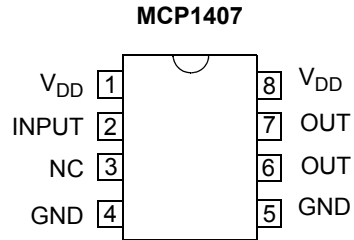
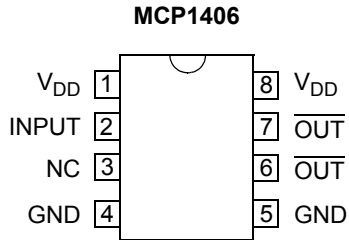

### 8-Pin 6x5 DFN-S<sup>(2)</sup>

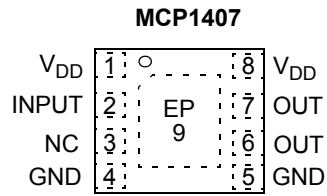
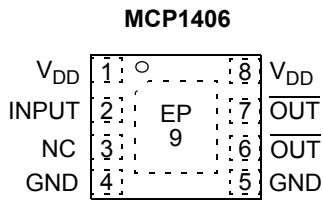

### 5-Pin TO-220

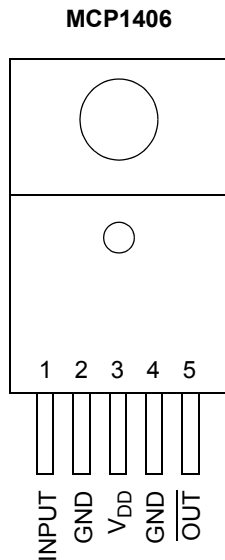

Tab is common to V<sub>DD</sub>

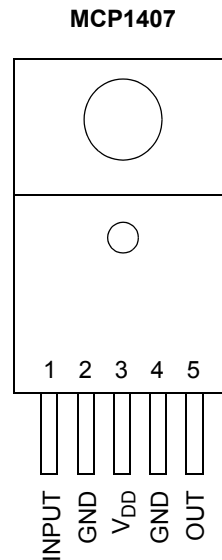

**Note 1:** Duplicate pins must both be connected for proper operation.

**2:** Exposed pad of the DFN package is electrically isolated; see [Table 3-1](#).

## Functional Block Diagram<sup>(1)</sup>

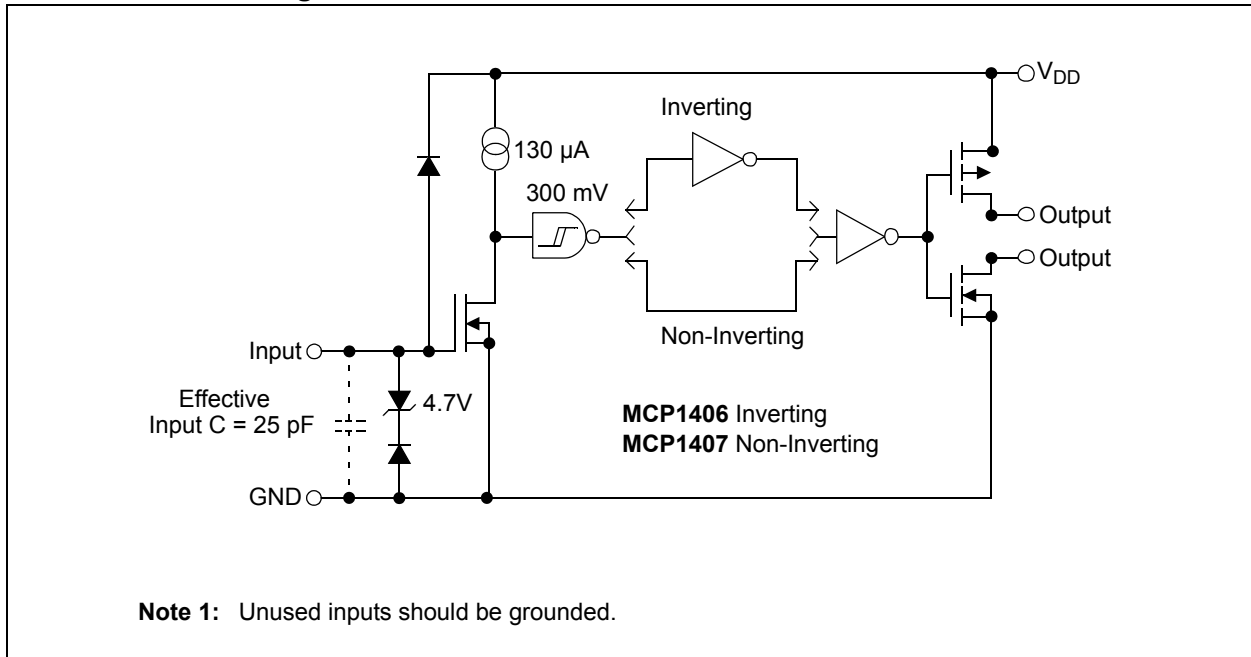

# MCP1406/07

## 1.0 ELECTRICAL CHARACTERISTICS

### Absolute Maximum Ratings †

Supply Voltage .....	+20V
Input Voltage .....	(V <sub>DD</sub> +0.3V) to (GND -5V)
Input Current (V <sub>IN</sub> > V <sub>DD</sub> ) .....	50 mA
Package Power Dissipation (TA ≤ +70°C)	
DFN-S .....	2.5W
PDIP .....	1.2W
SOIC .....	0.83W
TO-220 .....	3.9W
ESD Protection on all Pins .....	2 kV (HBM), 400V (MM)

† **Notice:** Stresses above those listed under “Maximum Ratings” may cause permanent damage to the device. This is a stress rating only and functional operation of the device at those or any other conditions above those indicated in the operational sections of this specification is not intended. Exposure to maximum rating conditions for extended periods may affect device reliability.

### DC CHARACTERISTICS

Electrical Specifications: Unless otherwise indicated, T <sub>A</sub> = +25°C, with 4.5V ≤ V <sub>DD</sub> ≤ 18V.						
Parameters	Sym.	Min.	Typ.	Max.	Units	Conditions
<b>Input</b>						
Logic '1', High Input Voltage	V <sub>IH</sub>	2.4	1.8	—	V	
Logic '0', Low Input Voltage	V <sub>IL</sub>	—	1.3	0.8	V	
Input Current	I <sub>IN</sub>	-10	—	10	μA	0V ≤ V <sub>IN</sub> ≤ V <sub>DD</sub>
Input Voltage	V <sub>IN</sub>	-5	—	V <sub>DD</sub> + 0.3	V	
<b>Output</b>						
High Output Voltage	V <sub>OH</sub>	V <sub>DD</sub> - 0.025	—	—	V	DC Test
Low Output Voltage	V <sub>OL</sub>	—	—	0.025	V	DC Test
Output Resistance, High	R <sub>OH</sub>	—	2.1	2.8	Ω	I <sub>OUT</sub> = 10 mA, V <sub>DD</sub> = 18V
Output Resistance, Low	R <sub>OL</sub>	—	1.5	2.5	Ω	I <sub>OUT</sub> = 10 mA, V <sub>DD</sub> = 18V
Peak Output Current	I <sub>PK</sub>	—	6	—	A	V <sub>DD</sub> = 18V ( <b>Note 1</b> )
Continuous Output Current	I <sub>DC</sub>	1.3	—	—	A	<b>Note 1, Note 2</b>
Latch-Up Protection Withstand Reverse Current	I <sub>REV</sub>	—	1.5	—	A	Duty cycle ≤ 2%, t ≤ 300 μs
<b>Switching Time (<b>Note 3</b>)</b>						
Rise Time	t <sub>R</sub>	—	20	30	ns	<b>Figure 4-1, Figure 4-2</b> C <sub>L</sub> = 2500 pF
Fall Time	t <sub>F</sub>	—	20	30	ns	<b>Figure 4-1, Figure 4-2</b> C <sub>L</sub> = 2500 pF
Delay Time	t <sub>D1</sub>	—	40	55	ns	<b>Figure 4-1, Figure 4-2</b>
Delay Time	t <sub>D2</sub>	—	40	55	ns	<b>Figure 4-1, Figure 4-2</b>
<b>Power Supply</b>						
Supply Voltage	V <sub>DD</sub>	4.5	—	18.0	V	
Power Supply Current	I <sub>S</sub>	—	130	250	μA	V <sub>IN</sub> = 3V
	I <sub>S</sub>	—	35	100	μA	V <sub>IN</sub> = 0V

**Note 1:** Tested during characterization, not production tested.

**2:** Valid for AT (TO-220) and MF (DFN-S) packages only. T<sub>A</sub> = +25°C

**3:** Switching times ensured by design.

## DC CHARACTERISTICS (OVER OPERATING TEMPERATURE RANGE)

Electrical Specifications: Unless otherwise indicated, operating temperature range with $4.5V \leq V_{DD} \leq 18V$ .						
Parameters	Sym.	Min.	Typ.	Max.	Units	Conditions
<b>Input</b>						
Logic '1', High Input Voltage	$V_{IH}$	2.4	—	—	V	
Logic '0', Low Input Voltage	$V_{IL}$	—	—	0.8	V	
Input Current	$I_{IN}$	-10	—	+10	$\mu A$	$0V \leq V_{IN} \leq V_{DD}$
Input Voltage	$V_{IN}$	-5	—	$V_{DD}+0.3$	V	
<b>Output</b>						
High Output Voltage	$V_{OH}$	$V_{DD} - 0.025$	—	—	V	DC TEST
Low Output Voltage	$V_{OL}$	—	—	0.025	V	DC TEST
Output Resistance, High	$R_{OH}$	—	3.0	5.0	$\Omega$	$I_{OUT} = 10 \text{ mA}, V_{DD} = 18V$
Output Resistance, Low	$R_{OL}$	—	2.3	5.0	$\Omega$	$I_{OUT} = 10 \text{ mA}, V_{DD} = 18V$
<b>Switching Time (Note 1)</b>						
Rise Time	$t_R$	—	25	40	ns	Figure 4-1, Figure 4-2 $C_L = 2500 \text{ pF}$
Fall Time	$t_F$	—	25	40	ns	Figure 4-1, Figure 4-2 $C_L = 2500 \text{ pF}$
Delay Time	$t_{D1}$	—	50	65	ns	Figure 4-1, Figure 4-2
Delay Time	$t_{D2}$	—	50	65	ns	Figure 4-1, Figure 4-2
<b>Power Supply</b>						
Supply Voltage	$V_{DD}$	4.5	—	18.0	V	
Power Supply Current	$I_S$	—	200	500	$\mu A$	$V_{IN} = 3V$
		—	50	150		$V_{IN} = 0V$

**Note 1:** Switching times ensured by design.

# MCP1406/07

## TEMPERATURE CHARACTERISTICS

Electrical Specifications: Unless otherwise noted, all parameters apply with $4.5V \leq V_{DD} \leq 18V$ .						
Parameters	Sym.	Min.	Typ.	Max.	Units	Conditions
<b>Temperature Ranges</b>						
Specified Temperature Range	$T_A$	-40	—	+125	°C	
Maximum Junction Temperature	$T_J$	—	—	+150	°C	
Storage Temperature Range	$T_A$	-65	—	+150	°C	
<b>Package Thermal Resistances</b>						
Junction-to-Ambient Thermal Resistance, 8-L 6x5 DFN	$\theta_{JA}$	—	31.8	—	°C/W	Note 1
Junction-to-Ambient Thermal Resistance, 8-L PDIP	$\theta_{JA}$	—	65.2	—	°C/W	Note 1
Junction-to-Ambient Thermal Resistance, 8-L SOIC	$\theta_{JA}$	—	96.3	—	°C/W	Note 1
Junction-to-Ambient Thermal Resistance, 5-L TO-220	$\theta_{JA}$	—	20.1	—	°C/W	Note 1
Junction-to-Case (Bottom) Thermal Resistance, 5-L TO-220	$\theta_{JC(BOT)}$		3.2	—	°C/W	Note 2
Junction-to-Top Characterization Parameter, 8-L 6x5 DFN	$\Psi_{JT}$		0.2	—	°C/W	Note 1
Junction-to-Top Characterization Parameter, 8-L PDIP	$\Psi_{JT}$		8.8	—	°C/W	Note 1
Junction-to-Top Characterization Parameter, 8-L SOIC	$\Psi_{JT}$		3.2	—	°C/W	Note 1
Junction-to-Top Characterization Parameter, 5-L TO-220	$\Psi_{JT}$		3.6	—	°C/W	Note 1
Junction-to-Board Characterization Parameter, 8-L 6x5 DFN	$\Psi_{JB}$		15.5	—	°C/W	Note 1
Junction-to-Board Characterization Parameter, 8-L PDIP	$\Psi_{JB}$		36.1	—	°C/W	Note 1
Junction-to-Board Characterization Parameter, 8-L SOIC	$\Psi_{JB}$		60.7	—	°C/W	Note 1
Junction-to-Board Characterization Parameter, 5-L TO-220	$\Psi_{JB}$		4.0	—	°C/W	Note 1

**Note 1:** Parameter is determined using a High 2S2P 4-layer board, as described in JESD 51-7, as well as in JESD 51-5, for packages with exposed pads.

**2:** Parameter is determined using a 1S0P 2-layer board with a cold plate attached to indicated location.

## 2.0 TYPICAL PERFORMANCE CURVES

**Note:** The graphs and tables provided following this note are a statistical summary based on a limited number of samples and are provided for informational purposes only. The performance characteristics listed herein are not tested or guaranteed. In some graphs or tables, the data presented may be outside the specified operating range (e.g., outside specified power supply range) and therefore outside the warranted range.

**Note:** Unless otherwise indicated,  $T_A = +25^\circ\text{C}$  with  $4.5\text{V} \leq V_{DD} \leq 18\text{V}$ .

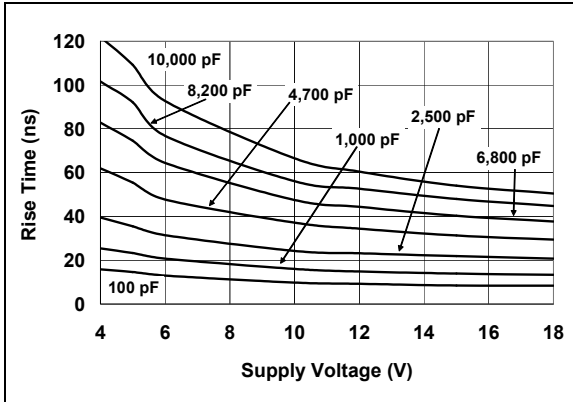

**FIGURE 2-1:** Rise Time vs. Supply Voltage.

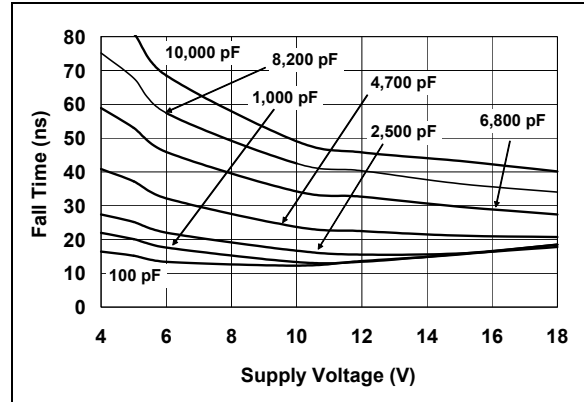

**FIGURE 2-4:** Fall Time vs. Supply Voltage.

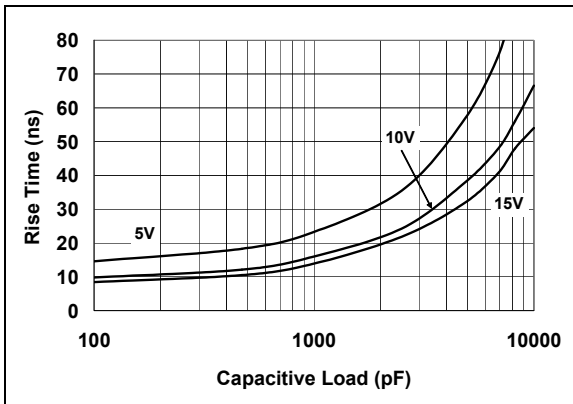

**FIGURE 2-2:** Rise Time vs. Capacitive Load.

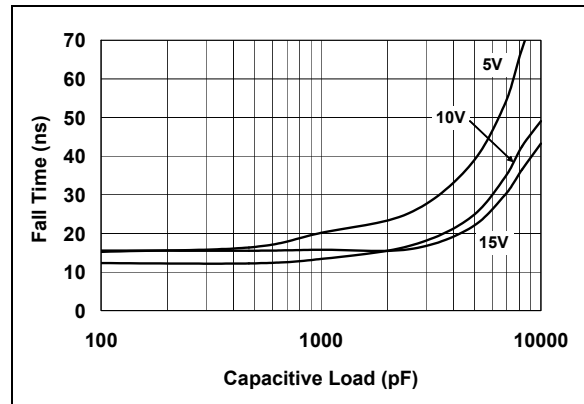

**FIGURE 2-5:** Fall Time vs. Capacitive Load.

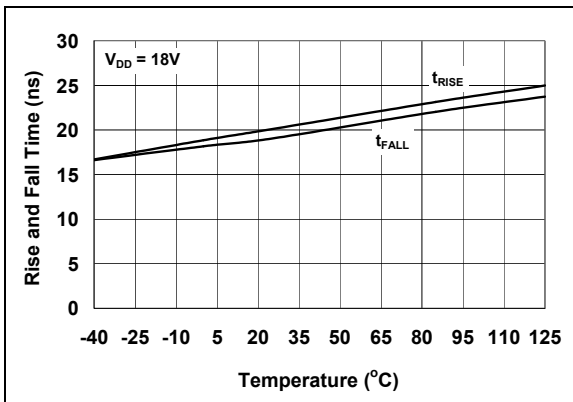

**FIGURE 2-3:** Rise and Fall Times vs. Temperature.

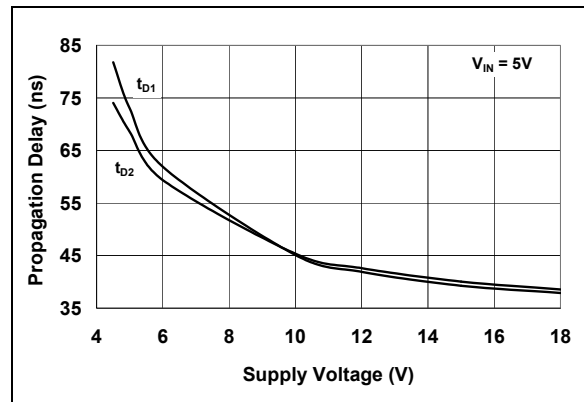

**FIGURE 2-6:** Propagation Delay vs. Supply Voltage.

# MCP1406/07

Note: Unless otherwise indicated,  $T_A = +25^\circ\text{C}$  with  $4.5\text{V} \leq V_{DD} \leq 18\text{V}$ .

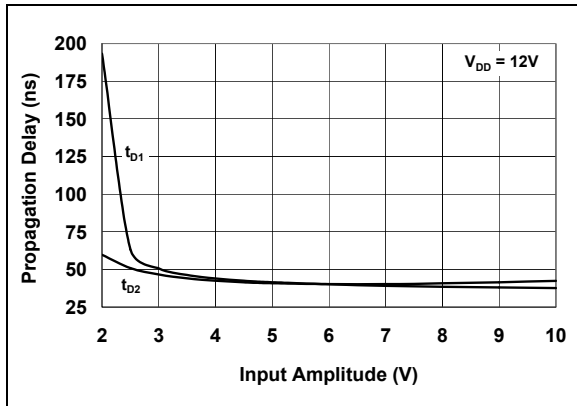

**FIGURE 2-7:** Propagation Delay Time vs. Input Amplitude.

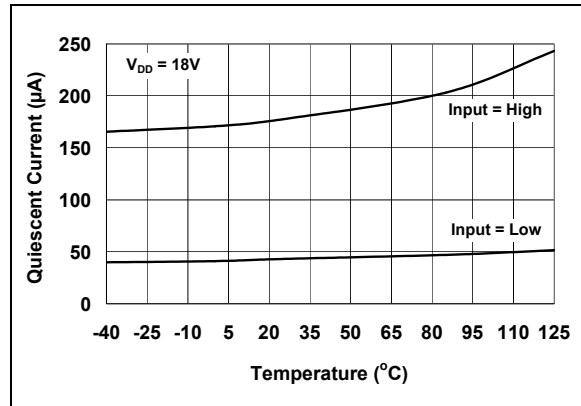

**FIGURE 2-10:** Quiescent Current vs. Temperature.

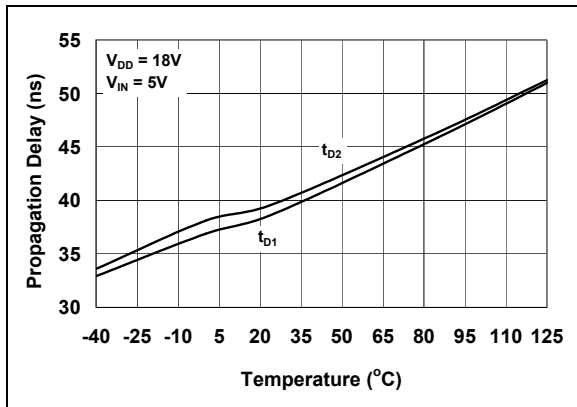

**FIGURE 2-8:** Propagation Delay Time vs. Temperature.

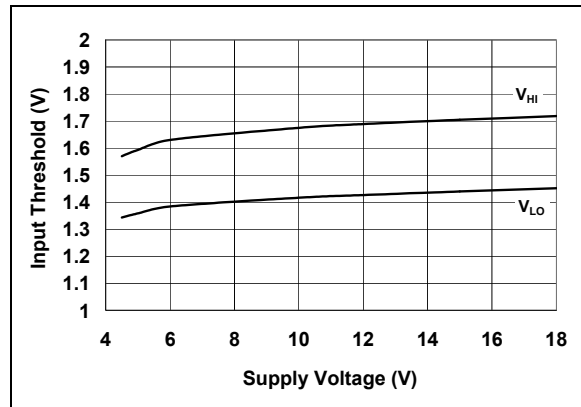

**FIGURE 2-11:** Input Threshold vs. Supply Voltage.

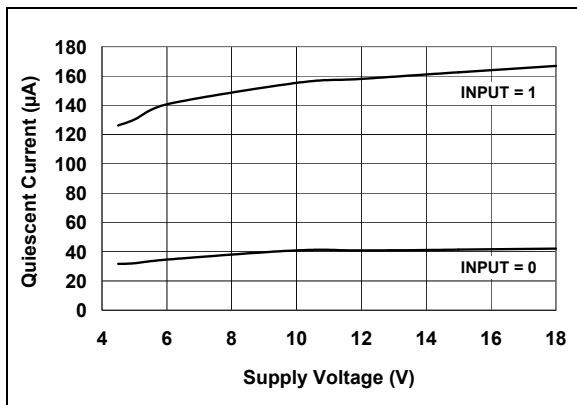

**FIGURE 2-9:** Quiescent Current vs. Supply Voltage.

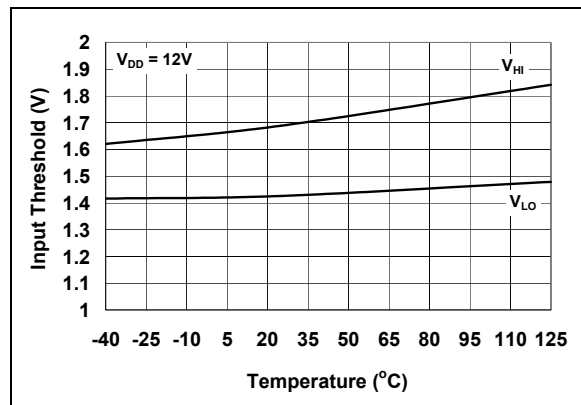

**FIGURE 2-12:** Input Threshold vs. Temperature.



**Note:** Unless otherwise indicated,  $T_A = +25^\circ\text{C}$  with  $4.5\text{V} \leq V_{DD} \leq 18\text{V}$ .

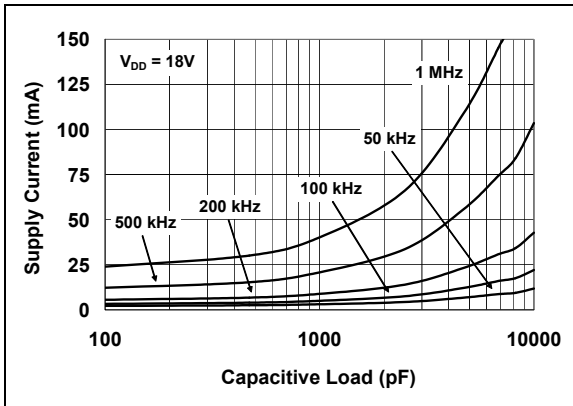

**FIGURE 2-13:** Supply Current vs. Capacitive Load.

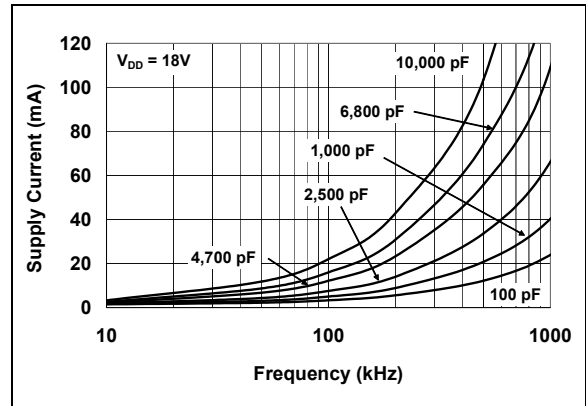

**FIGURE 2-16:** Supply Current vs. Frequency.

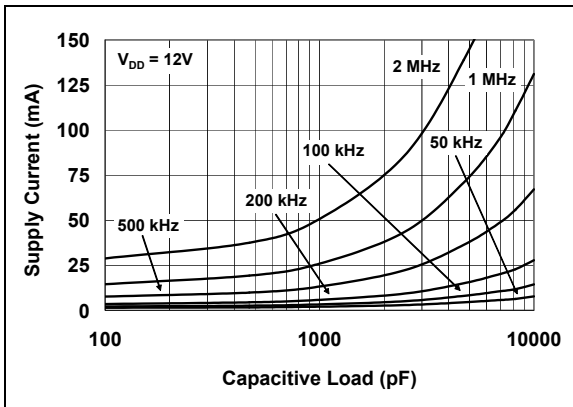

**FIGURE 2-14:** Supply Current vs. Capacitive Load.

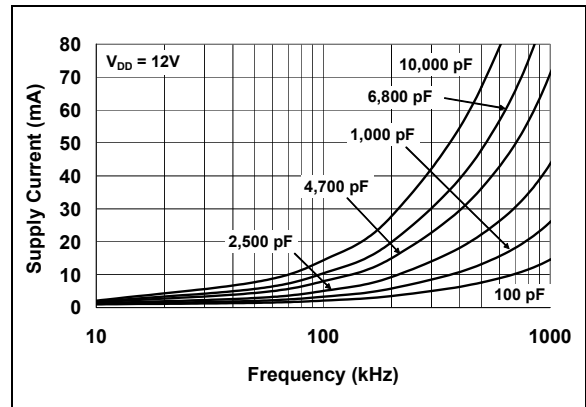

**FIGURE 2-17:** Supply Current vs. Frequency.

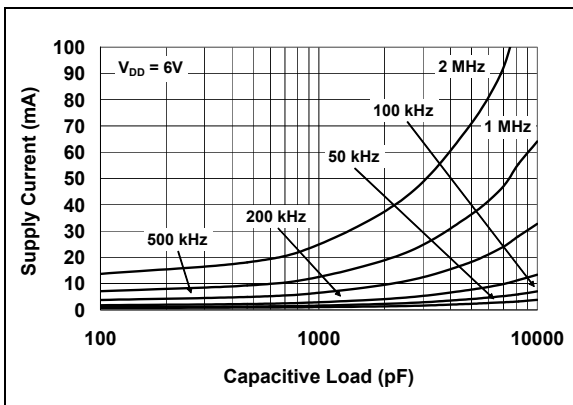

**FIGURE 2-15:** Supply Current vs. Capacitive Load.

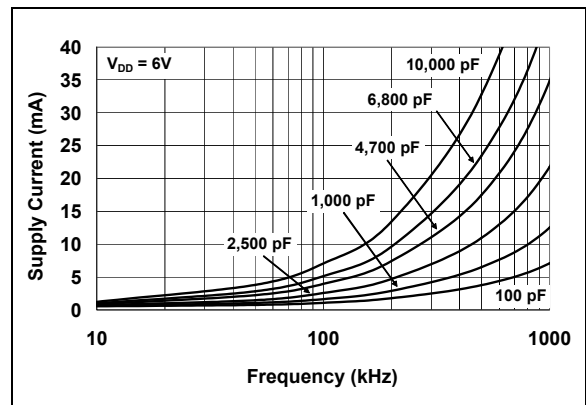

**FIGURE 2-18:** Supply Current vs. Frequency.

# MCP1406/07

Note: Unless otherwise indicated,  $T_A = +25^\circ\text{C}$  with  $4.5\text{V} \leq V_{DD} \leq 18\text{V}$ .

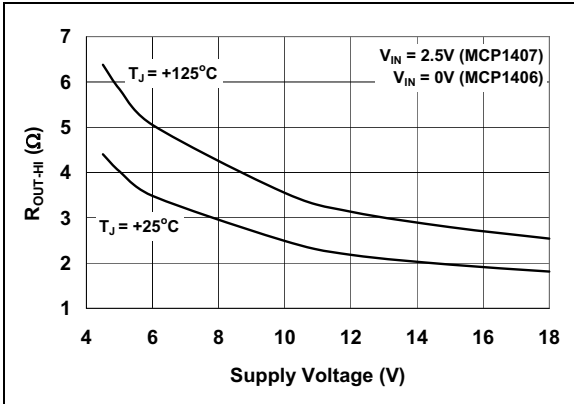

**FIGURE 2-19:** Output Resistance (Output High) vs. Supply Voltage.

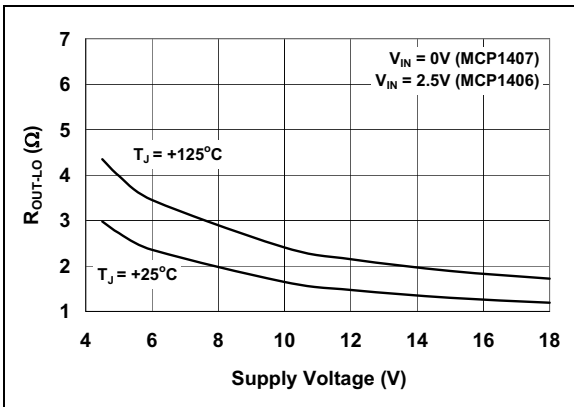

**FIGURE 2-20:** Output Resistance (Output Low) vs. Supply Voltage.

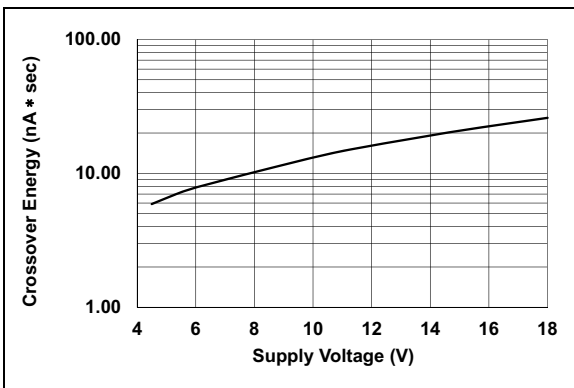

**FIGURE 2-21:** Crossover Energy vs. Supply Voltage.

## 3.0 PIN DESCRIPTIONS

The descriptions of the pins are listed in [Table 3-1](#).

**TABLE 3-1: PIN FUNCTION TABLE<sup>(1)</sup>**

5-Pin TO-220	8-Pin 6x5 DFN	8-Pin PDIP, SOIC	Symbol	Description
—	1	1	V <sub>DD</sub>	Supply Input
1	2	2	INPUT	Control Input
—	3	3	NC	No Connection
2	4	4	GND	Ground
4	5	5	GND	Ground
5	6	6	OUTPUT	CMOS Push-Pull Output
—	7	7	OUTPUT	CMOS Push-Pull Output
3	8	8	V <sub>DD</sub>	Supply Input
—	9	—	EP	Exposed Metal Pad
TAB	—	—	V <sub>DD</sub>	Metal Tab at V <sub>DD</sub> Potential

**Note 1:** Duplicate pins must be connected for proper operation.

### 3.1 Supply Input (V<sub>DD</sub>)

V<sub>DD</sub> is the bias supply input for the MOSFET driver and has a voltage range of 4.5V to 18V. This input must be decoupled to ground with local capacitors. The bypass capacitors provide a localized low-impedance path for the peak currents that are to be provided to the load.

### 3.2 Control Input (INPUT)

The MOSFET driver input is a high-impedance, TTL/CMOS-compatible input. The input also has hysteresis between the high and low input levels, allowing them to be driven from slow rising and falling signals, and to provide noise immunity.

### 3.3 Ground (GND)

Ground is the device return pin. The ground pin should have a low impedance connection to the bias supply source return. High peak currents will flow out the ground pin when the capacitive load is being discharged.

### 3.4 CMOS Push-Pull Output (OUTPUT)

The output is a CMOS push-pull output that is capable of sourcing peak currents of 6A (V<sub>DD</sub> = 18V). The low output impedance ensures the gate of the external MOSFET will stay in the intended state even during large transients. The output pins also have reverse current latch-up ratings of 1.5A.

### 3.5 Exposed Metal Pad (6x5 DFN only)

The exposed metal pad of the DFN package is not internally connected to any potential. Therefore, this pad can be connected to a ground plane or other copper plane on a printed circuit board to aid in heat removal from the package.

### 3.6 TO-220 Metal Tab

The metal tab on the TO-220 package is at V<sub>DD</sub> potential. This metal tab is not intended to be the V<sub>DD</sub> connection to MCP1406/07. V<sub>DD</sub> should be supplied using the Supply Input pin of the TO-220.

# MCP1406/07

## 4.0 APPLICATION INFORMATION

### 4.1 General Information

MOSFET drivers are high-speed, high current devices which are intended to provide high peak currents to charge the gate capacitance of external MOSFETs or IGBTs. In high frequency switching power supplies, the PWM controller may not have the drive capability to directly drive the power MOSFET. A MOSFET driver like the MCP1406/07 family can be used to provide additional drive current capability.

### 4.2 MOSFET Driver Timing

The ability of a MOSFET driver to transition from a fully-OFF state to a fully-ON state are characterized by the drivers' rise time ( $t_R$ ), fall time ( $t_F$ ) and propagation delays ( $t_{D1}$  and  $t_{D2}$ ). The MCP1406/07 family of devices is able to make this transition very quickly. Figure 4-1 and Figure 4-2 show the test circuits and timing waveforms used to verify the MCP1406/07 timing.

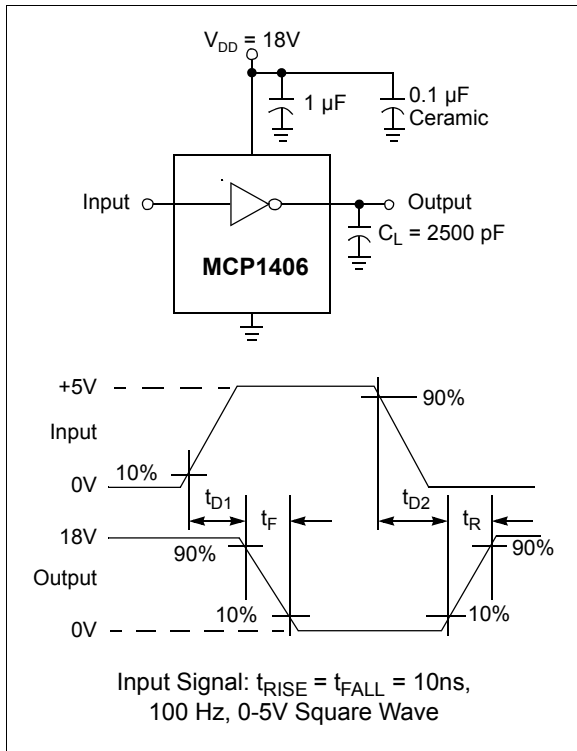

**FIGURE 4-1:** Inverting Driver Timing Waveform.

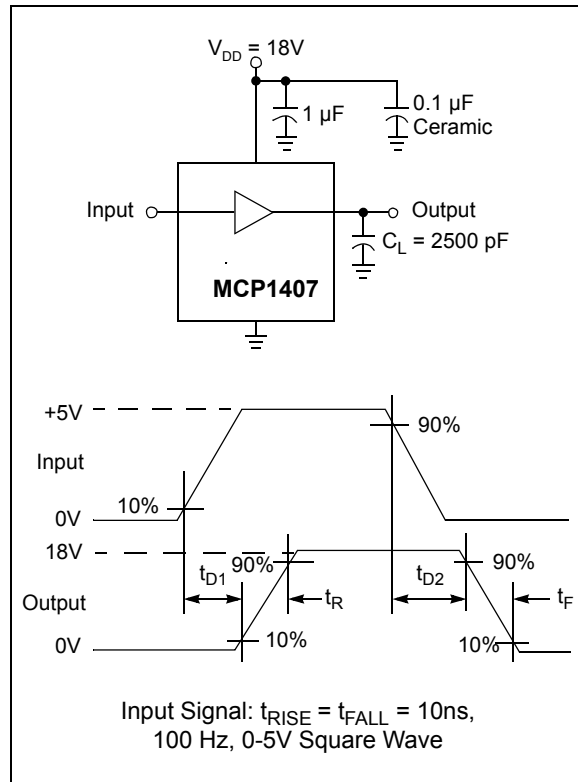

**FIGURE 4-2:** Non-Inverting Driver Timing Waveform.

### 4.3 Decoupling Capacitors

Careful layout and decoupling capacitors are highly recommended when using MOSFET drivers. Large currents are required to charge and discharge capacitive loads quickly. For example, 2.25A are needed to charge a 2500 pF load with 18V in 20 ns.

To operate the MOSFET driver over a wide frequency range with low supply impedance, a ceramic and a low ESR film capacitor are recommended to be placed in parallel between the driver  $V_{DD}$  and the GND. A 1.0 µF low ESR film capacitor and a 0.1 µF ceramic capacitor placed between pins 1, 8 and 4, 5 should be used. These capacitors should be placed close to the driver to minimize circuit board parasitics and provide a local source for the required current.

## 4.4 PCB Layout Considerations

Proper PCB layout is important in a high current, fast switching circuit to provide proper device operation and robustness of design. PCB trace loop area and inductance should be minimized by the use of a ground plane or ground trace located under the MOSFET gate drive signals, separate analog and power grounds, and local driver decoupling.

The MCP1406/07 devices have two pins each for  $V_{DD}$ , OUTPUT and GND. Both pins must be used for proper operation. This also lowers path inductance which will, along with proper decoupling, help minimize ringing in the circuit.

Placing a ground plane beneath the MCP1406/07 will help as a radiated noise shield as well as providing some heat sinking for power dissipated within the device.

## 4.5 Power Dissipation

The total internal power dissipation in a MOSFET driver is the summation of three separate power dissipation elements, which can be calculated by using the following equation:

### EQUATION 4-1:

$$P_T = P_L + P_Q + P_{CC}$$

Where:

- $P_T$  = Total power dissipation
- $P_L$  = Load power dissipation
- $P_Q$  = Quiescent power dissipation
- $P_{CC}$  = Operating power dissipation

### 4.5.1 CAPACITIVE LOAD DISSIPATION

The power dissipation caused by a capacitive load is a direct function of frequency, total capacitive load and supply voltage. The power lost in the MOSFET driver for a complete charging and discharging cycle of a MOSFET can be determined by means of this equation:

### EQUATION 4-2:

$$P_L = f \times C_T \times V_{DD}^2$$

Where:

- $f$  = Switching frequency
- $C_T$  = Total load capacitance
- $V_{DD}$  = MOSFET driver supply voltage

### 4.5.2 QUIESCENT POWER DISSIPATION

The power dissipation associated with the quiescent current draw depends on the state of the input pin. The MCP1406/07 devices have a quiescent current draw when the input is high of 0.13 mA (typ) and 0.035 mA (typ) when the input is low. The quiescent power dissipation can be determined by using this equation:

### EQUATION 4-3:

$$P_Q = (I_{QH} \times D + I_{QL} \times (1 - D)) \times V_{DD}$$

Where:

- $I_{QH}$  = Quiescent current in the high state
- $D$  = Duty cycle
- $I_{QL}$  = Quiescent current in the low state
- $V_{DD}$  = MOSFET driver supply voltage

### 4.5.3 OPERATING POWER DISSIPATION

The operating power dissipation occurs each time the MOSFET driver output transitions; this is because, for a very short period of time, both MOSFETs in the output stage are ON simultaneously. This cross-conduction current leads to a power dissipation, as described by the following equation:

### EQUATION 4-4:

$$P_{CC} = CC \times f \times V_{DD}$$

Where:

- $CC$  = Cross-conduction constant (A sec.)
- $f$  = Switching frequency
- $V_{DD}$  = MOSFET driver supply voltage

# MCP1406/07

## 5.0 PACKAGING INFORMATION

### 5.1 Package Marking Information (Not to Scale)

8-Lead SOIC (3.90 mm)

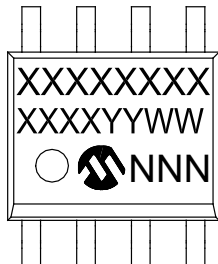

Example

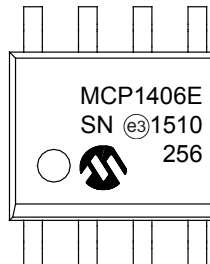

5-Lead TO-220

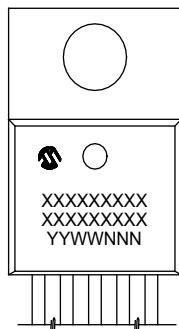

Example

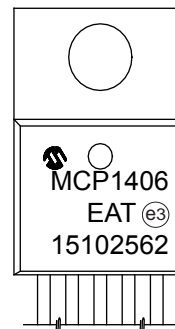

8-Lead DFN-S (6x5x0.9 mm)



Example

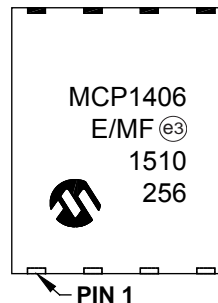

<b>Legend:</b>	XX...X	Customer-specific information
	Y	Year code (last digit of calendar year)
	YY	Year code (last 2 digits of calendar year)
	WW	Week code (week of January 1 is week '01')
	NNN	Alphanumeric traceability code
	(e3)	Pb-free JEDEC designator for Matte Tin (Sn)
	*	This package is Pb-free. The Pb-free JEDEC designator (e3) can be found on the outer packaging for this package.

**Note:** In the event the full Microchip part number cannot be marked on one line, it will be carried over to the next line, thus limiting the number of available characters for customer-specific information.

8-Lead PDIP (300 mil)

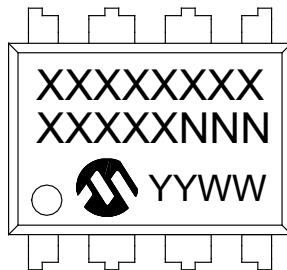

Example

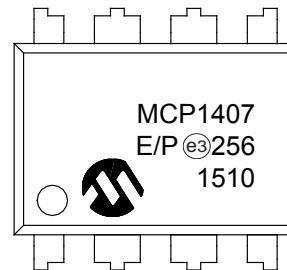

<b>Legend:</b>	XX...X	Customer-specific information
	Y	Year code (last digit of calendar year)
	YY	Year code (last 2 digits of calendar year)
	WW	Week code (week of January 1 is week '01')
	NNN	Alphanumeric traceability code
	(e3)	Pb-free JEDEC designator for Matte Tin (Sn)
	*	This package is Pb-free. The Pb-free JEDEC designator (e3) can be found on the outer packaging for this package.

**Note:** In the event the full Microchip part number cannot be marked on one line, it will be carried over to the next line, thus limiting the number of available characters for customer-specific information.

# MCP1406/07

## 5-Lead Plastic Transistor Outline (AT) [TO-220]

**Note:** For the most current package drawings, please see the Microchip Packaging Specification located at <http://www.microchip.com/packaging>

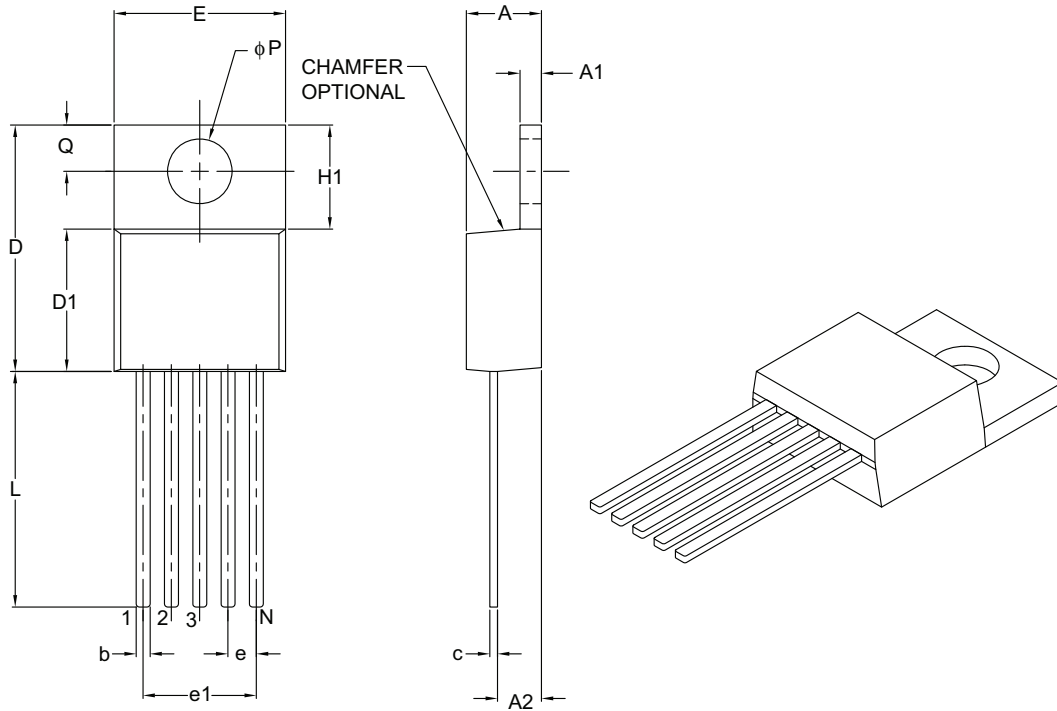

Dimension Limits	Units	INCHES		
		MIN	NOM	MAX
Number of Pins	N	5		
Pitch	e	.067 BSC		
Overall Pin Pitch	e1	.268 BSC		
Overall Height	A	.140	–	.190
Overall Width	E	.380	–	.420
Overall Length	D	.560	–	.650
Molded Package Length	D1	.330	–	.355
Tab Length	H1	.204	–	.293
Tab Thickness	A1	.020	–	.055
Mounting Hole Center	Q	.100	–	.120
Mounting Hole Diameter	φP	.139	–	.156
Lead Length	L	.482	–	.590
Base to Bottom of Lead	A2	.080	–	.115
Lead Thickness	c	.012	–	.025
Lead Width	b	.015	.027	.040

**Notes:**

- Dimensions D and E do not include mold flash or protrusions. Mold flash or protrusions shall not exceed .005" per side.
- Dimensioning and tolerancing per ASME Y14.5M.

BSC: Basic Dimension. Theoretically exact value shown without tolerances.

Microchip Technology Drawing C04-036B



## 8-Lead Plastic Dual Flat, No Lead Package (MF) – 6x5 mm Body [DFN-S]

**Note:** For the most current package drawings, please see the Microchip Packaging Specification located at <http://www.microchip.com/packaging>

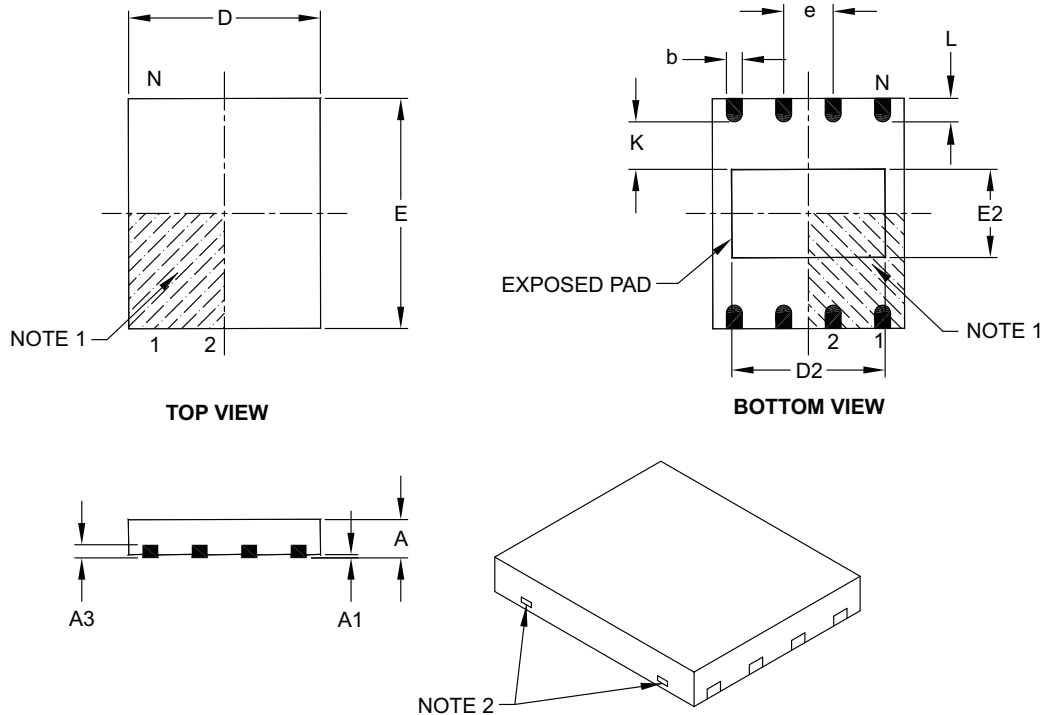

		Units	MILLIMETERS		
Dimension Limits			MIN	NOM	MAX
Number of Pins	N		8		
Pitch	e		1.27 BSC		
Overall Height	A	0.80	0.85	1.00	
Standoff	A1	0.00	0.01	0.05	
Contact Thickness	A3	0.20 REF			
Overall Length	D	5.00 BSC			
Overall Width	E	6.00 BSC			
Exposed Pad Length	D2	3.90	4.00	4.10	
Exposed Pad Width	E2	2.20	2.30	2.40	
Contact Width	b	0.35	0.40	0.48	
Contact Length	L	0.50	0.60	0.75	
Contact-to-Exposed Pad	K	0.20	–	–	

**Notes:**

- Pin 1 visual index feature may vary, but must be located within the hatched area.
- Package may have one or more exposed tie bars at ends.
- Package is saw singulated.
- Dimensioning and tolerancing per ASME Y14.5M.

BSC: Basic Dimension. Theoretically exact value shown without tolerances.

REF: Reference Dimension, usually without tolerance, for information purposes only.

Microchip Technology Drawing C04-122B

# MCP1406/07

8-Lead Plastic Dual Flat, No Lead Package (MF) - 6x5 mm Body [DFN-S]

**Note:** For the most current package drawings, please see the Microchip Packaging Specification located at <http://www.microchip.com/packaging>

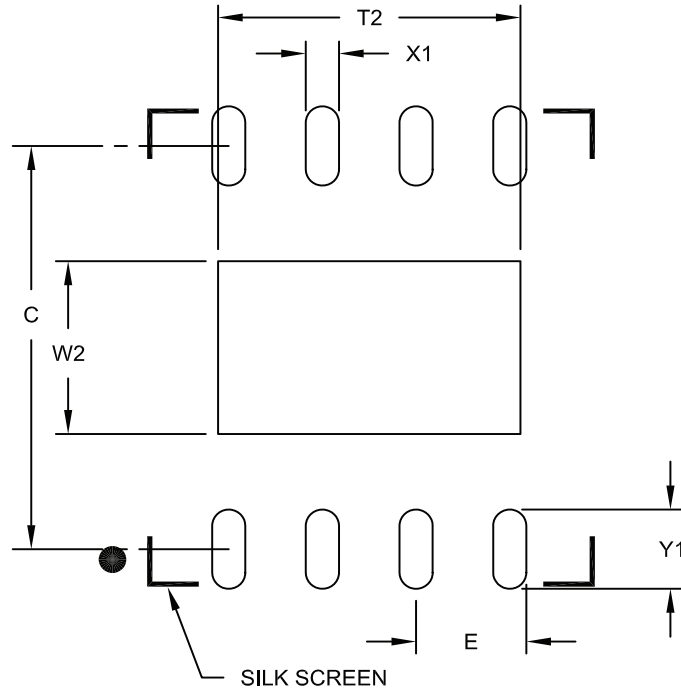

RECOMMENDED LAND PATTERN

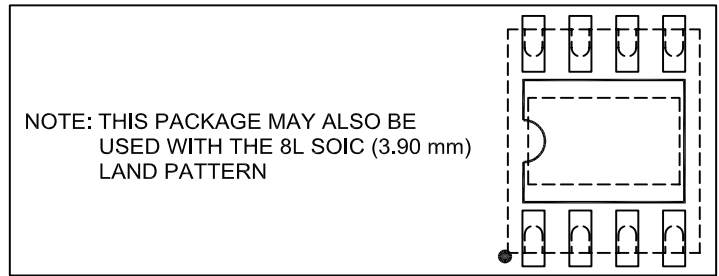

Dimension Limits	Units	MILLIMETERS		
		MIN	NOM	MAX
Contact Pitch	E	1.27 BSC		
Optional Center Pad Width	W2			2.40
Optional Center Pad Length	T2			4.10
Contact Pad Spacing	C		5.60	
Contact Pad Width (X8)	X1			0.45
Contact Pad Length (X8)	Y1			1.10

Notes:

1. Dimensioning and tolerancing per ASME Y14.5M

BSC: Basic Dimension. Theoretically exact value shown without tolerances.

Microchip Technology Drawing No. C04-2122A

## 8-Lead Plastic Dual In-Line (P) - 300 mil Body [PDIP]

**Note:** For the most current package drawings, please see the Microchip Packaging Specification located at <http://www.microchip.com/packaging>

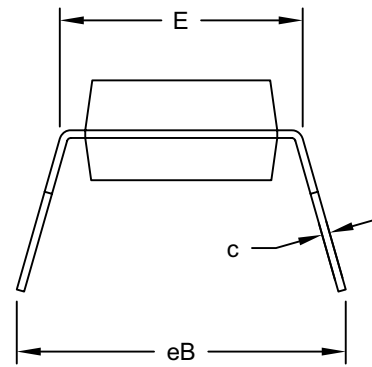
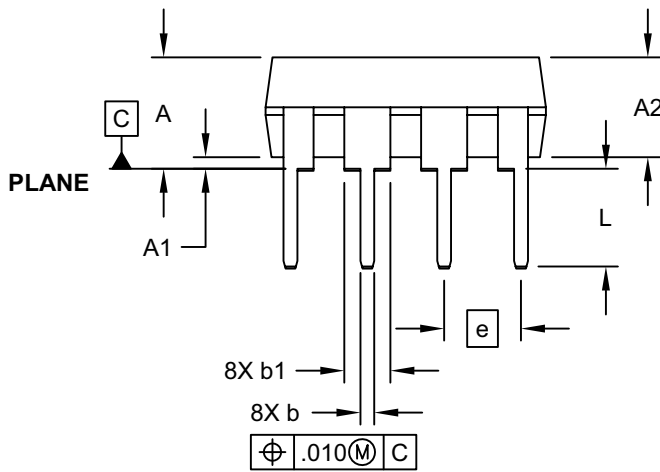
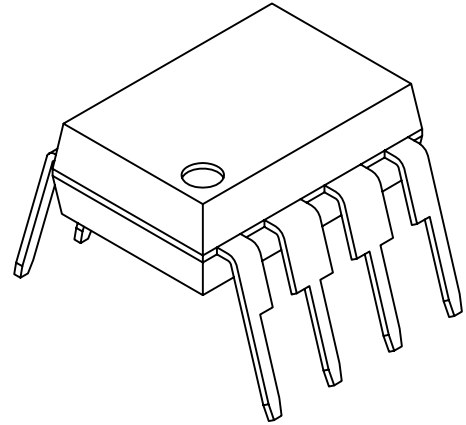
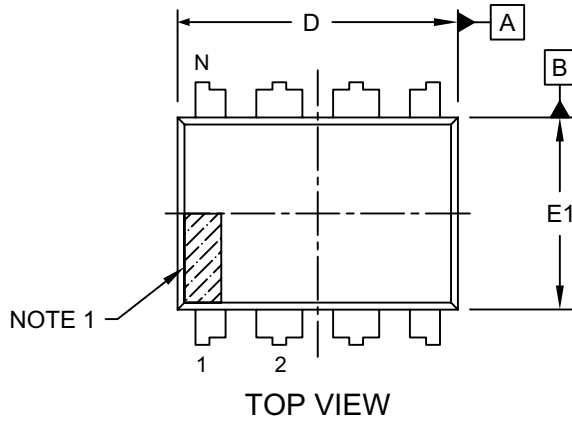

Microchip Technology Drawing No. C04-018D Sheet 1 of 2

# MCP1406/07

## 8-Lead Plastic Dual In-Line (P) - 300 mil Body [PDIP]

**Note:** For the most current package drawings, please see the Microchip Packaging Specification located at <http://www.microchip.com/packaging>

### ALTERNATE LEAD DESIGN (VENDOR DEPENDENT)

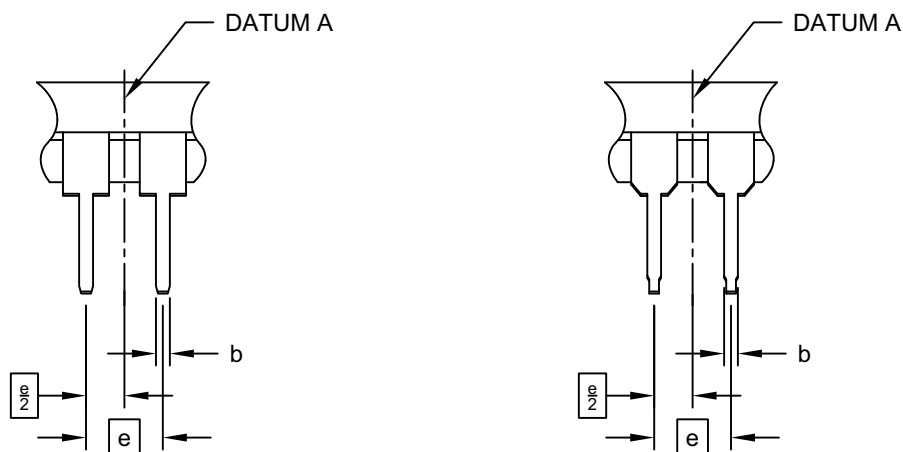

		Units	INCHES		
Dimension Limits			MIN	NOM	MAX
Number of Pins	N		8		
Pitch	e		.100 BSC		
Top to Seating Plane	A	-	-	.210	
Molded Package Thickness	A2	.115	.130	.195	
Base to Seating Plane	A1	.015	-	-	
Shoulder to Shoulder Width	E	.290	.310	.325	
Molded Package Width	E1	.240	.250	.280	
Overall Length	D	.348	.365	.400	
Tip to Seating Plane	L	.115	.130	.150	
Lead Thickness	c	.008	.010	.015	
Upper Lead Width	b1	.040	.060	.070	
Lower Lead Width	b	.014	.018	.022	
Overall Row Spacing	§	eB	-	-	.430

**Notes:**

1. Pin 1 visual index feature may vary, but must be located within the hatched area.
2. § Significant Characteristic
3. Dimensions D and E1 do not include mold flash or protrusions. Mold flash or protrusions shall not exceed .010" per side.
4. Dimensioning and tolerancing per ASME Y14.5M

BSC: Basic Dimension. Theoretically exact value shown without tolerances.

Microchip Technology Drawing No. C04-018D Sheet 2 of 2

## 8-Lead Plastic Small Outline (SN) - Narrow, 3.90 mm Body [SOIC]

**Note:** For the most current package drawings, please see the Microchip Packaging Specification located at <http://www.microchip.com/packaging>

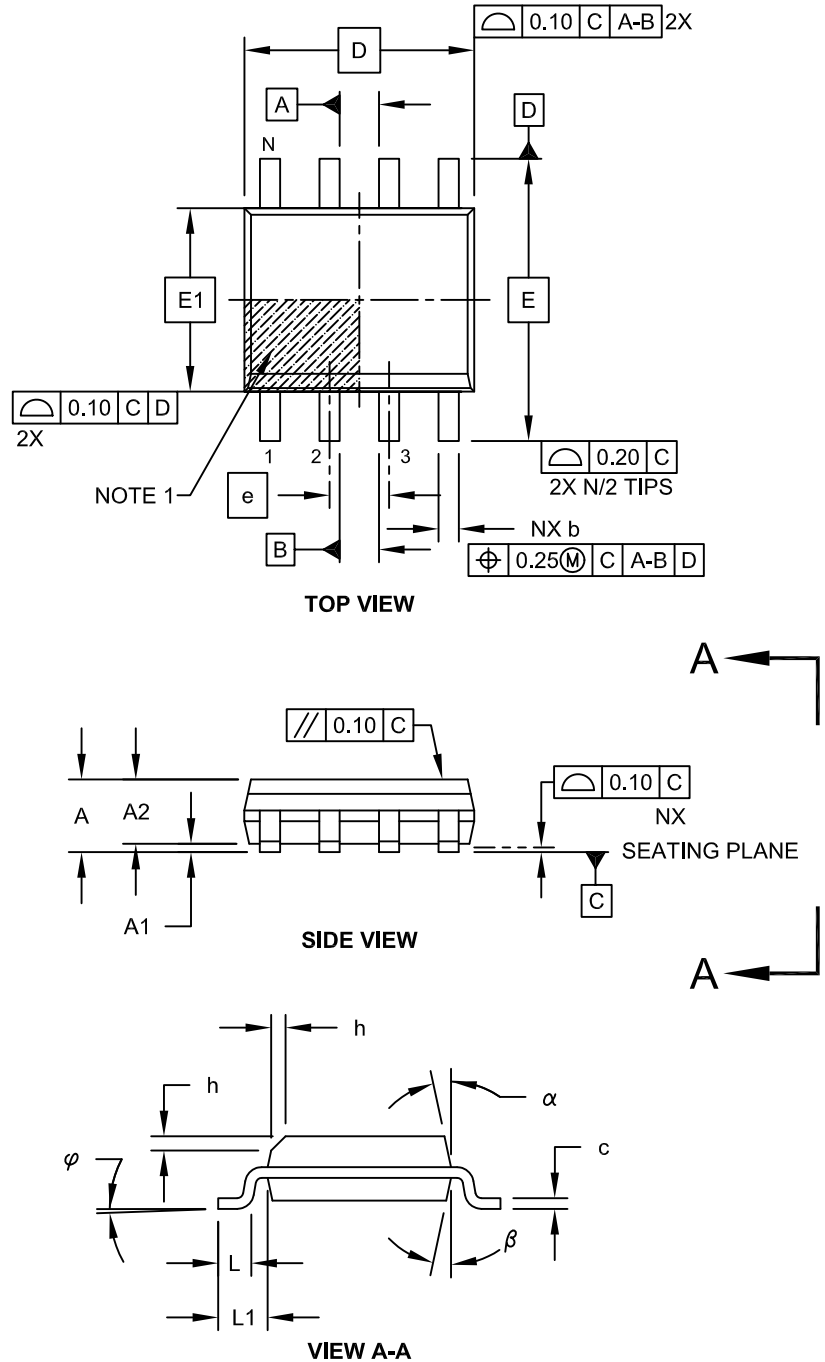

# MCP1406/07

## 8-Lead Plastic Small Outline (SN) - Narrow, 3.90 mm Body [SOIC]

**Note:** For the most current package drawings, please see the Microchip Packaging Specification located at <http://www.microchip.com/packageing>

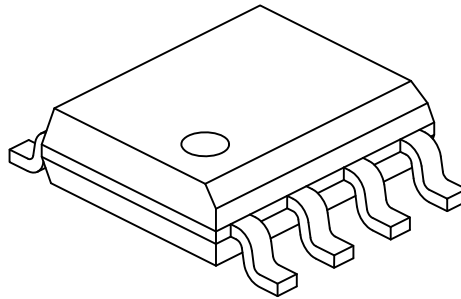

Dimension Limits	Units	MILLIMETERS		
		MIN	NOM	MAX
Number of Pins	N	8		
Pitch	e	1.27 BSC		
Overall Height	A	-	-	1.75
Molded Package Thickness	A2	1.25	-	-
Standoff §	A1	0.10	-	0.25
Overall Width	E	6.00 BSC		
Molded Package Width	E1	3.90 BSC		
Overall Length	D	4.90 BSC		
Chamfer (Optional)	h	0.25	-	0.50
Foot Length	L	0.40	-	1.27
Footprint	L1	1.04 REF		
Foot Angle	φ	0°	-	8°
Lead Thickness	c	0.17	-	0.25
Lead Width	b	0.31	-	0.51
Mold Draft Angle Top	α	5°	-	15°
Mold Draft Angle Bottom	β	5°	-	15°

**Notes:**

1. Pin 1 visual index feature may vary, but must be located within the hatched area.
2. § Significant Characteristic
3. Dimensions D and E1 do not include mold flash or protrusions. Mold flash or protrusions shall not exceed 0.15mm per side.
4. Dimensioning and tolerancing per ASME Y14.5M

BSC: Basic Dimension. Theoretically exact value shown without tolerances.

REF: Reference Dimension, usually without tolerance, for information purposes only.

Microchip Technology Drawing No. C04-057C Sheet 2 of 2

## 8-Lead Plastic Small Outline (SN) – Narrow, 3.90 mm Body [SOIC]

**Note:** For the most current package drawings, please see the Microchip Packaging Specification located at <http://www.microchip.com/packaging>

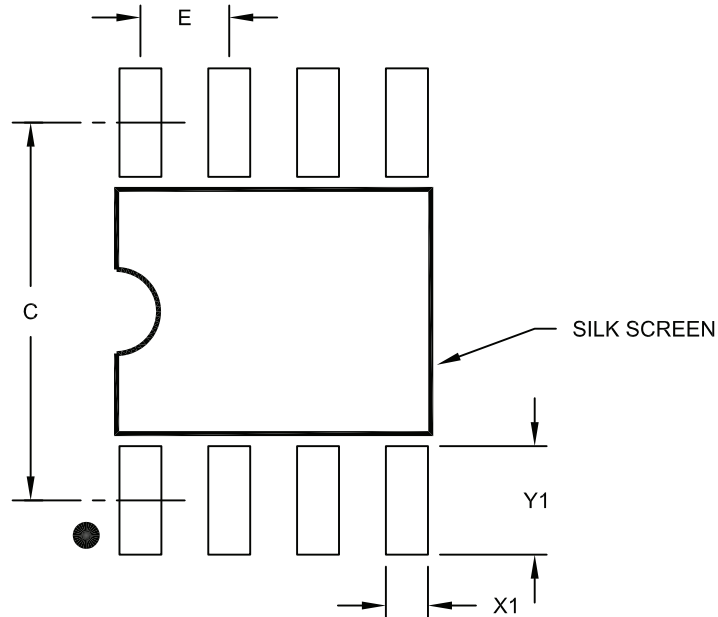

RECOMMENDED LAND PATTERN

Dimension Limits	Units	MILLIMETERS		
		MIN	NOM	MAX
Contact Pitch	E	1.27 BSC		
Contact Pad Spacing	C		5.40	
Contact Pad Width (X8)	X1			0.60
Contact Pad Length (X8)	Y1			1.55

**Notes:**

1. Dimensioning and tolerancing per ASME Y14.5M

BSC: Basic Dimension. Theoretically exact value shown without tolerances.

Microchip Technology Drawing No. C04-2057A

# MCP1406/07

---

NOTES:



## APPENDIX A: REVISION HISTORY

### Revision C (April 2016)

The following is the list of modifications:

- Updated the Package Thermal Resistances section of [Temperature Characteristics](#) table with the latest information.
- Updated [Figure 2-21](#) in [Section 2.0 “Typical Performance Curves”](#).

### Revision B (May 2012)

The following is the list of modifications:

Removed the information referring to the Electrostatic Discharge from the [General Description](#) section.

### Revision A (December 2006)

Original release of this document.

# MCP1406/07

---

NOTES:

## PRODUCT IDENTIFICATION SYSTEM

To order or obtain information, e.g., on pricing or delivery, refer to the factory or the listed sales office.

<u>PART NO.</u>	<u>X</u>	<u>XX</u>	<u>XXX</u>
Device	Temperature Range	Package	Tape & Reel
<p><b>Device:</b></p> <p>MCP1406: 6A High-Speed MOSFET Driver, Inverting</p> <p>MCP1406T: 6A High-Speed MOSFET Driver, Inverting, Tape and Reel</p> <p>MCP1407: 6A High-Speed MOSFET Driver, Non-Inverting</p> <p>MCP1407T: 6A High-Speed MOSFET Driver, Non-Inverting, Tape and Reel</p>			
<p><b>Temperature Range:</b> E = -40°C to +125°C</p>			
<p><b>Package: *</b></p> <p>AT = Plastic Transistor Outline, 5-Lead (TO-220)</p> <p>MF = Plastic Dual Flat - 6x5 mm Body, 8-Lead (DFN-S)</p> <p>P = Plastic Dual In-Line - 300 mil Body, 8-Lead (PDIP)</p> <p>SN = Plastic Small Outline - Narrow, 3.90 mm Body, 8-Lead (SOIC)</p> <p>* All package offerings are Pb Free (Lead Free)</p>			
<p><b>Examples:</b></p> <p>a) MCP1406-E/MF: 6A High-Speed MOSFET Driver, Inverting, 8LD DFN Package</p> <p>b) MCP1406-E/AT: 6A High-Speed MOSFET Driver, Inverting, 5LD TO-220 Package</p> <p>c) MCP1406-E/SN: 6A High-Speed MOSFET Driver, Inverting, 8LD SOIC Package</p> <p>d) MCP1406-E/P: 6A High-Speed MOSFET Driver, Inverting, 8LD PDIP Package</p> <p>e) MCP1406T-E/MF: Tape and Reel, 6A High-Speed MOSFET Driver, Inverting, 8LD DFN Package</p> <p>f) MCP1406T-E/SN: Tape and Reel, 6A High-Speed MOSFET Driver, Inverting, 8LD SOIC Package</p> <p>a) MCP1407-E/MF: 6A High-Speed MOSFET Driver, Non-Inverting, 8LD DFN Package</p> <p>b) MCP1407-E/AT: 6A High-Speed MOSFET Driver, Non-Inverting, 5LD TO-220 Package</p> <p>c) MCP1407-E/SN: 6A High-Speed MOSFET Driver, Non-Inverting, 8LD SOIC Package</p> <p>d) MCP1407-E/P: 6A High-Speed MOSFET Driver, Non-Inverting, 8LD PDIP Package</p> <p>e) MCP1407T-E/MF: Tape and Reel, 6A High-Speed MOSFET Driver, Non-Inverting, 8LD DFN Package</p> <p>f) MCP1407T-E/SN: Tape and Reel, 6A High-Speed MOSFET Driver, Non-Inverting, 8LD SOIC Package</p>			

# MCP1406/07

---

NOTES:

---

---

**Note the following details of the code protection feature on Microchip devices:**

- Microchip products meet the specification contained in their particular Microchip Data Sheet.
- Microchip believes that its family of products is one of the most secure families of its kind on the market today, when used in the intended manner and under normal conditions.
- There are dishonest and possibly illegal methods used to breach the code protection feature. All of these methods, to our knowledge, require using the Microchip products in a manner outside the operating specifications contained in Microchip's Data Sheets. Most likely, the person doing so is engaged in theft of intellectual property.
- Microchip is willing to work with the customer who is concerned about the integrity of their code.
- Neither Microchip nor any other semiconductor manufacturer can guarantee the security of their code. Code protection does not mean that we are guaranteeing the product as “unbreakable.”

Code protection is constantly evolving. We at Microchip are committed to continuously improving the code protection features of our products. Attempts to break Microchip's code protection feature may be a violation of the Digital Millennium Copyright Act. If such acts allow unauthorized access to your software or other copyrighted work, you may have a right to sue for relief under that Act.

---

Information contained in this publication regarding device applications and the like is provided only for your convenience and may be superseded by updates. It is your responsibility to ensure that your application meets with your specifications. MICROCHIP MAKES NO REPRESENTATIONS OR WARRANTIES OF ANY KIND WHETHER EXPRESS OR IMPLIED, WRITTEN OR ORAL, STATUTORY OR OTHERWISE, RELATED TO THE INFORMATION, INCLUDING BUT NOT LIMITED TO ITS CONDITION, QUALITY, PERFORMANCE, MERCHANTABILITY OR FITNESS FOR PURPOSE. Microchip disclaims all liability arising from this information and its use. Use of Microchip devices in life support and/or safety applications is entirely at the buyer's risk, and the buyer agrees to defend, indemnify and hold harmless Microchip from any and all damages, claims, suits, or expenses resulting from such use. No licenses are conveyed, implicitly or otherwise, under any Microchip intellectual property rights unless otherwise stated.

*Microchip received ISO/TS-16949:2009 certification for its worldwide headquarters, design and wafer fabrication facilities in Chandler and Tempe, Arizona; Gresham, Oregon and design centers in California and India. The Company's quality system processes and procedures are for its PIC® MCUs and dsPIC® DSCs, KEELOQ® code hopping devices, Serial EEPROMs, microperipherals, nonvolatile memory and analog products. In addition, Microchip's quality system for the design and manufacture of development systems is ISO 9001:2000 certified.*

**QUALITY MANAGEMENT SYSTEM  
CERTIFIED BY DNV  
= ISO/TS 16949 =**

### Trademarks

The Microchip name and logo, the Microchip logo, AnyRate, dsPIC, FlashFlex, flexPWR, Heldo, JukeBlox, KEELOQ, KEELOQ logo, Klear, LANCheck, LINK MD, MediaLB, MOST, MOST logo, MPLAB, OptoLyzer, PIC, PICSTART, PIC32 logo, RightTouch, SpyNIC, SST, SST Logo, SuperFlash and UNI/O are registered trademarks of Microchip Technology Incorporated in the U.S.A. and other countries.

ClockWorks, The Embedded Control Solutions Company, ETHERSYNCH, Hyper Speed Control, HyperLight Load, IntellIMOS, mTouch, Precision Edge, and QUIET-WIRE are registered trademarks of Microchip Technology Incorporated in the U.S.A.

Analog-for-the-Digital Age, Any Capacitor, AnyIn, AnyOut, BodyCom, chipKIT, chipKIT logo, CodeGuard, dsPICDEM, dsPICDEM.net, Dynamic Average Matching, DAM, ECAN, EtherGREEN, In-Circuit Serial Programming, ICSP, Inter-Chip Connectivity, JitterBlocker, KlearNet, KlearNet logo, MiWi, motorBench, MPASM, MPF, MPLAB Certified logo, MPLIB, MPLINK, MultiTRAK, NetDetach, Omniscient Code Generation, PICDEM, PICDEM.net, PICkit, PICtail, PureSilicon, RightTouch logo, REAL ICE, Ripple Blocker, Serial Quad I/O, SQL, SuperSwitcher, SuperSwitcher II, Total Endurance, TSHARC, USBCheck, VariSense, ViewSpan, WiperLock, Wireless DNA, and ZENA are trademarks of Microchip Technology Incorporated in the U.S.A. and other countries.

SQTP is a service mark of Microchip Technology Incorporated in the U.S.A.

Silicon Storage Technology is a registered trademark of Microchip Technology Inc. in other countries.

GestIC is a registered trademarks of Microchip Technology Germany II GmbH & Co. KG, a subsidiary of Microchip Technology Inc., in other countries.

All other trademarks mentioned herein are property of their respective companies.

© 2006-2016, Microchip Technology Incorporated, Printed in the U.S.A., All Rights Reserved.

ISBN: 978-1-5224-0450-7



# MICROCHIP

## Worldwide Sales and Service

### AMERICAS

**Corporate Office**  
2355 West Chandler Blvd.  
Chandler, AZ 85224-6199  
Tel: 480-792-7200  
Fax: 480-792-7277  
Technical Support:  
<http://www.microchip.com/support>  
Web Address:  
[www.microchip.com](http://www.microchip.com)

**Atlanta**  
Duluth, GA  
Tel: 678-957-9614  
Fax: 678-957-1455

**Austin, TX**  
Tel: 512-257-3370

**Boston**  
Westborough, MA  
Tel: 774-760-0087  
Fax: 774-760-0088

**Chicago**  
Itasca, IL  
Tel: 630-285-0071  
Fax: 630-285-0075

**Cleveland**  
Independence, OH  
Tel: 216-447-0464  
Fax: 216-447-0643

**Dallas**  
Addison, TX  
Tel: 972-818-7423  
Fax: 972-818-2924

**Detroit**  
Novi, MI  
Tel: 248-848-4000

**Houston, TX**  
Tel: 281-894-5983

**Indianapolis**  
Noblesville, IN  
Tel: 317-773-8323  
Fax: 317-773-5453

**Los Angeles**  
Mission Viejo, CA  
Tel: 949-462-9523  
Fax: 949-462-9608

**New York, NY**  
Tel: 631-435-6000

**San Jose, CA**  
Tel: 408-735-9110

**Canada - Toronto**  
Tel: 905-673-0699  
Fax: 905-673-6509

### ASIA/PACIFIC

**Asia Pacific Office**  
Suites 3707-14, 37th Floor  
Tower 6, The Gateway  
Harbour City, Kowloon

**Hong Kong**  
Tel: 852-2943-5100  
Fax: 852-2401-3431

**Australia - Sydney**  
Tel: 61-2-9868-6733  
Fax: 61-2-9868-6755

**China - Beijing**  
Tel: 86-10-8569-7000  
Fax: 86-10-8528-2104

**China - Chengdu**  
Tel: 86-28-8665-5511  
Fax: 86-28-8665-7889

**China - Chongqing**  
Tel: 86-23-8980-9588  
Fax: 86-23-8980-9500

**China - Dongguan**  
Tel: 86-769-8702-9880

**China - Hangzhou**  
Tel: 86-571-8792-8115  
Fax: 86-571-8792-8116

**China - Hong Kong SAR**  
Tel: 852-2943-5100  
Fax: 852-2401-3431

**China - Nanjing**  
Tel: 86-25-8473-2460  
Fax: 86-25-8473-2470

**China - Qingdao**  
Tel: 86-532-8502-7355  
Fax: 86-532-8502-7205

**China - Shanghai**  
Tel: 86-21-5407-5533  
Fax: 86-21-5407-5066

**China - Shenyang**  
Tel: 86-24-2334-2829  
Fax: 86-24-2334-2393

**China - Shenzhen**  
Tel: 86-755-8864-2200  
Fax: 86-755-8203-1760

**China - Wuhan**  
Tel: 86-27-5980-5300  
Fax: 86-27-5980-5118

**China - Xian**  
Tel: 86-29-8833-7252  
Fax: 86-29-8833-7256

### ASIA/PACIFIC

**China - Xiamen**  
Tel: 86-592-2388138  
Fax: 86-592-2388130

**China - Zhuhai**  
Tel: 86-756-3210040  
Fax: 86-756-3210049

**India - Bangalore**  
Tel: 91-80-3090-4444  
Fax: 91-80-3090-4123

**India - New Delhi**  
Tel: 91-11-4160-8631  
Fax: 91-11-4160-8632

**India - Pune**  
Tel: 91-20-3019-1500

**Japan - Osaka**  
Tel: 81-6-6152-7160  
Fax: 81-6-6152-9310

**Japan - Tokyo**  
Tel: 81-3-6880-3770  
Fax: 81-3-6880-3771

**Korea - Daegu**  
Tel: 82-53-744-4301  
Fax: 82-53-744-4302

**Korea - Seoul**  
Tel: 82-2-554-7200  
Fax: 82-2-558-5932 or  
82-2-558-5934

**Malaysia - Kuala Lumpur**  
Tel: 60-3-6201-9857  
Fax: 60-3-6201-9859

**Malaysia - Penang**  
Tel: 60-4-227-8870  
Fax: 60-4-227-4068

**Philippines - Manila**  
Tel: 63-2-634-9065  
Fax: 63-2-634-9069

**Singapore**  
Tel: 65-6334-8870  
Fax: 65-6334-8850

**Taiwan - Hsin Chu**  
Tel: 886-3-5778-366  
Fax: 886-3-5770-955

**Taiwan - Kaohsiung**  
Tel: 886-7-213-7828

**Taiwan - Taipei**  
Tel: 886-2-2508-8600  
Fax: 886-2-2508-0102

**Thailand - Bangkok**  
Tel: 66-2-694-1351  
Fax: 66-2-694-1350

### EUROPE

**Austria - Wels**  
Tel: 43-7242-2244-39  
Fax: 43-7242-2244-393

**Denmark - Copenhagen**  
Tel: 45-4450-2828  
Fax: 45-4485-2829

**France - Paris**  
Tel: 33-1-69-53-63-20  
Fax: 33-1-69-30-90-79

**Germany - Dusseldorf**  
Tel: 49-2129-3766400

**Germany - Karlsruhe**  
Tel: 49-721-625370

**Germany - Munich**  
Tel: 49-89-627-144-0  
Fax: 49-89-627-144-44

**Italy - Milan**  
Tel: 39-0331-742611  
Fax: 39-0331-466781

**Italy - Venice**  
Tel: 39-049-7625286

**Netherlands - Drunen**  
Tel: 31-416-690399  
Fax: 31-416-690340

**Poland - Warsaw**  
Tel: 48-22-3325737

**Spain - Madrid**  
Tel: 34-91-708-08-90  
Fax: 34-91-708-08-91

**Sweden - Stockholm**  
Tel: 46-8-5090-4654

**UK - Wokingham**  
Tel: 44-118-921-5800  
Fax: 44-118-921-5820

07/14/15