

Tiny 1.5A, High-Speed Power MOSFET Driver

Features

- High Peak Output Current: 1.5A (typical)
- Wide Input Supply Voltage Operating Range:
 - 4.5V to 18V
- Low Shoot-Through/Cross-Conduction Current in Output Stage
- High Capacitive Load Drive Capability:
 - 470 pF in 13 ns (typical)
 - 1000 pF in 20 ns (typical)
- Short Delay Times: 41 ns (t_{D1}), 48 ns (t_{D2}) (typical)
- Low Supply Current:
 - With Logic '1' Input - 0.65 mA (typical)
 - With Logic '0' Input - 0.1 mA (typical)
- Latch-Up Protected: Will Withstand 500 mA Reverse Current
- Logic Input Will Withstand Negative Swing Up to 5V
- Space-saving 5L SOT-23 Package

Applications

- Switch Mode Power Supplies
- Pulse Transformer Drive
- Line Drivers
- Level Translator
- Motor and Solenoid Drive

General Description

MCP1415/16 devices are high-speed MOSFET drivers that are capable of providing 1.5A of peak current. The inverting or non-inverting single channel output is directly controlled from either TTL or CMOS (3V to 18V) logic. These devices also feature low shoot-through current, matched rise and fall time, and short propagation delays which make them ideal for high switching frequency applications.

MCP1415/16 devices operate from a single 4.5V to 18V power supply and can easily charge and discharge 1000 pF gate capacitance in under 20 ns (typical). They provide low enough impedances in both the on and off states to ensure that the intended state of the MOSFET will not be affected, even by large transients.

These devices are highly latch-up resistant under any condition within their power and voltage ratings. They are not subject to damage when noise spiking (up to 5V, of either polarity) occurs on the ground pin. They can accept, without damage or logic upset, up to 500 mA of reverse current being forced back into their outputs. All terminals are fully protected against Electrostatic Discharge (ESD) up to 2.0 kV (HBM) and 400V (MM).

Package Types:

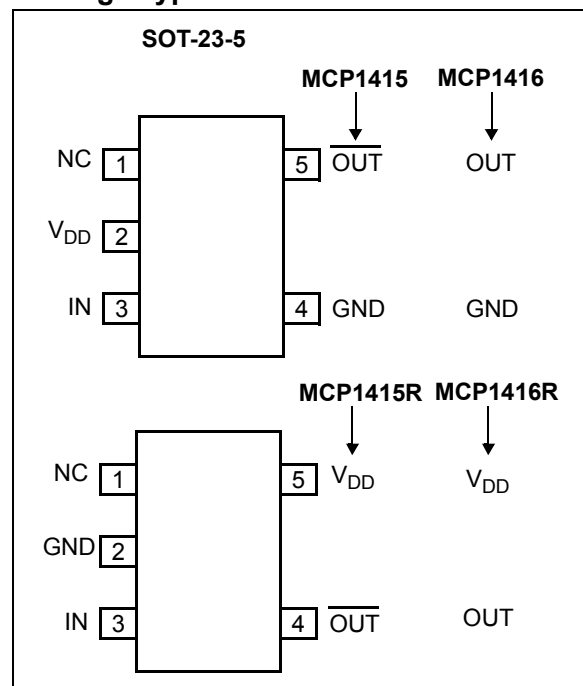

MCP1415/16

Functional Block Diagram

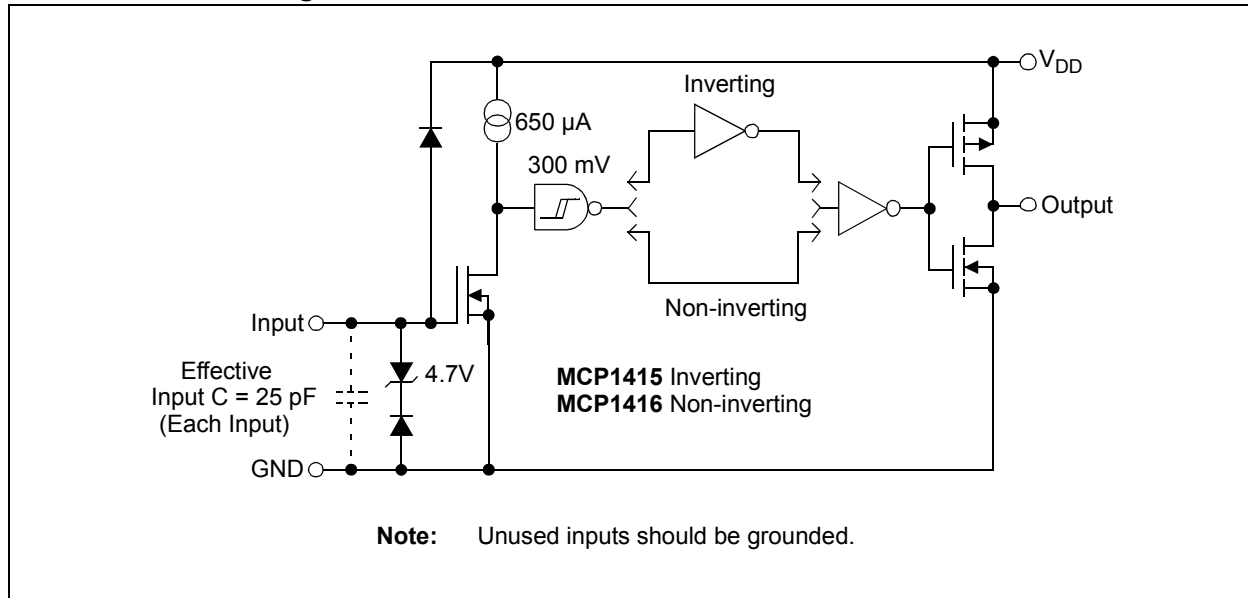

1.0 ELECTRICAL CHARACTERISTICS

Absolute Maximum Ratings †

V _{DD} , Supply Voltage.....	+20V
V _{IN} , Input Voltage.....	(V _{DD} + 0.3V) to (GND - 5V)
Package Power Dissipation (T _A = 50°C)	
5L SOT23.....	0.39W
ESD Protection on all Pins.....	2.0 kV (HBM)
.....	400V (MM)

† **Notice:** Stresses above those listed under "Maximum Ratings" may cause permanent damage to the device. This is a stress rating only and functional operation of the device at those or any other conditions above those indicated in the operational sections of this specification is not intended. Exposure to maximum rating conditions for extended periods may affect device reliability.

DC CHARACTERISTICS

Electrical Specifications: Unless otherwise noted, T _A = +25°C, with 4.5V ≤ V _{DD} ≤ 18V						
Parameters	Sym	Min	Typ	Max	Units	Conditions
Input						
Logic '1' High Input Voltage	V _{IH}	2.4	1.9	—	V	
Logic '0' Low Input Voltage	V _{IL}	—	1.6	0.8	V	
Input Current	I _{IN}	-1	—	+1	μA	0V ≤ V _{IN} ≤ V _{DD}
Input Voltage	V _{IN}	-5	—	V _{DD} +0.3	V	
Output						
High Output Voltage	V _{OH}	V _{DD} - 0.025	—	—	V	DC Test
Low Output Voltage	V _{OL}	—	—	0.025	V	DC Test
Output Resistance, High	R _{OH}	—	6	7.5	Ω	I _{OUT} = 10 mA, V _{DD} = 18V (Note 2)
Output Resistance, Low	R _{OL}	—	4	5.5	Ω	I _{OUT} = 10 mA, V _{DD} = 18V (Note 2)
Peak Output Current	I _{PK}	—	1.5	—	A	V _{DD} = 18V (Note 2)
Latch-Up Protection Withstand Reverse Current	I _{REV}	0.5	—	—	A	Duty cycle ≤ 2%, t ≤ 300 μs (Note 2)
Switching Time (Note 1)						
Rise Time	t _R	—	20	25	ns	Figure 4-1, Figure 4-2 C _L = 1000 pF (Note 2)
Fall Time	t _F	—	20	25	ns	Figure 4-1, Figure 4-2 C _L = 1000 pF (Note 2)
Delay Time	t _{D1}	—	41	50	ns	Figure 4-1, Figure 4-2 (Note 2)
Delay Time	t _{D2}	—	48	55	ns	Figure 4-1, Figure 4-2 (Note 2)
Power Supply						
Supply Voltage	V _{DD}	4.5	—	18	V	
Power Supply Current	I _S	—	0.65	1.1	mA	V _{IN} = 3V
	I _S	—	0.1	0.15	mA	V _{IN} = 0V

Note 1: Switching times ensured by design.

Note 2: Tested during characterization, not production tested.

MCP1415/16

DC CHARACTERISTICS (OVER OPERATING TEMPERATURE RANGE)

Electrical Specifications: Unless otherwise indicated, over operating range with $4.5V \leq V_{DD} \leq 18V$.						
Parameters	Sym	Min	Typ	Max	Units	Conditions
Input						
Logic '1', High Input Voltage	V_{IH}	2.4	—	—	V	
Logic '0', Low Input Voltage	V_{IL}	—	—	0.8	V	
Input Current	I_{IN}	-10	—	+10	μA	$0V \leq V_{IN} \leq V_{DD}$
Input Voltage	V_{IN}	-5	—	$V_{DD}+0.3$	V	
Output						
High Output Voltage	V_{OH}	$V_{DD} - 0.025$	—	—	V	DC Test
Low Output Voltage	V_{OL}	—	—	0.025	V	DC Test
Output Resistance, High	R_{OH}	—	8.5	9.5	Ω	$I_{OUT} = 10 \text{ mA}$, $V_{DD} = 18V$ (Note 2)
Output Resistance, Low	R_{OL}	—	6	7	Ω	$I_{OUT} = 10 \text{ mA}$, $V_{DD} = 18V$ (Note 2)
Switching Time (Note 1)						
Rise Time	t_R	—	30	40	ns	Figure 4-1, Figure 4-2 $C_L = 1000 \text{ pF}$ (Note 2)
Fall Time	t_F	—	30	40	ns	Figure 4-1, Figure 4-2 $C_L = 1000 \text{ pF}$ (Note 2)
Delay Time	t_{D1}	—	45	55	ns	Figure 4-1, Figure 4-2 (Note 2)
Delay Time	t_{D2}	—	50	60		Figure 4-1, Figure 4-2 (Note 2)
Power Supply						
Supply Voltage	V_{DD}	4.5	—	18	V	
Power Supply Current	I_S	—	0.75	1.5	mA	$V_{IN} = 3.0V$
	I_S	—	0.15	0.25	mA	$V_{IN} = 0V$

Note 1: Switching times ensured by design.
Note 2: Tested during characterization, not production tested.

TEMPERATURE CHARACTERISTICS

Electrical Specifications: Unless otherwise noted, all parameters apply with $4.5V \leq V_{DD} \leq 18V$						
Parameter	Sym	Min	Typ	Max	Units	Comments
Temperature Ranges						
Specified Temperature Range	T_A	-40	—	+125	$^{\circ}C$	
Maximum Junction Temperature	T_J	—	—	+150	$^{\circ}C$	
Storage Temperature Range	T_A	-65	—	+150	$^{\circ}C$	
Package Thermal Resistances						
Thermal Resistance, 5LD SOT23	θ_{JA}	—	256	—	$^{\circ}C/W$	

2.0 TYPICAL PERFORMANCE CURVES

Note: The graphs and tables provided following this note are a statistical summary based on a limited number of samples and are provided for informational purposes only. The performance characteristics listed herein are not tested or guaranteed. In some graphs or tables, the data presented may be outside the specified operating range (e.g., outside specified power supply range) and therefore outside the warranted range.

Note: Unless otherwise indicated, $T_A = +25^\circ\text{C}$ with $4.5\text{V} \leq V_{DD} \leq 18\text{V}$.

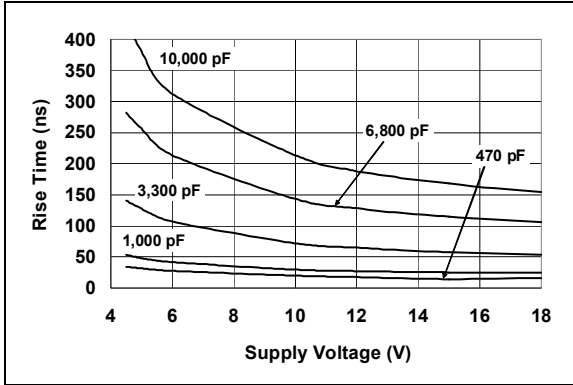

FIGURE 2-1: Rise Time vs. Supply Voltage.

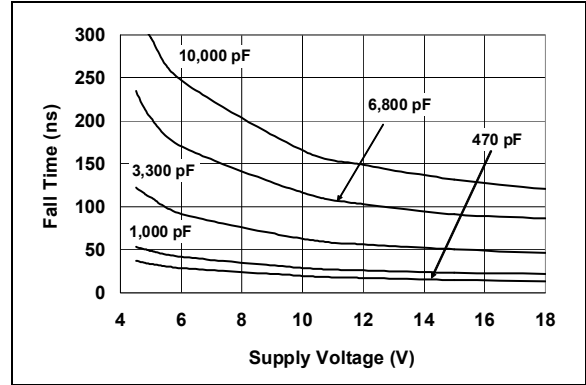

FIGURE 2-4: Fall Time vs. Supply Voltage.

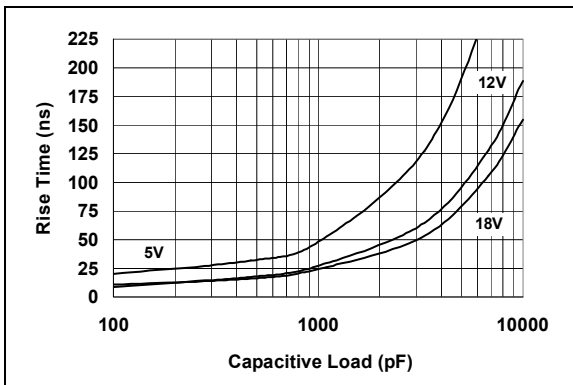

FIGURE 2-2: Rise Time vs. Capacitive Load.

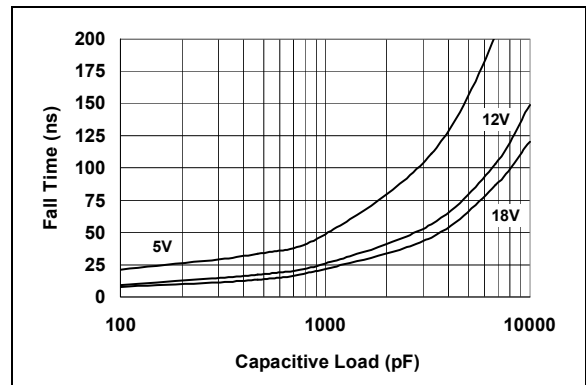

FIGURE 2-5: Fall Time vs. Capacitive Load.

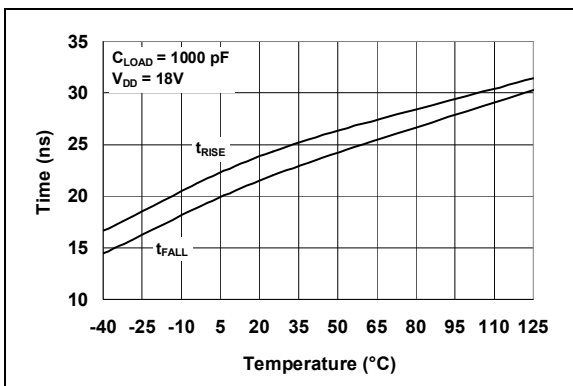

FIGURE 2-3: Rise and Fall Times vs. Temperature.

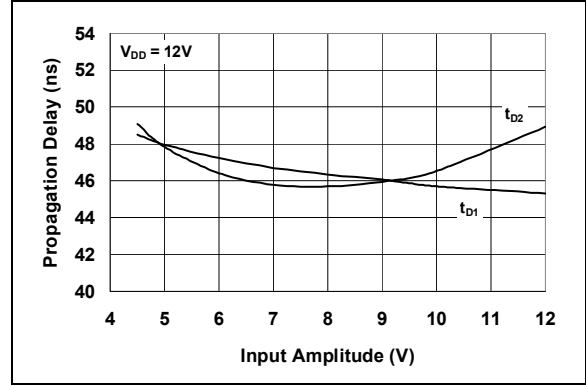

FIGURE 2-6: Propagation Delay Time vs. Input Amplitude.

MCP1415/16

Note: Unless otherwise indicated, $T_A = +25^\circ\text{C}$ with $4.5\text{V} \leq V_{DD} \leq 18\text{V}$.

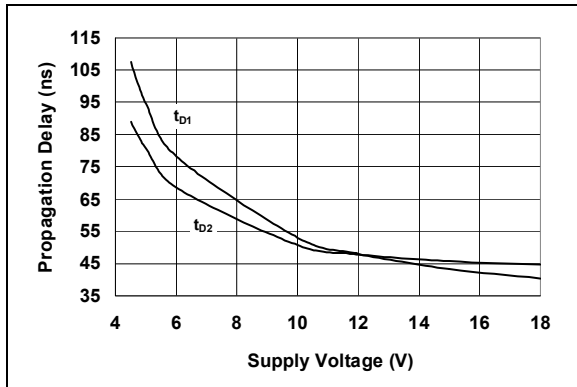

FIGURE 2-7: Propagation Delay Time vs. Supply Voltage.

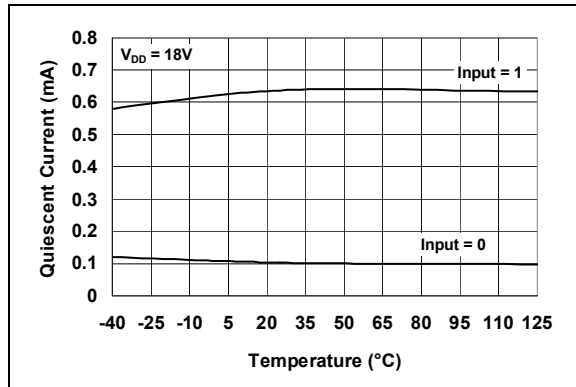

FIGURE 2-10: Quiescent Current vs. Temperature.

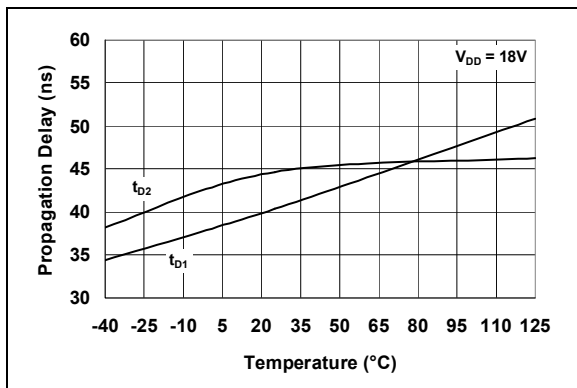

FIGURE 2-8: Propagation Delay Time vs. Temperature.

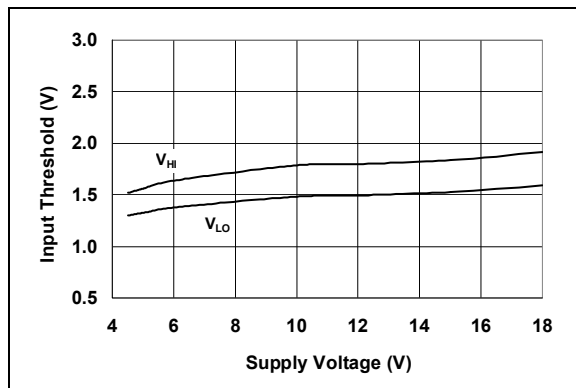

FIGURE 2-11: Input Threshold vs. Supply Voltage.

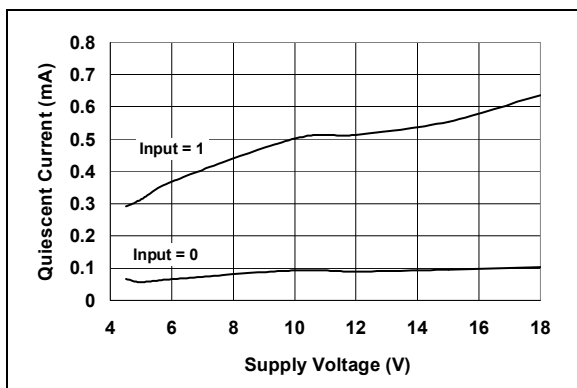

FIGURE 2-9: Quiescent Current vs. Supply Voltage.

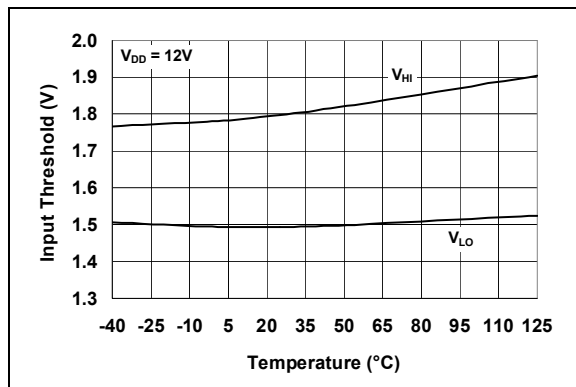

FIGURE 2-12: Input Threshold vs. Temperature.

Note: Unless otherwise indicated, $T_A = +25^\circ\text{C}$ with $4.5\text{V} \leq V_{DD} \leq 18\text{V}$.

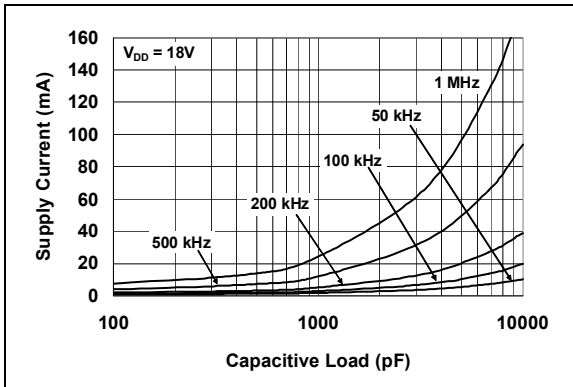

FIGURE 2-13: Supply Current vs. Capacitive Load.

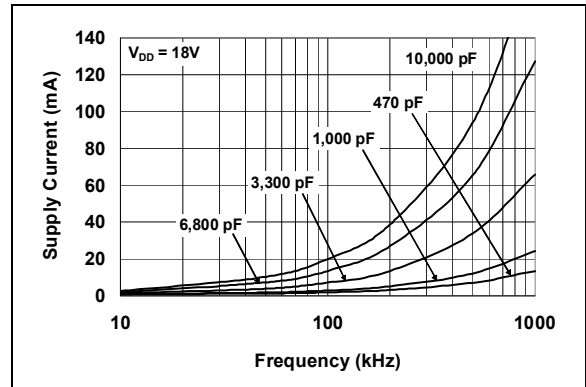

FIGURE 2-16: Supply Current vs. Frequency.

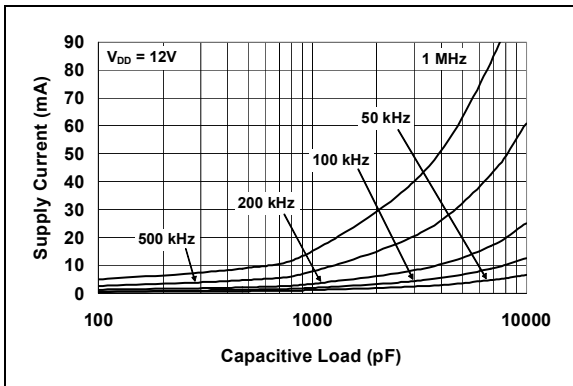

FIGURE 2-14: Supply Current vs. Capacitive Load.

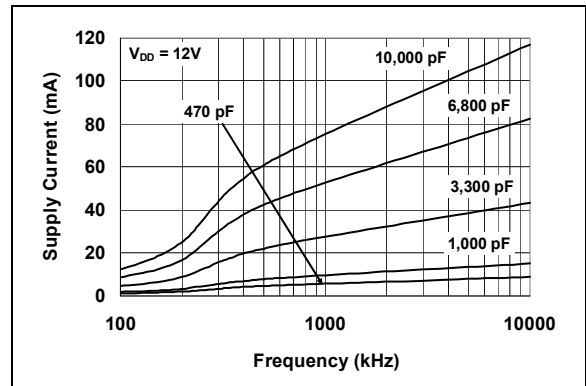

FIGURE 2-17: Supply Current vs. Frequency.

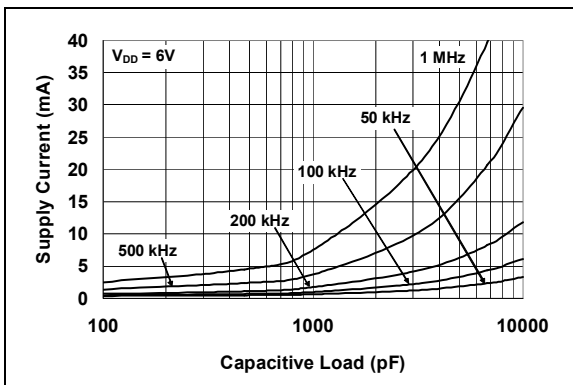

FIGURE 2-15: Supply Current vs. Capacitive Load.

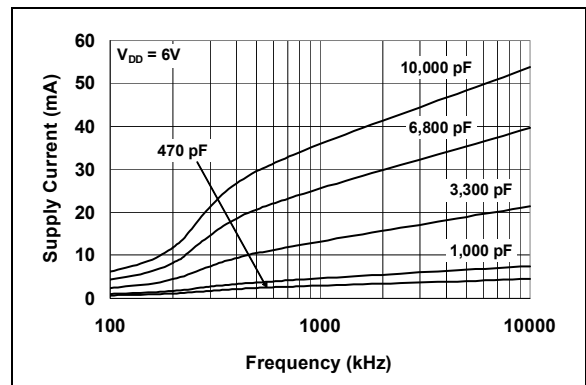

FIGURE 2-18: Supply Current vs. Frequency.

MCP1415/16

Note: Unless otherwise indicated, $T_A = +25^\circ\text{C}$ with $4.5\text{V} \leq V_{DD} \leq 18\text{V}$.

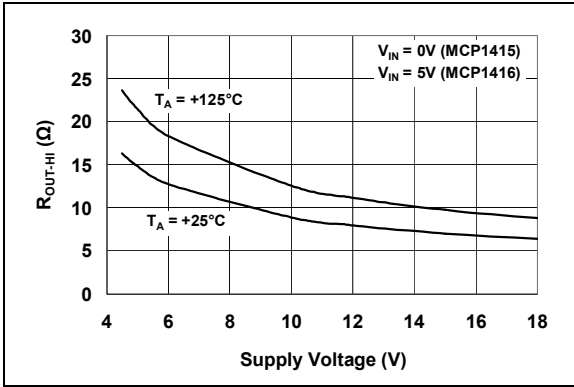

FIGURE 2-19: Output Resistance (Output High) vs. Supply Voltage.

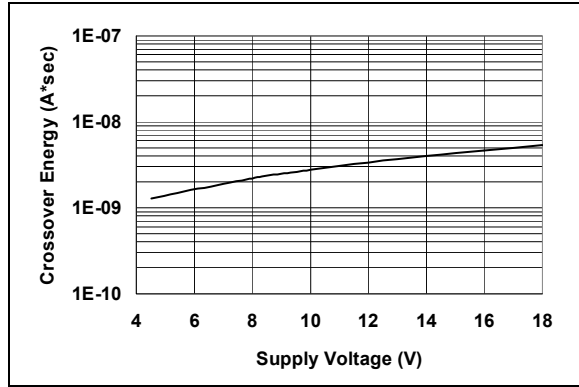

FIGURE 2-21: Crossover Energy vs. Supply Voltage.

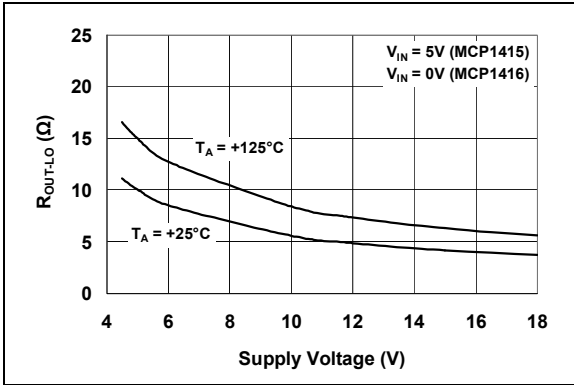

FIGURE 2-20: Output Resistance (Output Low) vs. Supply Voltage.

3.0 PIN DESCRIPTIONS

The descriptions of the pins are listed in [Table 3-1](#).

TABLE 3-1: PIN FUNCTION TABLE

SOT-23-5 Pin	Symbol		Description
	MCP1415/6	MCP1415R/6R	
1	NC	NC	No Connection
2	V _{DD}	GND	Supply Input
3	IN	IN	Control Input
4	GND	OUT	Ground
5	OUT	V _{DD}	Output

3.1 Supply Input (V_{DD})

V_{DD} is the bias supply input for the MOSFET driver and has a voltage range of 4.5V to 18V. This input must be decoupled to ground with a local capacitor. This bypass capacitor provides a localized low impedance path for the peak currents that are to be provided to the load.

3.2 Control Input (IN)

The MOSFET driver input is a high impedance, TTL/CMOS compatible input. The input also has hysteresis between the high and low input levels, allowing them to be driven from a slow rising and falling signals, and to provide noise immunity.

3.3 Ground (GND)

Ground is the device return pin. The ground pin should have a low impedance connection to the bias supply source return. High peak currents will flow out the ground pin when the capacitive load is being discharged.

3.4 Output (OUT)

The output is a CMOS push-pull output that is capable of sourcing and sinking 1.5A of peak current (V_{DD} = 18V). The low output impedance ensures the gate of the external MOSFET will stay in the intended state even during large transients. This output also has a reverse current latch-up rating of 500 mA.

MCP1415/16

NOTES:

4.0 APPLICATION INFORMATION

4.1 General Information

MOSFET drivers are high-speed, high current devices which are intended to source/sink high peak currents to charge/discharge the gate capacitance of external MOSFETs or IGBTs. In high frequency switching power supplies, the PWM controller may not have the drive capability to directly drive the power MOSFET. A MOSFET driver like the MCP1415/16 family can be used to provide additional source/sink current capability.

4.2 MOSFET Driver Timing

The ability of a MOSFET driver to transition from a fully-off state to a fully-on state are characterized by the drivers rise time (t_R), fall time (t_F), and propagation delays (t_{D1} and t_{D2}). The MCP1415/16 family of drivers can typically charge and discharge a 1000 pF load capacitance in 20 ns along with a typical turn on (t_{D1}) propagation delay of 41 ns. [Figure 4-1](#) and [Figure 4-2](#) show the test circuit and timing waveform used to verify the MCP1415/16 timing.

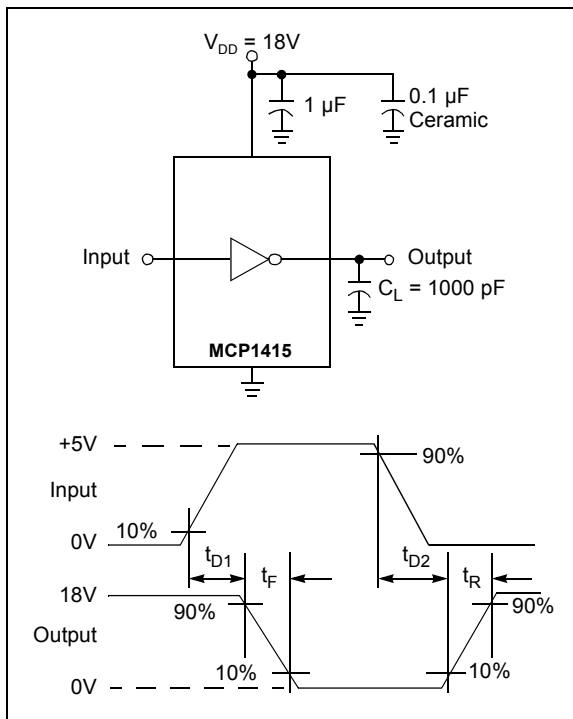

FIGURE 4-1: Inverting Driver Timing Waveform.

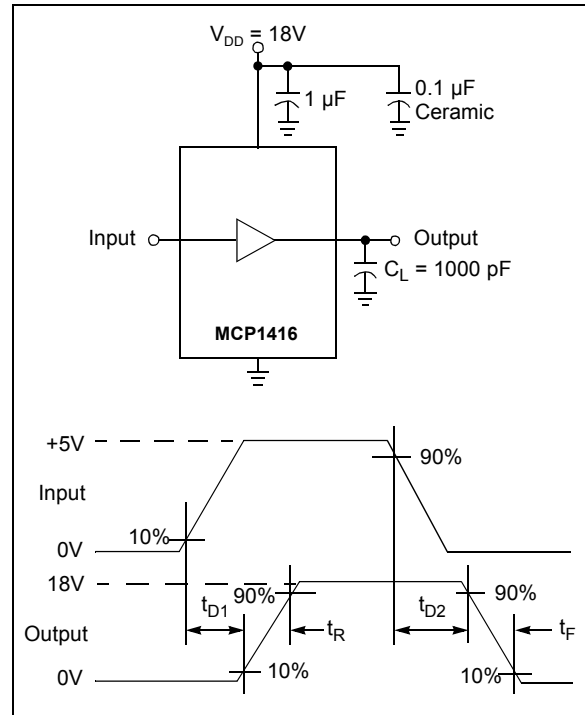

FIGURE 4-2: Non-Inverting Driver Timing Waveform.

4.3 Decoupling Capacitors

Careful layout and decoupling capacitors are required when using power MOSFET drivers. Large current are required to charge and discharge capacitive loads quickly. For example, approximately 720 mA are needed to charge a 1000 pF load with 18V in 25 ns.

To operate the MOSFET driver over a wide frequency range with low supply impedance, a ceramic and low ESR film capacitor is recommended to be placed in parallel between the driver V_{DD} and GND. A 1.0 μF low ESR film capacitor and a 0.1 μF ceramic capacitor placed between pins 2 and 4 is required for reliable operation. These capacitors should be placed close to the driver to minimize circuit board parasitics and provide a local source for the required current.

MCP1415/16

4.4 Power Dissipation

The total internal power dissipation in a MOSFET driver is the summation of three separate power dissipation elements.

EQUATION 4-1:

$$P_T = P_L + P_Q + P_{CC}$$

Where:

P_T	=	Total power dissipation
P_L	=	Load power dissipation
P_Q	=	Quiescent power dissipation
P_{CC}	=	Operating power dissipation

4.4.1 CAPACITIVE LOAD DISSIPATION

The power dissipation caused by a capacitive load is a direct function of the frequency, total capacitive load, and supply voltage. The power lost in the MOSFET driver for a complete charging and discharging cycle of a MOSFET is shown in Equation 4-2.

EQUATION 4-2:

$$P_L = f \times C_T \times V_{DD}^2$$

Where:

f	=	Switching frequency
C_T	=	Total load capacitance
V_{DD}	=	MOSFET driver supply voltage

4.4.2 QUIESCENT POWER DISSIPATION

The power dissipation associated with the quiescent current draw depends upon the state of the input pin. The MCP1415/16 devices have a quiescent current draw when the input is high of 0.65 mA (typical) and 0.1 mA (typical) when the input is low. The quiescent power dissipation is shown in Equation 4-3.

EQUATION 4-3:

$$P_Q = (I_{QH} \times D + I_{QL} \times (1 - D)) \times V_{DD}$$

Where:

I_{QH}	=	Quiescent current in the high state
D	=	Duty cycle
I_{QL}	=	Quiescent current in the low state
V_{DD}	=	MOSFET driver supply voltage

4.4.3 OPERATING POWER DISSIPATION

The operating power dissipation occurs each time the MOSFET driver output transitions because for a very short period of time both MOSFETs in the output stage are on simultaneously. This cross-conduction current leads to a power dissipation describe in Equation 4-4.

EQUATION 4-4:

$$P_{CC} = CC \times f \times V_{DD}$$

Where:

CC	=	Cross-conduction constant (A*sec)
f	=	Switching frequency
V_{DD}	=	MOSFET driver supply voltage

4.5 PCB Layout Considerations

Proper PCB layout is important in high current, fast switching circuits to provide proper device operation and robustness of design. Improper component placement may cause errant switching, excessive voltage ringing, or circuit latch-up. PCB trace loop area and inductance must be minimized. This is accomplished by placing the MOSFET driver directly at the load and placing the bypass capacitor directly at the MOSFET driver (Figure 4-3). Locating ground planes or ground return traces directly beneath the driver output signal also reduces trace inductance. A ground plane will also help as a radiated noise shield as well as providing some heat sinking for power dissipated within the device (Figure 4-4).

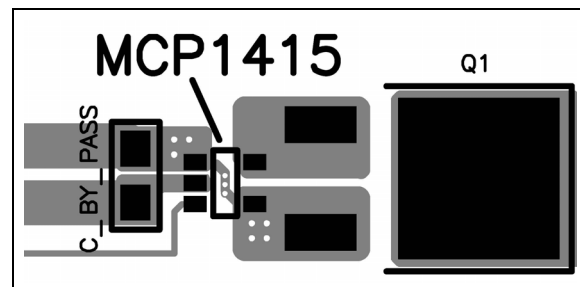

FIGURE 4-3: Recommended PCB Layout (TOP).

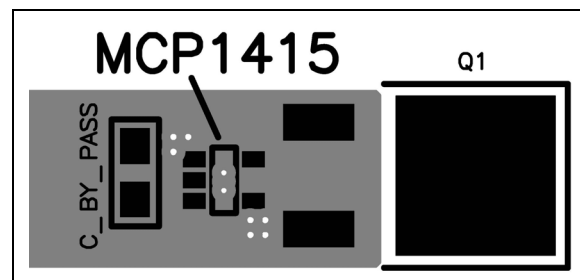
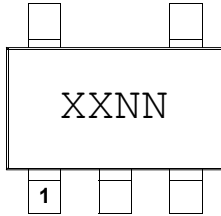

FIGURE 4-4: Recommended PCB Layout (BOTTOM).

5.0 PACKAGING INFORMATION

5.1 Package Marking Information

5-Lead SOT-23



Standard Markings for SOT-23	
Part Number	Code
MCP1415T-E/OT	FYNN
MCP1416T-E/OT	FZNN
MCP1415RT-E/OT	F7NN
MCP1416RT-E/OT	F8NN

Example:

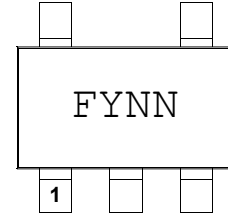

Legend:	XX...X	Customer-specific information
	Y	Year code (last digit of calendar year)
	YY	Year code (last 2 digits of calendar year)
	WW	Week code (week of January 1 is week '01')
	NNN	Alphanumeric traceability code
	(e3)	Pb-free JEDEC designator for Matte Tin (Sn)
	*	This package is Pb-free. The Pb-free JEDEC designator (e3) can be found on the outer packaging for this package.

Note: In the event the full Microchip part number cannot be marked on one line, it will be carried over to the next line, thus limiting the number of available characters for customer-specific information.

MCP1415/16

5-Lead Plastic Small Outline Transistor (OT) [SOT-23]

Note: For the most current package drawings, please see the Microchip Packaging Specification located at <http://www.microchip.com/packaging>

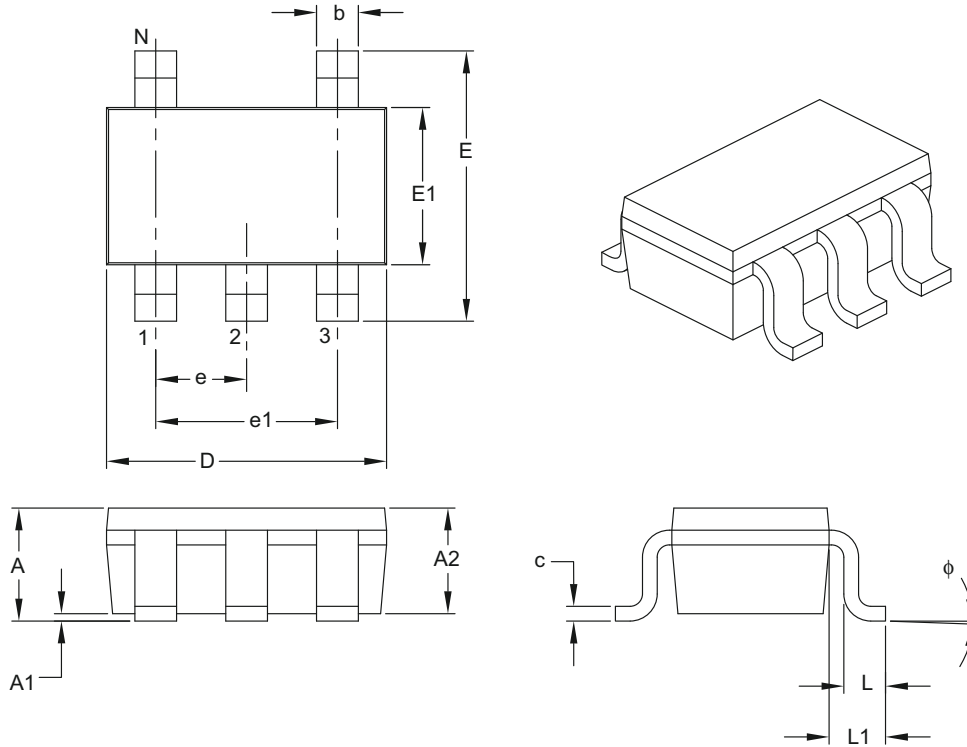

Dimension Limits	Units	MILLIMETERS		
		MIN	NOM	MAX
Number of Pins	N	5		
Lead Pitch	e	0.95 BSC		
Outside Lead Pitch	e1	1.90 BSC		
Overall Height	A	0.90	–	1.45
Molded Package Thickness	A2	0.89	–	1.30
Standoff	A1	0.00	–	0.15
Overall Width	E	2.20	–	3.20
Molded Package Width	E1	1.30	–	1.80
Overall Length	D	2.70	–	3.10
Foot Length	L	0.10	–	0.60
Footprint	L1	0.35	–	0.80
Foot Angle	ϕ	0°	–	30°
Lead Thickness	c	0.08	–	0.26
Lead Width	b	0.20	–	0.51

Notes:

- Dimensions D and E1 do not include mold flash or protrusions. Mold flash or protrusions shall not exceed 0.127 mm per side.
- Dimensioning and tolerancing per ASME Y14.5M.

BSC: Basic Dimension. Theoretically exact value shown without tolerances.

Microchip Technology Drawing C04-091B

5-Lead Plastic Small Outline Transistor (OT) [SOT-23]

Note: For the most current package drawings, please see the Microchip Packaging Specification located at <http://www.microchip.com/packaging>

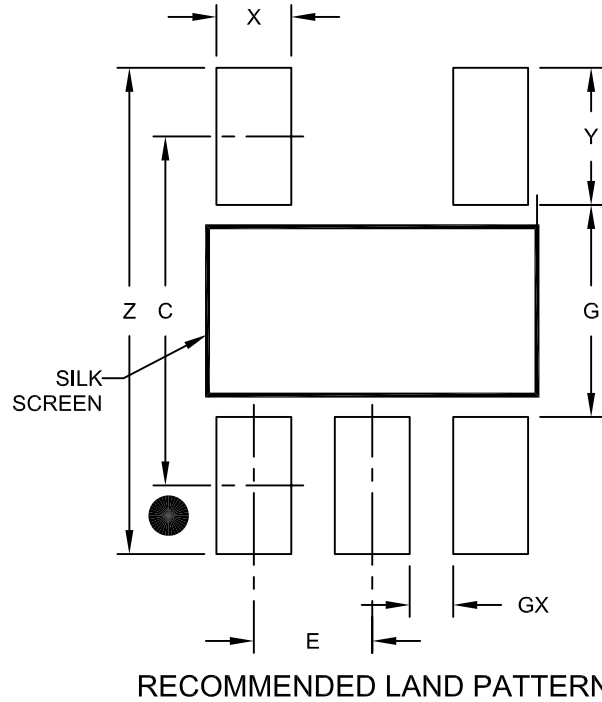

Dimension Limits	Units	MILLIMETERS		
		MIN	NOM	MAX
Contact Pitch	E	0.95 BSC		
Contact Pad Spacing	C		2.80	
Contact Pad Width (X5)	X			0.60
Contact Pad Length (X5)	Y			1.10
Distance Between Pads	G	1.70		
Distance Between Pads	GX	0.35		
Overall Width	Z			3.90

Notes:

1. Dimensioning and tolerancing per ASME Y14.5M

BSC: Basic Dimension. Theoretically exact value shown without tolerances.

Microchip Technology Drawing No. C04-2091A

MCP1415/16

NOTES:

APPENDIX A: REVISION HISTORY

Revision D (December 2010)

The following is the list of modifications:

1. Updated [Figure 2-19](#) and [Figure 2-20](#).
2. Updated the package outline drawings.

Revision C (December 2008)

The following is the list of modifications:

1. Added the MCP1415R/16R devices throughout document.

Revision B (June 2008)

The following is the list of modifications:

1. DC Characteristics table, Switching Time, Rise Time: changed from 13 to 20.
2. DC Characteristics table, Switching Time, Fall Time: changed from 13 to 20.
3. DC Characteristics (Over Operating Temperature Range) table, Switching Time, Rise Time: changed maximum from 35 to 40.
4. DC Characteristics (Over Operating Temperature Range) table, Switching Time, Rise Time: changed typical from 25 to 30.
5. DC Characteristics (Over Operating Temperature Range) table, Switching Time, Fall Time: changed maximum from 35 to 40.
6. DC Characteristics (Over Operating Temperature Range) table, Switching Time, Fall Time: changed typical from 25 to 30.

Revision A (June 2008)

- Original Release of this Document.

MCP1415/16

NOTES:

PRODUCT IDENTIFICATION SYSTEM

To order or obtain information, e.g., on pricing or delivery, refer to the factory or the listed sales office.

<u>PART NO.</u>	<u>-X</u>	<u>/XX</u>
Device	Temperature Range	Package
Device: MCP1415T: 1.5A MOSFET Driver, Inverting (Tape and Reel) MCP1415RT: 1.5A MOSFET Driver, Inverting (Tape and Reel) MCP1416T: 1.5A MOSFET Driver, Non-Inverting (Tape and Reel) MCP1416RT: 1.5A MOSFET Driver, Non-Inverting (Tape and Reel)	Temperature Range: E = -40°C to +125°C	Package: * OT = Plastic Thin Small Outline Transistor (OT), 5-Lead * All package offerings are Pb Free (Lead Free)
Examples: a) MCP1415T-E/OT: 1.5A Inverting, MOSFET Driver 5LD SOT-23 Package b) MCP1415RT-E/OT: 1.5A Inverting, MOSFET Driver 5LD SOT-23 Package a) MCP1416T-E/OT: 1.5A Non-Inverting, MOSFET Driver 5LD SOT-23 Package b) MCP1416RT-E/OT: 1.5A Non-Inverting, MOSFET Driver 5LD SOT-23 Package		

MCP1415/16

NOTES:

Note the following details of the code protection feature on Microchip devices:

- Microchip products meet the specification contained in their particular Microchip Data Sheet.
- Microchip believes that its family of products is one of the most secure families of its kind on the market today, when used in the intended manner and under normal conditions.
- There are dishonest and possibly illegal methods used to breach the code protection feature. All of these methods, to our knowledge, require using the Microchip products in a manner outside the operating specifications contained in Microchip's Data Sheets. Most likely, the person doing so is engaged in theft of intellectual property.
- Microchip is willing to work with the customer who is concerned about the integrity of their code.
- Neither Microchip nor any other semiconductor manufacturer can guarantee the security of their code. Code protection does not mean that we are guaranteeing the product as "unbreakable."

Code protection is constantly evolving. We at Microchip are committed to continuously improving the code protection features of our products. Attempts to break Microchip's code protection feature may be a violation of the Digital Millennium Copyright Act. If such acts allow unauthorized access to your software or other copyrighted work, you may have a right to sue for relief under that Act.

Information contained in this publication regarding device applications and the like is provided only for your convenience and may be superseded by updates. It is your responsibility to ensure that your application meets with your specifications. MICROCHIP MAKES NO REPRESENTATIONS OR WARRANTIES OF ANY KIND WHETHER EXPRESS OR IMPLIED, WRITTEN OR ORAL, STATUTORY OR OTHERWISE, RELATED TO THE INFORMATION, INCLUDING BUT NOT LIMITED TO ITS CONDITION, QUALITY, PERFORMANCE, MERCHANTABILITY OR FITNESS FOR PURPOSE. Microchip disclaims all liability arising from this information and its use. Use of Microchip devices in life support and/or safety applications is entirely at the buyer's risk, and the buyer agrees to defend, indemnify and hold harmless Microchip from any and all damages, claims, suits, or expenses resulting from such use. No licenses are conveyed, implicitly or otherwise, under any Microchip intellectual property rights.

Trademarks

The Microchip name and logo, the Microchip logo, dsPIC, KEELOQ, KEELOQ logo, MPLAB, PIC, PICmicro, PICSTART, PIC³² logo, rPIC and UNI/O are registered trademarks of Microchip Technology Incorporated in the U.S.A. and other countries.

FilterLab, Hampshire, HI-TECH C, Linear Active Thermistor, MXDEV, MXLAB, SEEVAL and The Embedded Control Solutions Company are registered trademarks of Microchip Technology Incorporated in the U.S.A.

Analog-for-the-Digital Age, Application Maestro, CodeGuard, dsPICDEM, dsPICDEM.net, dsPICworks, dsSPEAK, ECAN, ECONOMONITOR, FanSense, HI-TIDE, In-Circuit Serial Programming, ICSP, Mindi, MiWi, MPASM, MPLAB Certified logo, MPLIB, MPLINK, mTouch, Omniscient Code Generation, PICC, PICC-18, PICDEM, PICDEM.net, PICkit, PICTail, REAL ICE, rLAB, Select Mode, Total Endurance, TSHARC, UniWinDriver, WiperLock and ZENA are trademarks of Microchip Technology Incorporated in the U.S.A. and other countries.

SQTP is a service mark of Microchip Technology Incorporated in the U.S.A.

All other trademarks mentioned herein are property of their respective companies.

© 2010, Microchip Technology Incorporated, Printed in the U.S.A., All Rights Reserved.

 Printed on recycled paper.

ISBN: 978-1-60932-667-8

Microchip received ISO/TS-16949:2002 certification for its worldwide headquarters, design and wafer fabrication facilities in Chandler and Tempe, Arizona; Gresham, Oregon and design centers in California and India. The Company's quality system processes and procedures are for its PIC® MCUs and dsPIC® DSCs, KEELOQ® code hopping devices, Serial EEPROMs, microperipherals, nonvolatile memory and analog products. In addition, Microchip's quality system for the design and manufacture of development systems is ISO 9001:2000 certified.

**QUALITY MANAGEMENT SYSTEM
CERTIFIED BY DNV
== ISO/TS 16949:2002 ==**



MICROCHIP

Worldwide Sales and Service

AMERICAS

Corporate Office
2355 West Chandler Blvd.
Chandler, AZ 85224-6199
Tel: 480-792-7200
Fax: 480-792-7277
Technical Support:
<http://support.microchip.com>
Web Address:
www.microchip.com

Atlanta
Duluth, GA
Tel: 678-957-9614
Fax: 678-957-1455

Boston
Westborough, MA
Tel: 774-760-0087
Fax: 774-760-0088

Chicago
Itasca, IL
Tel: 630-285-0071
Fax: 630-285-0075

Cleveland
Independence, OH
Tel: 216-447-0464
Fax: 216-447-0643

Dallas
Addison, TX
Tel: 972-818-7423
Fax: 972-818-2924

Detroit
Farmington Hills, MI
Tel: 248-538-2250
Fax: 248-538-2260

Kokomo
Kokomo, IN
Tel: 765-864-8360
Fax: 765-864-8387

Los Angeles
Mission Viejo, CA
Tel: 949-462-9523
Fax: 949-462-9608

Santa Clara
Santa Clara, CA
Tel: 408-961-6444
Fax: 408-961-6445

Toronto
Mississauga, Ontario,
Canada
Tel: 905-673-0699
Fax: 905-673-6509

ASIA/PACIFIC

Asia Pacific Office
Suites 3707-14, 37th Floor
Tower 6, The Gateway
Harbour City, Kowloon
Hong Kong
Tel: 852-2401-1200
Fax: 852-2401-3431

Australia - Sydney
Tel: 61-2-9868-6733
Fax: 61-2-9868-6755

China - Beijing
Tel: 86-10-8528-2100
Fax: 86-10-8528-2104

China - Chengdu
Tel: 86-28-8665-5511
Fax: 86-28-8665-7889

China - Chongqing
Tel: 86-23-8980-9588
Fax: 86-23-8980-9500

China - Hong Kong SAR
Tel: 852-2401-1200
Fax: 852-2401-3431

China - Nanjing
Tel: 86-25-8473-2460
Fax: 86-25-8473-2470

China - Qingdao
Tel: 86-532-8502-7355
Fax: 86-532-8502-7205

China - Shanghai
Tel: 86-21-5407-5533
Fax: 86-21-5407-5066

China - Shenyang
Tel: 86-24-2334-2829
Fax: 86-24-2334-2393

China - Shenzhen
Tel: 86-755-8203-2660
Fax: 86-755-8203-1760

China - Wuhan
Tel: 86-27-5980-5300
Fax: 86-27-5980-5118

China - Xian
Tel: 86-29-8833-7252
Fax: 86-29-8833-7256

China - Xiamen
Tel: 86-592-2388138
Fax: 86-592-2388130

China - Zhuhai
Tel: 86-756-3210040
Fax: 86-756-3210049

ASIA/PACIFIC

India - Bangalore
Tel: 91-80-3090-4444
Fax: 91-80-3090-4123

India - New Delhi
Tel: 91-11-4160-8631
Fax: 91-11-4160-8632

India - Pune
Tel: 91-20-2566-1512
Fax: 91-20-2566-1513

Japan - Yokohama
Tel: 81-45-471- 6166
Fax: 81-45-471-6122

Korea - Daegu
Tel: 82-53-744-4301
Fax: 82-53-744-4302

Korea - Seoul
Tel: 82-2-554-7200
Fax: 82-2-558-5932 or
82-2-558-5934

Malaysia - Kuala Lumpur
Tel: 60-3-6201-9857
Fax: 60-3-6201-9859

Malaysia - Penang
Tel: 60-4-227-8870
Fax: 60-4-227-4068

Philippines - Manila
Tel: 63-2-634-9065
Fax: 63-2-634-9069

Singapore
Tel: 65-6334-8870
Fax: 65-6334-8850

Taiwan - Hsin Chu
Tel: 886-3-6578-300
Fax: 886-3-6578-370

Taiwan - Kaohsiung
Tel: 886-7-213-7830
Fax: 886-7-330-9305

Taiwan - Taipei
Tel: 886-2-2500-6610
Fax: 886-2-2508-0102

Thailand - Bangkok
Tel: 66-2-694-1351
Fax: 66-2-694-1350

EUROPE

Austria - Wels
Tel: 43-7242-2244-39
Fax: 43-7242-2244-393

Denmark - Copenhagen
Tel: 45-4450-2828
Fax: 45-4485-2829

France - Paris
Tel: 33-1-69-53-63-20
Fax: 33-1-69-30-90-79

Germany - Munich
Tel: 49-89-627-144-0
Fax: 49-89-627-144-44

Italy - Milan
Tel: 39-0331-742611
Fax: 39-0331-466781

Netherlands - Drunen
Tel: 31-416-690399
Fax: 31-416-690340

Spain - Madrid
Tel: 34-91-708-08-90
Fax: 34-91-708-08-91

UK - Wokingham
Tel: 44-118-921-5869
Fax: 44-118-921-5820

08/04/10