

## 2 $\mu$ A Low-Dropout Positive Voltage Regulator

### Features

- 2.0  $\mu$ A Typical Quiescent Current
- Input Operating Voltage Range up to 10.0V
- Low-Dropout Voltage (LDO):
  - 120 mV (typ) @ 100 mA
  - 380 mV (typ) @ 200 mA
- High Output Current: 250 mA ( $V_{OUT} = 5.0V$ )
- High-Accuracy Output Voltage:  $\pm 2\%$  (max)
- Low Temperature Drift:  $\pm 100$  ppm/ $^{\circ}C$  (typ.)
- Excellent Line Regulation: 0.2%/V (typ.)
- Package Options: 3-Pin SOT-23A, 3-Pin SOT-89, and 3-Pin TO-92
- Short Circuit Protection
- Standard Output Voltage Options:
  - 1.8V, 2.5V, 3.0V, 3.3V, 5.0V

### Applications

- Battery-Powered Devices
- Battery-Powered Alarm Circuits
- Smoke Detectors
- CO<sup>2</sup> Detectors
- Smart Battery Packs
- PDAs
- Low-Quiescent Current Voltage Reference
- Cameras and Portable Video Equipment
- Pagers and Cellular Phones
- Solar-Powered Instruments
- Consumer Products
- Microcontroller Power

### General Description

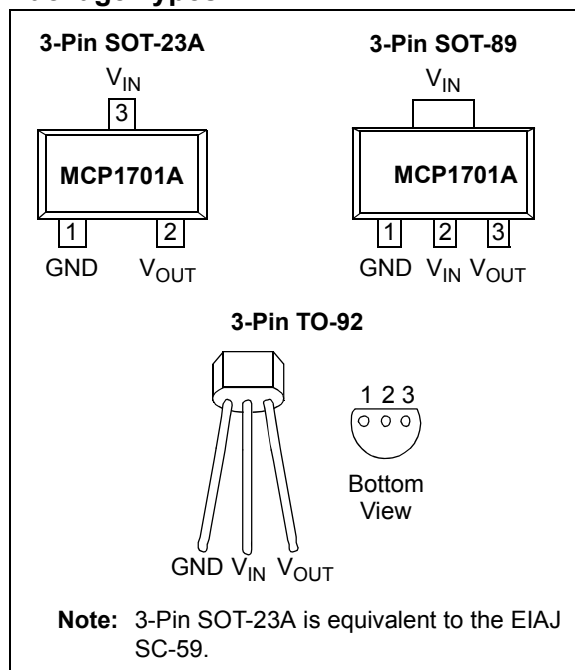
The MCP1701A is a family of CMOS low-dropout, positive voltage regulators that can deliver up to 250 mA of current while consuming only 2.0  $\mu$ A of quiescent current (typ.). The input operating range is specified up to 10V, making it ideal for lithium-ion (one or two cells), 9V alkaline and other two and three primary cell battery-powered applications.

The MCP1701A is capable of delivering 250 mA with an input-to-output voltage differential (dropout voltage) of 650 mV. The low-dropout voltage extends the battery operating lifetime. It also permits high currents in small packages when operated with minimum  $V_{IN} - V_{OUT}$  differentials. The MCP1701A offers improved startup and transient response.

The MCP1701A has a tight tolerance output voltage regulation of  $\pm 0.5\%$  (typ.) and very good line regulation at  $\pm 0.2\%$ . The LDO output is stable when using only 1  $\mu$ F of output capacitance of either tantalum or aluminum-electrolytic style capacitors. The MCP1701A LDO also incorporates short circuit protection to ensure maximum reliability.

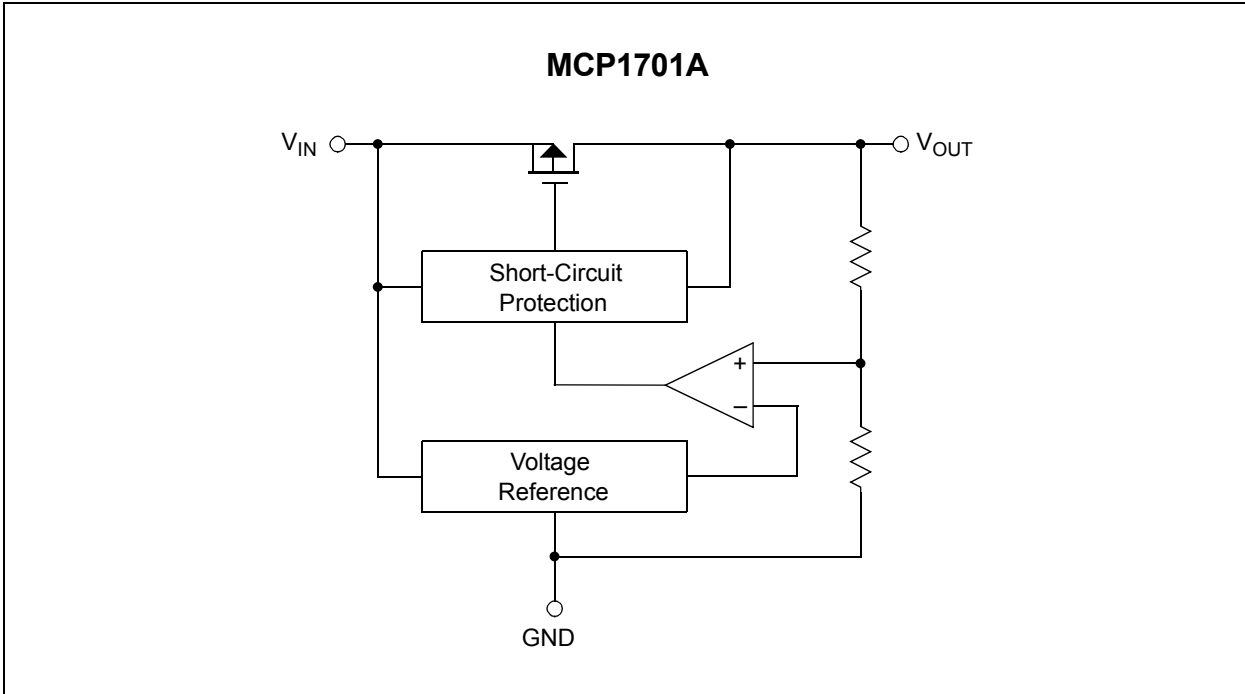
Package options include the 3-pin SOT-23A, 3-pin SOT-89 and 3-Pin TO-92.

### Package Types

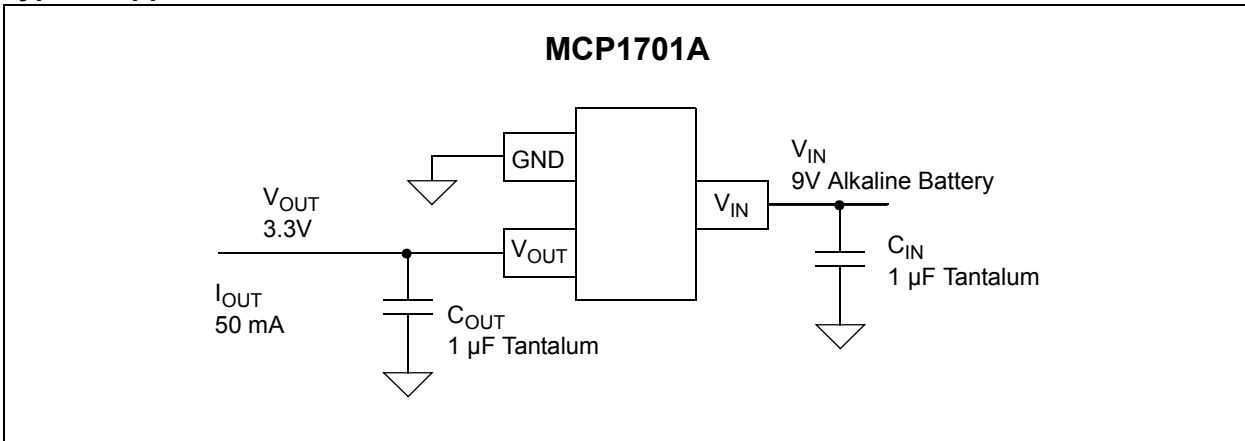


# MCP1701A

## Functional Block Diagram



## Typical Application Circuits



## 1.0 ELECTRICAL CHARACTERISTICS

### Absolute Maximum Ratings †

Input Voltage .....	+12V
Output Current (Continuous).....	$P_D / (V_{IN} - V_{OUT})$ mA
Output Current (peak) .....	500 mA
Output Voltage .....	(GND - 0.3V) to $(V_{IN} + 0.3V)$
Continuous Power Dissipation:	
3-Pin SOT-23A .....	150 mW
3-Pin SOT-89 .....	500 mW
3-Pin TO-92 .....	300 mW

† **Notice:** Stresses above those listed under “Absolute Maximum Ratings” may cause permanent damage to the device. These are stress ratings only and functional operation of the device at these or any other conditions above those indicated in the operation sections of the specifications is not implied. Exposure to Absolute Maximum Rating conditions for extended periods may affect device reliability.

### ELECTRICAL CHARACTERISTICS

Electrical Specifications: Unless otherwise specified, all limits are established for an ambient temperature of $T_A = +25^\circ\text{C}$ .						
Parameters	Sym	Min	Typ	Max	Units	Conditions
Output Voltage Regulation	$V_{OUT}$	$V_R - 2\%$	$V_R \pm 0.5\%$	$V_R + 2\%$	V	$I_{OUT} = 40 \text{ mA}$ (Note 1)
Maximum Output Current	$I_{OUTMAX}$	250 200 150 150 125 110	— — — — — —	— — — — — —	mA	$V_{OUT} = 5.0V$ ( $V_{IN} = V_R + 1.0V$ ) $V_{OUT} = 4.0V$ $V_{OUT} = 3.3V$ $V_{OUT} = 3.0V$ $V_{OUT} = 2.5V$ $V_{OUT} = 1.8V$
Load Regulation (Note 3)	$\Delta V_{OUT} / V_{OUT}$	-1.60 -2.25 -2.72 -3.00 -3.60 -1.60	$\pm 0.8$ $\pm 1.1$ $\pm 1.3$ $\pm 1.5$ $\pm 1.8$ $\pm 0.8$	+1.60 +2.25 +2.72 +3.00 +3.60 +1.60	%	$V_{OUT} = 5.0V, 1 \text{ mA} \leq I_{OUT} \leq 100 \text{ mA}$ $V_{OUT} = 4.0V, 1 \text{ mA} \leq I_{OUT} \leq 100 \text{ mA}$ $V_{OUT} = 3.3V, 1 \text{ mA} \leq I_{OUT} \leq 80 \text{ mA}$ $V_{OUT} = 3.0V, 1 \text{ mA} \leq I_{OUT} \leq 80 \text{ mA}$ $V_{OUT} = 2.5V, 1 \text{ mA} \leq I_{OUT} \leq 60 \text{ mA}$ $V_{OUT} = 1.8V, 1 \text{ mA} \leq I_{OUT} \leq 30 \text{ mA}$
Dropout Voltage	$V_{IN} - V_{OUT}$	— — — — — —	380 400 400 400 400 180	600 630 700 700 700 300	mV	$I_{OUT} = 200 \text{ mA}, V_R = 5.0V$ $I_{OUT} = 200 \text{ mA}, V_R = 4.0V$ $I_{OUT} = 160 \text{ mA}, V_R = 3.3V$ $I_{OUT} = 160 \text{ mA}, V_R = 3.0V$ $I_{OUT} = 120 \text{ mA}, V_R = 2.5V$ $I_{OUT} = 20 \text{ mA}, V_R = 1.8V$
Input Quiescent Current	$I_Q$	—	2.0	4.5	$\mu\text{A}$	$V_{IN} = V_R + 1.0V$
Line Regulation	$\frac{\Delta V_{OUT} \cdot 100}{\Delta V_{IN} \cdot V_{OUT}}$	—	0.2	0.3	%/V	$I_{OUT} = 40 \text{ mA}, (V_R + 1) \leq V_{IN} \leq 10.0V$
Input Voltage	$V_{IN}$	—	—	10	V	
Temperature Coefficient of Output Voltage	$TCV_{OUT}$	—	$\pm 100$	—	ppm/ $^\circ\text{C}$	$I_{OUT} = 40 \text{ mA}, -40^\circ\text{C} \leq T_A \leq +85^\circ\text{C}$ (Note 2)
Output Rise Time	$T_R$	—	200	—	$\mu\text{sec}$	10% $V_R$ to 90% $V_R, V_{IN} = 0V$ to $V_R + 1V, R_L = 25\Omega$ resistive

- 1:  $V_R$  is the nominal regulator output voltage. For example:  $V_R = 1.8V, 2.5V, 3.3V, 4.0V, 5.0V$ . The input voltage  $V_{IN} = V_R + 1.0V, I_{OUT} = 40 \text{ mA}$ .
- 2:  $TCV_{OUT} = (V_{OUT-HIGH} - V_{OUT-LOW}) \cdot 10^6 / (V_R \cdot \Delta\text{Temperature})$ ,  $V_{OUT-HIGH}$  = Highest voltage measured over the temperature range.  $V_{OUT-LOW}$  = Lowest voltage measured over the temperature range.
- 3: Load regulation is measured at a constant junction temperature using low duty cycle pulse testing.

# MCP1701A

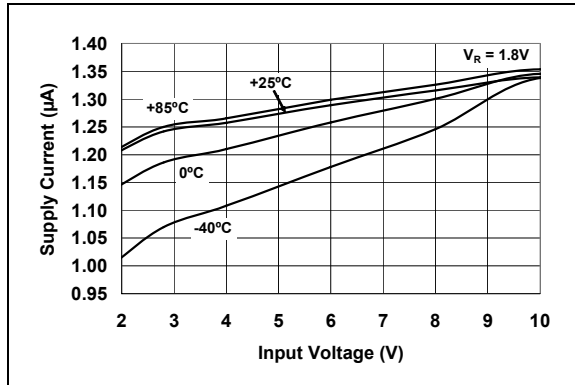
## TEMPERATURE CHARACTERISTICS

Electrical Specifications: Unless otherwise specified, $T_A = +25^\circ\text{C}$ .						
Parameters	Sym	Min	Typ	Max	Units	Conditions
<b>Temperature Ranges</b>						
Specified Temperature Range (I)	$T_A$	-40	—	+85	$^\circ\text{C}$	
Storage Temperature Range	$T_A$	-40	—	+125	$^\circ\text{C}$	
<b>Package Thermal Resistances</b>						
Thermal Resistance, 3L-SOT-23A	$\theta_{JA}$	—	335	—	$^\circ\text{C/W}$	Minimum trace width single layer application
		—	230	—	$^\circ\text{C/W}$	Typical FR4, 4-layer application
Thermal Resistance, 3L-SOT-89	$\theta_{JA}$	—	52	—	$^\circ\text{C/W}$	Typical, when mounted on 1 square inch of copper
Thermal Resistance, 3L-TO-92	$\theta_{JA}$	—	131.9	—	$^\circ\text{C/W}$	EIA/JEDEC JESD51-751-7 4-layer board

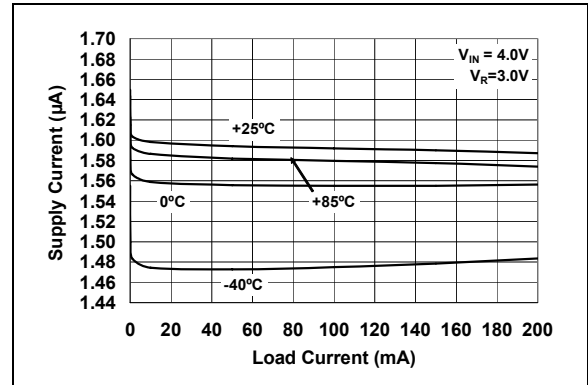
## 2.0 TYPICAL PERFORMANCE CURVES

**Note:** The graphs and tables provided following this note are a statistical summary based on a limited number of samples and are provided for informational purposes only. The performance characteristics listed herein are not tested or guaranteed. In some graphs or tables, the data presented may be outside the specified operating range (e.g., outside specified power supply range) and therefore outside the warranted range.

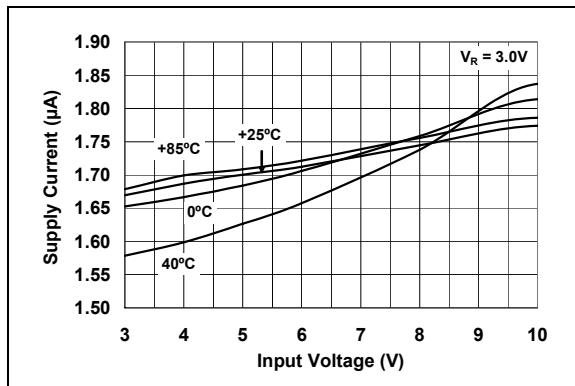
**Notes:** Unless otherwise specified,  $V_{OUT} = 1.8V, 3.0V, 5.0V$ ,  $T_A = +25^\circ C$ ,  $C_{IN} = 1 \mu F$  Tantalum,  $C_{OUT} = 1 \mu F$  Tantalum.



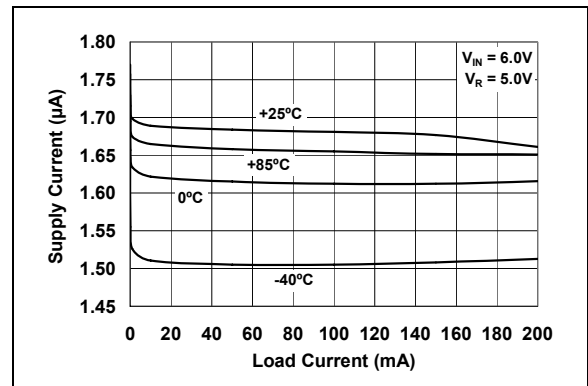
**FIGURE 2-1:** Supply Current vs. Input Voltage ( $V_R = 1.8V$ ).



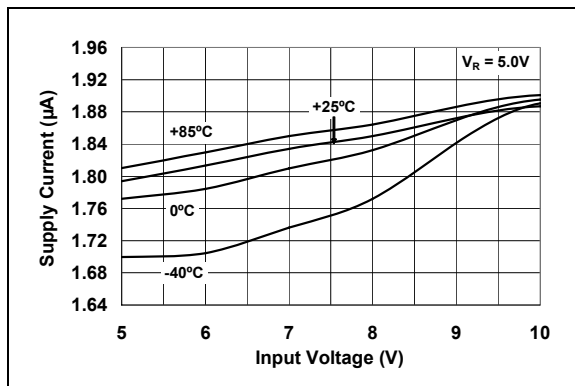
**FIGURE 2-4:** Supply Current vs. Load Current ( $V_R = 3.0V$ ).



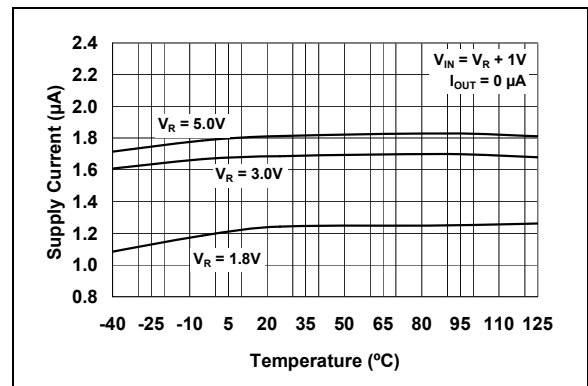
**FIGURE 2-2:** Supply Current vs. Input Voltage ( $V_R = 3.0V$ ).



**FIGURE 2-5:** Supply Current vs. Load Current ( $V_R = 5.0V$ ).



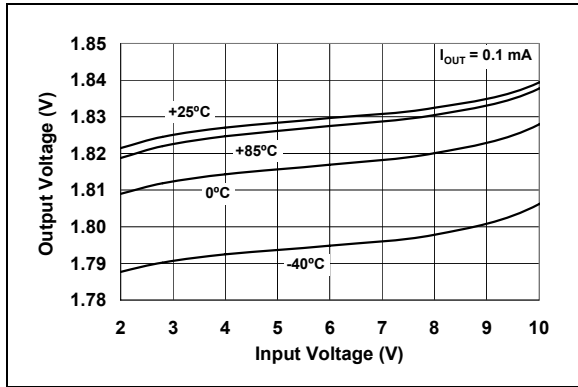
**FIGURE 2-3:** Supply Current vs. Input Voltage ( $V_R = 5.0V$ ).



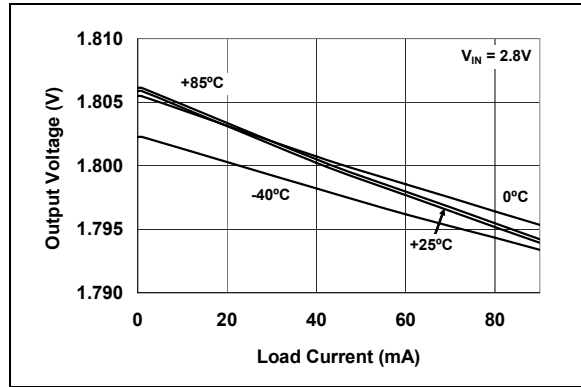
**FIGURE 2-6:** Supply Current vs. Temperature.

# MCP1701A

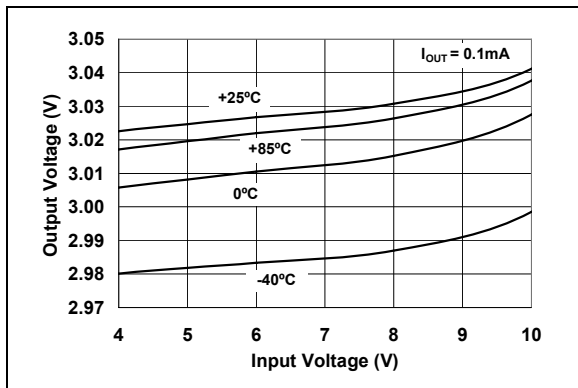
Note: Unless otherwise indicated,  $V_{OUT} = 1.8V, 3.0V, 5.0V$ ,  $T_A = +25^\circ C$ ,  $C_{IN} = 1 \mu F$  Tantalum,  $C_{OUT} = 1 \mu F$  Tantalum.



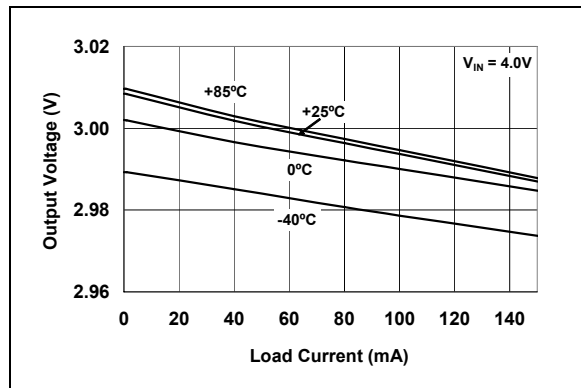
**FIGURE 2-7:** Output Voltage vs. Input Voltage ( $V_R = 1.8V$ ).



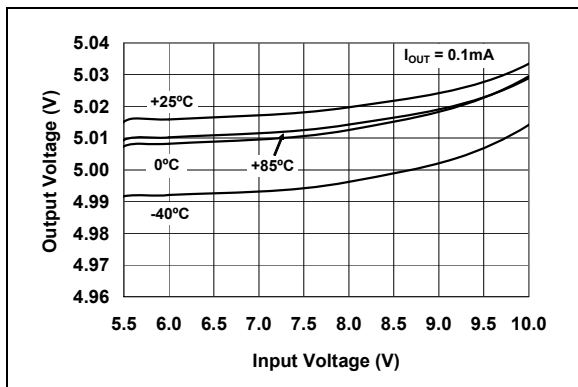
**FIGURE 2-10:** Output Voltage vs. Load Current ( $V_R = 1.8V$ ).



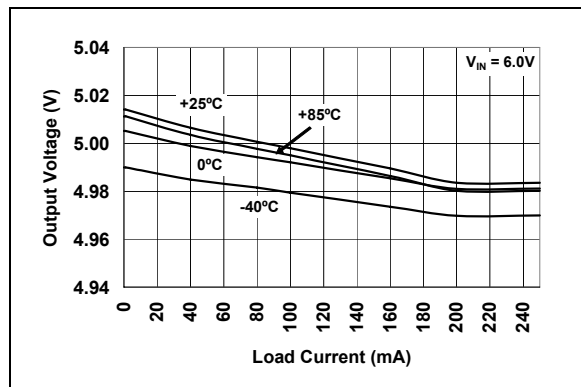
**FIGURE 2-8:** Output Voltage vs. Input Voltage ( $V_R = 3.0V$ ).



**FIGURE 2-11:** Output Voltage vs. Load Current ( $V_R = 3.0V$ ).

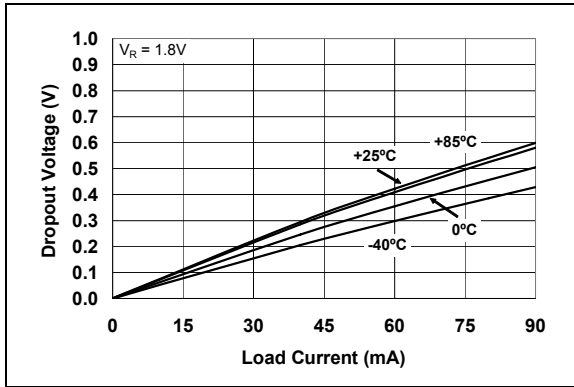


**FIGURE 2-9:** Output Voltage vs. Input Voltage ( $V_R = 5.0V$ ).

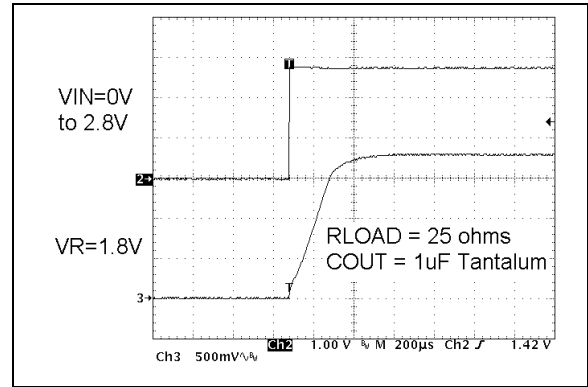


**FIGURE 2-12:** Output Voltage vs. Load Current ( $V_R = 5.0V$ ).

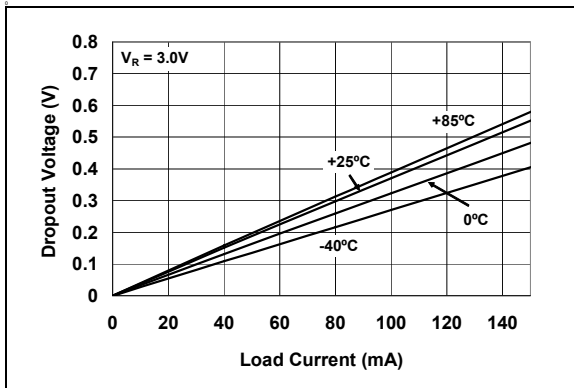
**Note:** Unless otherwise indicated,  $V_{OUT} = 1.8V, 3.0V, 5.0V$ ,  $T_A = +25^\circ C$ ,  $C_{IN} = 1 \mu F$  Tantalum,  $C_{OUT} = 1 \mu F$  Tantalum.



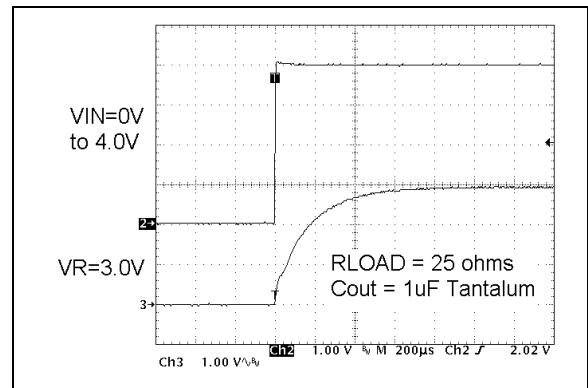
**FIGURE 2-13:** Dropout Voltage vs. Load Current ( $V_R = 1.8V$ ).



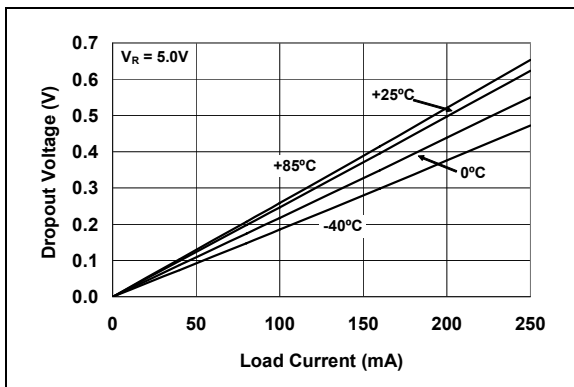
**FIGURE 2-16:** Start-up From  $V_{IN}$  ( $V_R = 1.8V$ ).



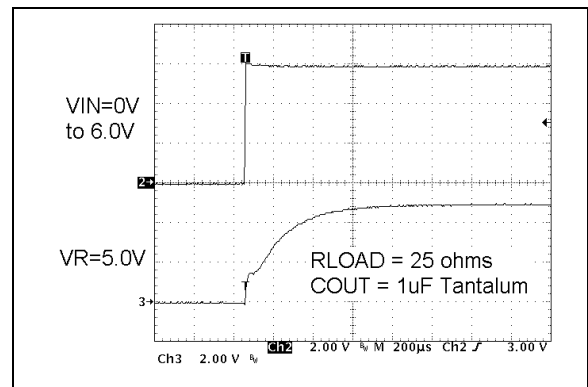
**FIGURE 2-14:** Dropout Voltage vs. Load Current ( $V_R = 3.0V$ ).



**FIGURE 2-17:** Start-up From  $V_{IN}$  ( $V_R = 3.0V$ ).



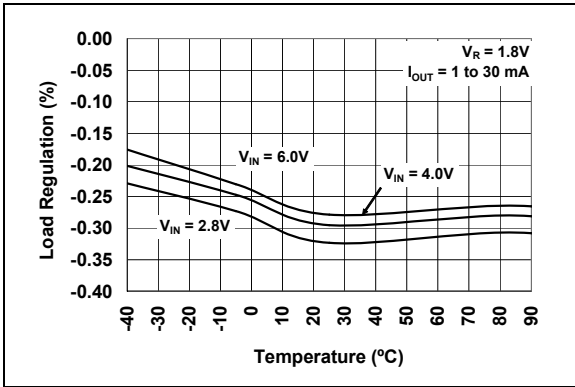
**FIGURE 2-15:** Dropout Voltage vs. Load Current ( $V_R = 5.0V$ ).



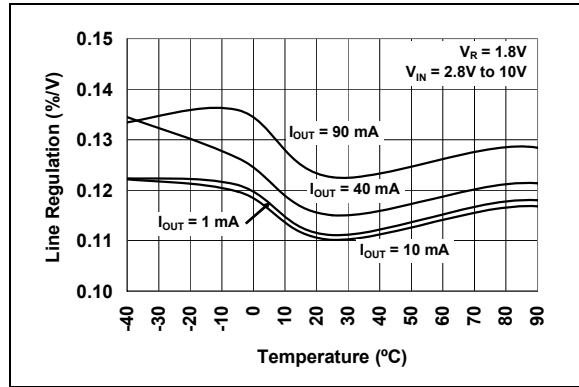
**FIGURE 2-18:** Start-up From  $V_{IN}$  ( $V_R = 5.0V$ ).

# MCP1701A

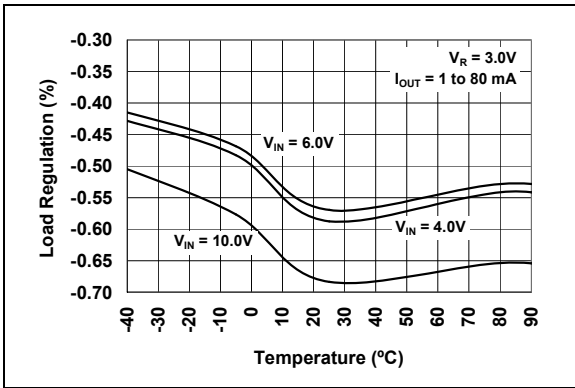
Note: Unless otherwise indicated,  $V_{OUT} = 1.8V, 3.0V, 5.0V$ ,  $T_A = +25^\circ C$ ,  $C_{IN} = 1 \mu F$  Tantalum,  $C_{OUT} = 1 \mu F$  Tantalum.



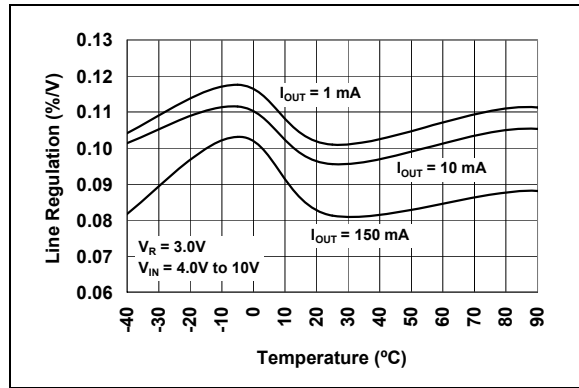
**FIGURE 2-19:** Load Regulation vs. Temperature ( $V_R = 1.8V$ ).



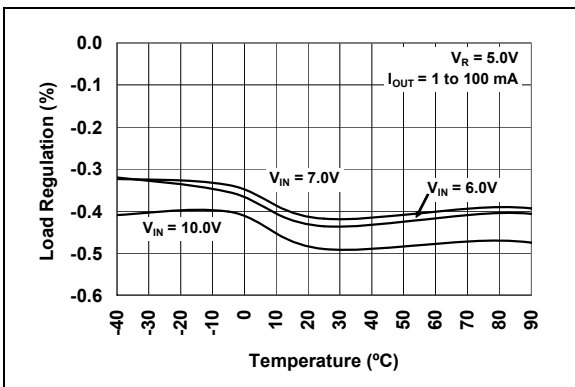
**FIGURE 2-22:** Line Regulation vs. Temperature ( $V_R = 1.8V$ ).



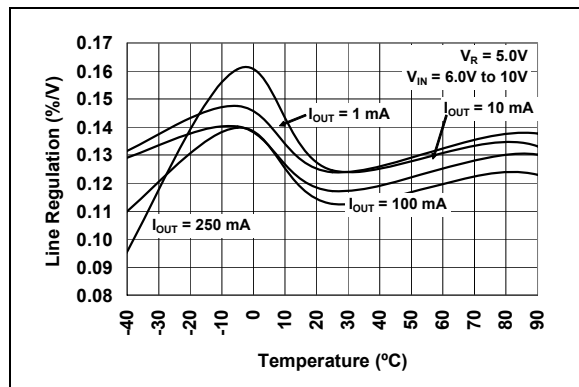
**FIGURE 2-20:** Load Regulation vs. Temperature ( $V_R = 3.0V$ ).



**FIGURE 2-23:** Line Regulation vs. Temperature ( $V_R = 3.0V$ ).



**FIGURE 2-21:** Load Regulation vs. Temperature ( $V_R = 5.0V$ ).



**FIGURE 2-24:** Line Regulation vs. Temperature ( $V_R = 5.0V$ ).



## 3.0 PIN DESCRIPTIONS

The descriptions of the pins are listed in Table 3-1.

**TABLE 3-1: PIN FUNCTION TABLE**

Pin No. SOT-23A	Pin No. SOT-89	Pin No. TO-92	Name	Function
1	1	1	GND	Ground Terminal
2	3	3	V <sub>OUT</sub>	Regulated Voltage Output
3	2	2	V <sub>IN</sub>	Unregulated Supply Input

### 3.1 Ground Terminal (GND)

Regulator ground. Tie GND to the negative side of the output and the negative side of the input capacitor. Only the LDO bias current (2  $\mu$ A, typ.) flows out of this pin, there is no high current. The LDO output regulation is referenced to this pin. Minimize voltage drops between this pin and the negative side of the load.

### 3.2 Regulated Voltage Output (V<sub>OUT</sub>)

Connect V<sub>OUT</sub> to the positive side of the load and the positive terminal of the output capacitor. The positive side of the output capacitor should be physically located as close as possible to the LDO V<sub>OUT</sub> pin. The current flowing out of this pin is equal to the DC load current.

### 3.3 Unregulated Supply Input (V<sub>IN</sub>)

Connect the input supply voltage and the positive side of the input capacitor to V<sub>IN</sub>. Like all low-dropout linear regulators, low source impedance is necessary for the stable operation of the LDO. The amount of capacitance required to ensure low source impedance will depend on the proximity of the input source capacitors or battery type. The input capacitor should be physically located as close as possible to the V<sub>IN</sub> pin. For most applications, 1  $\mu$ F of capacitance will ensure stable operation of the LDO circuit. For applications that have load currents below 100 mA, the input capacitance requirement can be lowered. The type of capacitor used can be ceramic, tantalum or aluminum electrolytic. The low equivalent series resistance characteristics of the ceramic will yield better noise and PSRR performance at high frequency. The current flow into this pin is equal to the DC load current, plus the LDO bias current (2  $\mu$ A, typ.).

# MCP1701A

## 4.0 DETAILED DESCRIPTION

The MCP1701A is a low-quiescent current, precision, fixed-output voltage LDO. Unlike bipolar regulators, the MCP1701A supply current does not increase proportionally with load current.

### 4.1 Output Capacitor

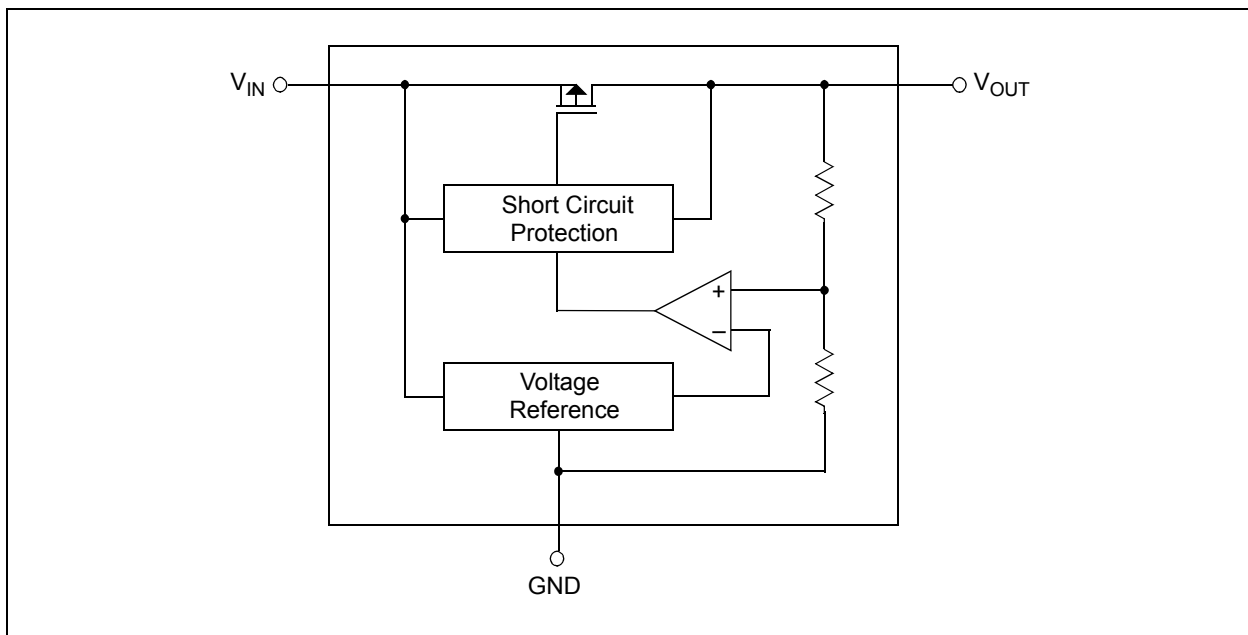
A minimum of 1  $\mu\text{F}$  output capacitor is required. The output capacitor should have an ESR greater than 0.1 $\Omega$  and less than 5 $\Omega$ , plus a resonant frequency above 1 MHz. Larger output capacitors can be used to improve supply noise rejection and transient response. Care should be taken when increasing  $C_{\text{OUT}}$  to ensure that the input impedance is not high enough to cause high input impedance oscillation.

### 4.2 Input Capacitor

A 1  $\mu\text{F}$  input capacitor is recommended for most applications when the input impedance is on the order of 10 $\Omega$ . Larger input capacitance may be required for stability when operating from a battery input, or if there is a large distance from the input source to the LDO. When large values of output capacitance are used, the input capacitance should be increased to prevent high source impedance oscillations.

### 4.3 Overcurrent

The MCP1701 internal circuitry monitors the amount of current flowing through the P-channel pass transistor. In the event of a short circuit or excessive output current, the MCP1701 will act to limit the output current.



**FIGURE 4-1:** MCP1701A Block Diagram.

## 5.0 THERMAL CONSIDERATIONS

### 5.1 Power Dissipation

The amount of power dissipated internal to the LDO linear regulator is the sum of the power dissipation within the linear pass device (P-channel MOSFET) and the quiescent current required to bias the internal reference and error amplifier. The internal linear pass device power dissipation is calculated as shown in Equation 5-1.

#### EQUATION 5-1:

$$P_D (\text{Pass Device}) = (V_{IN} - V_{OUT}) \times I_{OUT}$$

The internal power dissipation, as a result of the bias current for the LDO internal reference and error amplifier, is calculated as shown in Equation 5-2.

#### EQUATION 5-2:

$$P_D (\text{Bias}) = V_{IN} \times I_{GND}$$

The total internal power dissipation is the sum of  $P_D$  (pass device) and  $P_D$  (bias).

#### EQUATION 5-3:

$$P_{TOTAL} = P_D (\text{Pass Device}) + P_D (\text{Bias})$$

For the MCP1701A, the internal quiescent bias current is so low (2  $\mu$ A, typ.) that the  $P_D$  (bias) term of the power dissipation equation can be ignored. The maximum power dissipation can be estimated by using the maximum input voltage and the minimum output voltage to obtain a maximum voltage differential between input and output. The next step would be to multiply the maximum voltage differential by the maximum output current.

#### EQUATION 5-4:

$$P_D = (V_{INMAX} - V_{OUTMIN}) \times I_{OUTMAX}$$

Given:

$$\begin{aligned} V_{IN} &= 3.3V \text{ to } 4.1V \\ V_{OUT} &= 3.0V \pm 2\% \\ I_{OUT} &= 1 \text{ mA to } 100 \text{ mA} \\ T_{AMAX} &= 55^\circ\text{C} \\ P_{MAX} &= (4.1V - (3.0V \times 0.98)) \times 100 \text{ mA} \\ P_{MAX} &= 116.0 \text{ milliwatts} \end{aligned}$$

To determine the junction temperature of the device, the thermal resistance from junction-to-ambient must be known. The 3-pin SOT-23 thermal resistance from junction-to-air ( $R_{\theta JA}$ ) is estimated to be approximately 335° C/W. The SOT-89  $R_{\theta JA}$  is estimated to be approximately 52° C/W when mounted on 1 square inch of copper. The  $R_{\theta JA}$  will vary with physical layout, airflow and other application-specific conditions.

The device junction temperature is determined by calculating the junction temperature rise above ambient, then adding the rise to the ambient temperature.

#### EQUATION 5-5: JUNCTION TEMPERATURE – SOT-23 EXAMPLE:

$$\begin{aligned} T_J &= P_{DMAX} \times R_{\theta JA} + T_A \\ T_J &= 116.0 \text{ milliwatts} \times 335^\circ\text{C/W} + 55^\circ\text{C} \\ T_J &= 93.9^\circ\text{C} \end{aligned}$$

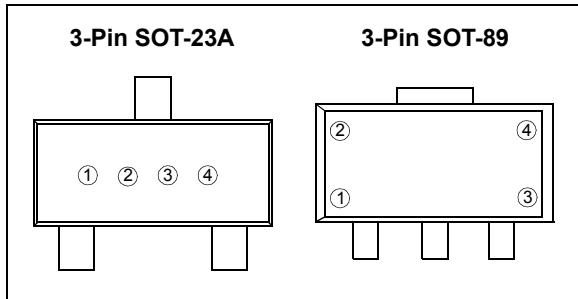
#### EQUATION 5-6: JUNCTION TEMPERATURE – SOT-89 EXAMPLE:

$$\begin{aligned} T_J &= 116.0 \text{ milliwatts} \times 52^\circ\text{C/W} + 55^\circ\text{C} \\ T_J &= 61^\circ\text{C} \end{aligned}$$

# MCP1701A

## 6.0 PACKAGING INFORMATION

### 6.1 Package Marking Information



① represents first voltage digit  
1V, 2V, 3V, 4V, 5V, 6V

Ex: 3.xV = ③ ○ ○ ○

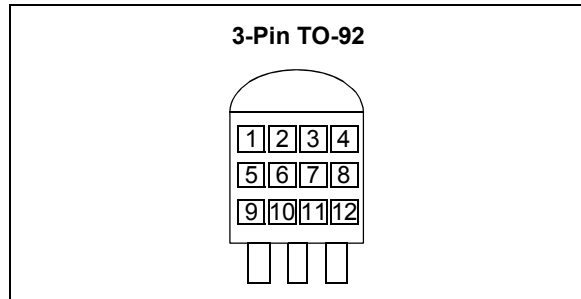
② represents first decimal place voltage (x.0 - x.9)

Ex: 3.4V = ③ ④ ○ ○

Symbol	Voltage	Symbol	Voltage
A	x.0	F	x.5
B	x.1	H	x.6
C	x.2	K	x.7
D	x.3	L	x.8
E	x.4	M	x.9

③ represents polarity  
0 = Positive (fixed)

④ represents assembly lot number



①, ②, ③ & ④ = 701A (fixed)

⑤ represents first voltage digit (1-6)

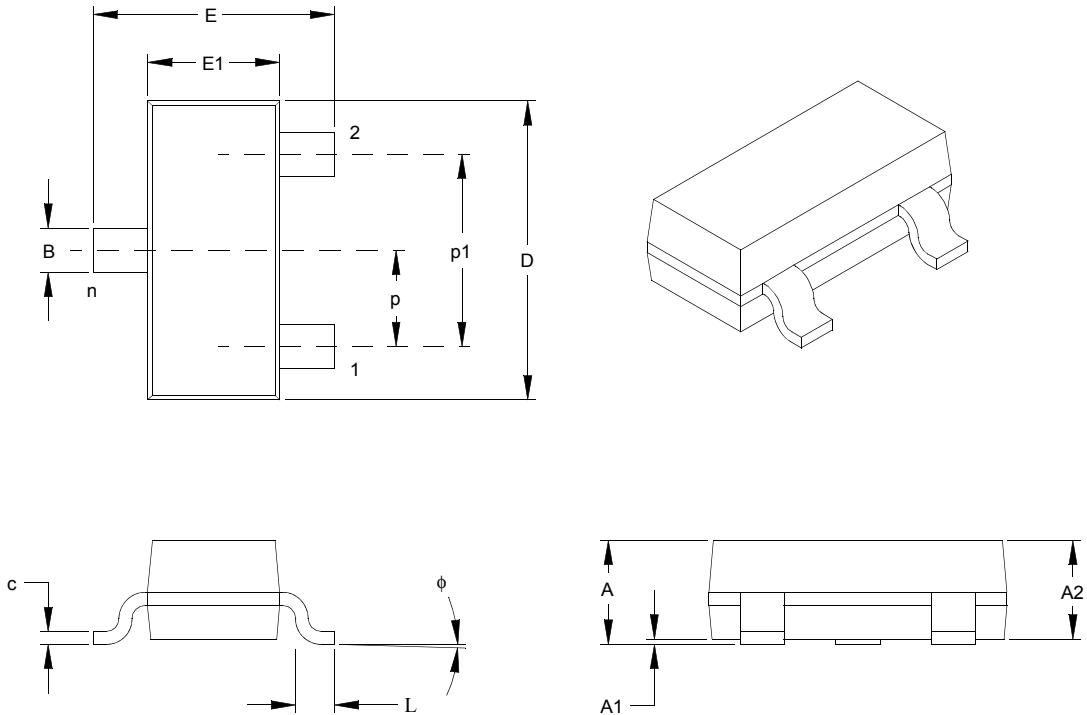
⑥ represents first voltage decimal (0-9)

⑦ represents extra feature code: fixed: 0

⑧ represents regulation accuracy  
2 =  $\pm 2.0\%$  (standard)

⑨, ⑩, ⑪ & ⑫ represents assembly lot number

## 3-Lead Plastic Small Outline Transistor (CB) (SOT23)



Dimension Limits	Units	INCHES			MILLIMETERS*		
		MIN	NOM	MAX	MIN	NOM	MAX
Number of Pins	n	3			3		
Pitch	p	.037 BSC			0.95 BSC		
Outside lead pitch (basic)	p1	.075 BSC			1.90 BSC		
Overall Height	A	.035		.055	0.90	–	1.40
Molded Package Thickness	A2	.035	–	.051	0.90	–	1.30
Standoff	A1	.000	–	.006	0.00	–	0.15
Overall Width	E	.098	–	.118	2.50	–	3.00
Molded Package Width	E1	.055	–	.071	1.40	–	1.80
Overall Length	D	.106	–	.122	2.70	–	3.10
Foot Length	L	.014	–	.022	0.35	–	0.55
Foot Angle	φ	0°	–	10°	0°	–	10°
Lead Thickness	c	.004	–	.014	0.10	–	0.35
Lead Width	B	.012	–	.019	0.30	–	0.50

\* Controlling Parameter

**Notes:**

Dimensions D and E1 do not include mold flash or protrusions. Mold flash or protrusions shall not exceed .005" (0.127mm) per side.

BSC: Basic Dimension. Theoretically exact value shown without tolerances.

See ASME Y14.5M

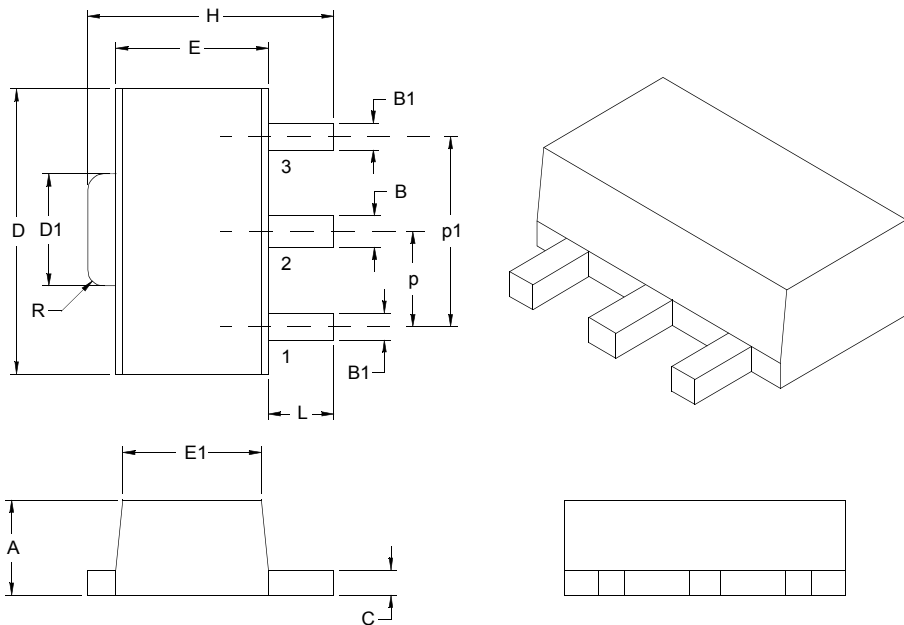
EIAJ Equivalent: SC-59

Drawing No. C04-130

Revised 09-14-05

# MCP1701A

## 3-Lead Plastic Small Outline Transistor (MB) (SOT89)



Dimension Limits	Units	INCHES		MILLIMETERS*	
		MIN	MAX	MIN	MAX
Pitch	P	.059 BSC		1.50 BSC	
Outside Lead Pitch	p1	.118 BSC		3.00 BSC	
Overall Height	A	.055	.063	1.40	1.60
Overall Width	H	.155	.167	3.94	4.25
Molded Package Width at Base	E	.090	.102	2.29	2.60
Molded Package Width at Top	E1	.084	.090	2.13	2.29
Overall Length	D	.173	.181	4.40	4.60
Tab Length	D1	.064	.072	1.62	1.83
Tab Corner Radii	R	.010		0.254	
Foot Length	L	.035	.047	0.89	1.20
Lead Thickness	c	.014	.019	0.35	0.48
Lead 2 Width	B	.017	.022	0.43	0.56
Leads 1 & 3 Width	B1	.014	.019	0.36	0.48

\* Controlling Parameter

**Notes:**

Dimensions D and E1 do not include mold flash or protrusions. Mold flash or protrusions shall not exceed .005" (0.127mm) per side.

BSC: Basic Dimension. Theoretically exact value shown without tolerances.

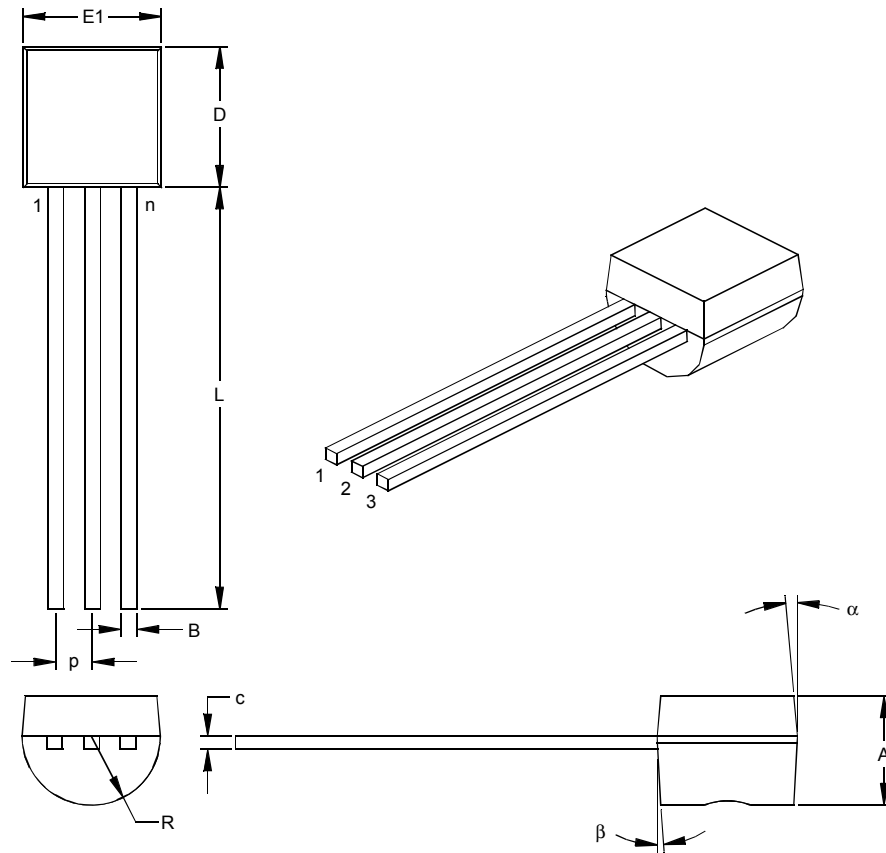
See ASME Y14.5M

JEDEC Equivalent: TO-243

Drawing No. C04-029

Revised 09-19-03

## 3-Lead Plastic Transistor Outline (TO) (TO-92)



Dimension Limits	Units	INCHES*			MILLIMETERS		
		MIN	NOM	MAX	MIN	NOM	MAX
Number of Pins	n	3			3		
Pitch	p		.050			1.27	
Bottom to Package Flat	A	.130	.143	.155	3.30	3.62	3.94
Overall Width	E1	.175	.186	.195	4.45	4.71	4.95
Overall Length	D	.170	.183	.195	4.32	4.64	4.95
Molded Package Radius	R	.085	.090	.095	2.16	2.29	2.41
Tip to Seating Plane	L	.500	.555	.610	12.70	14.10	15.49
Lead Thickness	c	.014	.017	.020	0.36	0.43	0.51
Lead Width	B	.016	.019	.022	0.41	0.48	0.56
Mold Draft Angle Top	$\alpha$	4	5	6	4	5	6
Mold Draft Angle Bottom	$\beta$	2	3	4	2	3	4

\* Controlling Parameter

**Notes:**

Dimensions D and E1 do not include mold flash or protrusions. Mold flash or protrusions shall not exceed .010" (0.254mm) per side.

JEDEC Equivalent: TO-92

Drawing No. C04-101

# MCP1701A

---

NOTES:



## APPENDIX A: REVISION HISTORY

### Revision A (February 2006)

- Original Release of this Document.

# MCP1701A

---

NOTES:

## PRODUCT IDENTIFICATION SYSTEM

To order or obtain information, e.g., on pricing or delivery, refer to the factory or the listed sales office.

<u>PART NO.</u>	<u>X-</u>	<u>XX</u>	<u>X</u>	<u>X</u>	<u>X/</u>	<u>XX</u>
Device	Tape and Reel	Output Voltage	Feature Code	Tolerance	Temp.	Package
Device:	MCP1701A: 2 $\mu$ A Low-Dropout Positive Voltage Regulator					
Tape and Reel:	T = Tape and Reel					
Output Voltage:	18 = 1.8V "Standard" 25 = 2.5V "Standard" 30 = 3.0V "Standard" 33 = 3.3V "Standard" 50 = 5.0V "Standard" *Contact factory for other output voltage options.					
Extra Feature Code:	0 = Fixed					
Tolerance:	2 = 2.0% (Standard)					
Temperature:	I = -40°C to +85°C					
Package Type:	CB = 3-Pin SOT-23A (equivalent to EIAJ SC-59) MB = 3-Pin SOT-89 TO = 3-Pin TO-92					
<b>Examples:</b>						
a) MCP1701AT-1802I/CB: 1.8V LDO Positive Voltage Regulator, SOT-23A-3 pkg.						
b) MCP1701AT-1802I/MB: 1.8V LDO Positive Voltage Regulator, SOT89-3 pkg.						
c) MCP1701AT-2502I/CB: 2.5V LDO Positive Voltage Regulator, SOT-23A-3 pkg.						
d) MCP1701AT-3002I/CB: 3.0V LDO Positive Voltage Regulator, SOT-23A-3 pkg.						
e) MCP1701AT-3002I/MB: 3.0V LDO Positive Voltage Regulator, SOT89-3 pkg.						
f) MCP1701AT-3302I/CB: 3.3V LDO Positive Voltage Regulator, SOT-23A-3 pkg.						
g) MCP1701AT-3302I/MB: 3.3V LDO Positive Voltage Regulator, SOT89-3 pkg.						
h) MCP1701AT-5002I/CB: 5.0V LDO Positive Voltage Regulator, SOT-23A-3 pkg.						
i) MCP1701AT-5002I/MB: 5.0V LDO Positive Voltage Regulator, SOT89-3 pkg.						

# MCP1701A

---

NOTES:

---

**Note the following details of the code protection feature on Microchip devices:**

- Microchip products meet the specification contained in their particular Microchip Data Sheet.
- Microchip believes that its family of products is one of the most secure families of its kind on the market today, when used in the intended manner and under normal conditions.
- There are dishonest and possibly illegal methods used to breach the code protection feature. All of these methods, to our knowledge, require using the Microchip products in a manner outside the operating specifications contained in Microchip's Data Sheets. Most likely, the person doing so is engaged in theft of intellectual property.
- Microchip is willing to work with the customer who is concerned about the integrity of their code.
- Neither Microchip nor any other semiconductor manufacturer can guarantee the security of their code. Code protection does not mean that we are guaranteeing the product as "unbreakable."

Code protection is constantly evolving. We at Microchip are committed to continuously improving the code protection features of our products. Attempts to break Microchip's code protection feature may be a violation of the Digital Millennium Copyright Act. If such acts allow unauthorized access to your software or other copyrighted work, you may have a right to sue for relief under that Act.

---

Information contained in this publication regarding device applications and the like is provided only for your convenience and may be superseded by updates. It is your responsibility to ensure that your application meets with your specifications. MICROCHIP MAKES NO REPRESENTATIONS OR WARRANTIES OF ANY KIND WHETHER EXPRESS OR IMPLIED, WRITTEN OR ORAL, STATUTORY OR OTHERWISE, RELATED TO THE INFORMATION, INCLUDING BUT NOT LIMITED TO ITS CONDITION, QUALITY, PERFORMANCE, MERCHANTABILITY OR FITNESS FOR PURPOSE. Microchip disclaims all liability arising from this information and its use. Use of Microchip devices in life support and/or safety applications is entirely at the buyer's risk, and the buyer agrees to defend, indemnify and hold harmless Microchip from any and all damages, claims, suits, or expenses resulting from such use. No licenses are conveyed, implicitly or otherwise, under any Microchip intellectual property rights.

**Trademarks**

The Microchip name and logo, the Microchip logo, Accuron, dsPIC, KEELOQ, microID, MPLAB, PIC, PICmicro, PICSTART, PRO MATE, PowerSmart, rfPIC, and SmartShunt are registered trademarks of Microchip Technology Incorporated in the U.S.A. and other countries.


AmpLab, FilterLab, Migratable Memory, MXDEV, MXLAB, PICMASTER, SEEVAL, SmartSensor and The Embedded Control Solutions Company are registered trademarks of Microchip Technology Incorporated in the U.S.A.

Analog-for-the-Digital Age, Application Maestro, dsPICDEM, dsPICDEM.net, dsPICworks, ECAN, ECONOMONITOR, FanSense, FlexROM, fuzzyLAB, In-Circuit Serial Programming, ICSP, ICEPIC, Linear Active Thermistor, MPASM, MPLIB, MPLINK, MPSIM, PICkit, PICDEM, PICDEM.net, PICLAB, PICtail, PowerCal, PowerInfo, PowerMate, PowerTool, Real ICE, rLAB, rfPICDEM, Select Mode, Smart Serial, SmartTel, Total Endurance, UNI/O, WiperLock and Zena are trademarks of Microchip Technology Incorporated in the U.S.A. and other countries.

SQTP is a service mark of Microchip Technology Incorporated in the U.S.A.

All other trademarks mentioned herein are property of their respective companies.

© 2006, Microchip Technology Incorporated, Printed in the U.S.A., All Rights Reserved.

 Printed on recycled paper.

**QUALITY MANAGEMENT SYSTEM  
CERTIFIED BY DNV  
== ISO/TS 16949:2002 ==**

*Microchip received ISO/TS-16949:2002 quality system certification for its worldwide headquarters, design and wafer fabrication facilities in Chandler and Tempe, Arizona and Mountain View, California in October 2003. The Company's quality system processes and procedures are for its PICmicro® 8-bit MCUs, KEELOQ® code hopping devices, Serial EEPROMs, microperipherals, nonvolatile memory and analog products. In addition, Microchip's quality system for the design and manufacture of development systems is ISO 9001:2000 certified.*



---

---

## WORLDWIDE SALES AND SERVICE

---

---

### AMERICAS

#### Corporate Office

2355 West Chandler Blvd.  
Chandler, AZ 85224-6199  
Tel: 480-792-7200  
Fax: 480-792-7277  
Technical Support:  
<http://support.microchip.com>  
Web Address:  
[www.microchip.com](http://www.microchip.com)

#### Atlanta

Alpharetta, GA  
Tel: 770-640-0034  
Fax: 770-640-0307

#### Boston

Westborough, MA  
Tel: 774-760-0087  
Fax: 774-760-0088

#### Chicago

Itasca, IL  
Tel: 630-285-0071  
Fax: 630-285-0075

#### Dallas

Addison, TX  
Tel: 972-818-7423  
Fax: 972-818-2924

#### Detroit

Farmington Hills, MI  
Tel: 248-538-2250  
Fax: 248-538-2260

#### Kokomo

Kokomo, IN  
Tel: 765-864-8360  
Fax: 765-864-8387

#### Los Angeles

Mission Viejo, CA  
Tel: 949-462-9523  
Fax: 949-462-9608

#### San Jose

Mountain View, CA  
Tel: 650-215-1444  
Fax: 650-961-0286

#### Toronto

Mississauga, Ontario,  
Canada  
Tel: 905-673-0699  
Fax: 905-673-6509

### ASIA/PACIFIC

#### Australia - Sydney

Tel: 61-2-9868-6733  
Fax: 61-2-9868-6755

#### China - Beijing

Tel: 86-10-8528-2100  
Fax: 86-10-8528-2104

#### China - Chengdu

Tel: 86-28-8676-6200  
Fax: 86-28-8676-6599

#### China - Fuzhou

Tel: 86-591-8750-3506  
Fax: 86-591-8750-3521

#### China - Hong Kong SAR

Tel: 852-2401-1200  
Fax: 852-2401-3431

#### China - Qingdao

Tel: 86-532-8502-7355  
Fax: 86-532-8502-7205

#### China - Shanghai

Tel: 86-21-5407-5533  
Fax: 86-21-5407-5066

#### China - Shenyang

Tel: 86-24-2334-2829  
Fax: 86-24-2334-2393

#### China - Shenzhen

Tel: 86-755-8203-2660  
Fax: 86-755-8203-1760

#### China - Shunde

Tel: 86-757-2839-5507  
Fax: 86-757-2839-5571

#### China - Wuhan

Tel: 86-27-5980-5300  
Fax: 86-27-5980-5118

#### China - Xian

Tel: 86-29-8833-7250  
Fax: 86-29-8833-7256

### ASIA/PACIFIC

#### India - Bangalore

Tel: 91-80-4182-8400  
Fax: 91-80-4182-8422

#### India - New Delhi

Tel: 91-11-5160-8631  
Fax: 91-11-5160-8632

#### India - Pune

Tel: 91-20-2566-1512  
Fax: 91-20-2566-1513

#### Japan - Yokohama

Tel: 81-45-471-6166  
Fax: 81-45-471-6122

#### Korea - Gumi

Tel: 82-54-473-4301  
Fax: 82-54-473-4302

#### Korea - Seoul

Tel: 82-2-554-7200  
Fax: 82-2-558-5932 or  
82-2-558-5934

#### Malaysia - Penang

Tel: 60-4-646-8870  
Fax: 60-4-646-5086

#### Philippines - Manila

Tel: 63-2-634-9065  
Fax: 63-2-634-9069

#### Singapore

Tel: 65-6334-8870  
Fax: 65-6334-8850

#### Taiwan - Hsin Chu

Tel: 886-3-572-9526  
Fax: 886-3-572-6459

#### Taiwan - Kaohsiung

Tel: 886-7-536-4818  
Fax: 886-7-536-4803

#### Taiwan - Taipei

Tel: 886-2-2500-6610  
Fax: 886-2-2508-0102

#### Thailand - Bangkok

Tel: 66-2-694-1351  
Fax: 66-2-694-1350

### EUROPE

#### Austria - Wels

Tel: 43-7242-2244-399  
Fax: 43-7242-2244-393

#### Denmark - Copenhagen

Tel: 45-4450-2828  
Fax: 45-4485-2829

#### France - Paris

Tel: 33-1-69-53-63-20  
Fax: 33-1-69-30-90-79

#### Germany - Munich

Tel: 49-89-627-144-0  
Fax: 49-89-627-144-44

#### Italy - Milan

Tel: 39-0331-742611  
Fax: 39-0331-466781

#### Netherlands - Drunen

Tel: 31-416-690399  
Fax: 31-416-690340

#### Spain - Madrid

Tel: 34-91-708-08-90  
Fax: 34-91-708-08-91

#### UK - Wokingham

Tel: 44-118-921-5869  
Fax: 44-118-921-5820

02/16/06