

4850 N

AC axial compact fan



ebm-papst St. Georgen GmbH & Co. KG

Hermann-Papst-Straße 1

78112 St. Georgen

Phone: +49 7724 81-0

Fax: +49 7724 81-1309

www.ebmpapst.com

info2@de.ebmpapst.com

Nominal data

Type	4850 N	
Nominal voltage	[VAC]	230
Frequency	[Hz]	50
Speed	[min ⁻¹]	1800
Power input	[W]	10,0
Min. ambient temperature	[°C]	-10
Max. ambient temperature	[°C]	70
Air flow	[m ³ /h]	100
Sound power level	[B]	4,4
Sound pressure level	[dB(A)]	32

ml = max. load · me = max. efficiency · rfa = running at free air · cs = customer specs · cu = customer unit
Subject to alterations

Technical features

Dimensions	119 x 119 x 38 mm
General description	AC fan with external rotor shaded-pole motor.
Connection line	2 flat plugs 3.0 x 0.5 mm. Housing with grounding lugs for screw M4 and UNC.
Direction of protection	Right, looking at rotor
Direction of air flow	Inlet over bars
Bearing	Sintec sleeve bearing system
Lifetime L10 at 40 °C	57500 h
Lifetime L10 at maximum temperature	27500 h
Mass	0.550 kg
Housing material	Metal
Material of impeller	Metal
Motor protection	Protected from overload using impedance protection
Option	Variants optionally available with reinforced mounting flanges and customizable single-strand wiring.
Approval	VDE, CSA, UL, CE

Product drawing

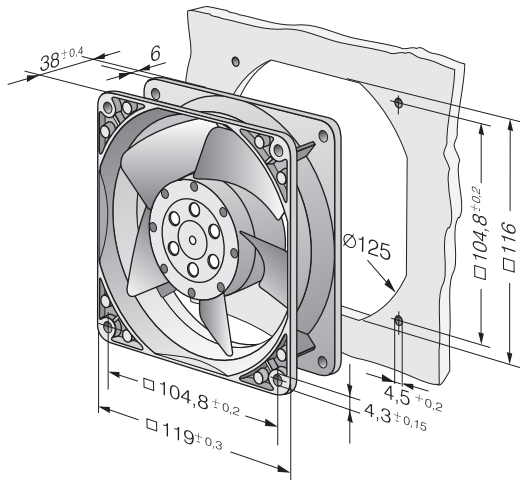

Charts: Air flow

