

60x60x25 mm

16.0~27.0 CFM



Specifications

	Bearing	Rating Voltage	Power Current	Power Consumption	Speed	Air Flow	Static Pressure	Noise	Weight	Curve
	● VAPO	(VDC)	(mA)	(WATTS)	(RPM)	(CFM)	(Inch-H ₂ O)	(dB(A))	(g)	
MB60251VX-000U-A99	●	12	200	2.40	5200	27.0	0.31	36.5	57.0	1
MB60251V1-000U-A99	●	12	125	1.50	4500	23.5	0.21	33.5	57.0	2
MB60251V2-000U-A99	●	12	74	0.89	3800	19.3	0.15	29.0	57.0	3
MB60251V3-000U-A99	●	12	50	0.60	3100	16.0	0.10	21.0	57.0	4
MB60252VX-000U-A99	●	24	110	2.64	5200	27.0	0.31	36.5	57.0	1
MB60252V1-000U-A99	●	24	70	1.68	4500	23.5	0.21	33.5	57.0	2
MB60252V2-000U-A99	●	24	48	1.16	3800	19.3	0.15	29.0	57.0	3
MB60252V3-000U-A99	●	24	32	0.77	3100	16.0	0.10	21.0	57.0	4

Model	Bearing	Rating Voltage	Power Current	Power Consumption	Speed	Air Flow	Static Pressure	Noise	Weight	Curve
	○ 2BALL Sleeve	(VDC)	(mA)	(WATTS)	(RPM)	(CFM)	(Inch-H ₂ O)	(dB(A))	(g)	
EB60251S1-000U-999	○	12	135	1.62	4500	23.5	0.21	33.5	55.0	2
EB60251S2-000U-999	○	12	89	1.07	3800	19.3	0.15	29.0	55.0	3
EB60251S3-000U-999	○	12	64	0.77	3100	16.0	0.10	21.0	55.0	4
EB60252S1-000U-999	○	24	75	1.80	4500	23.5	0.21	33.5	57.0	2
EB60252S2-000U-999	○	24	48	1.16	3800	19.3	0.15	29.0	57.0	3
EB60252S3-000U-999	○	24	35	0.84	3100	16.0	0.10	21.0	57.0	4

Air Flow-Static Pressure Characteristics

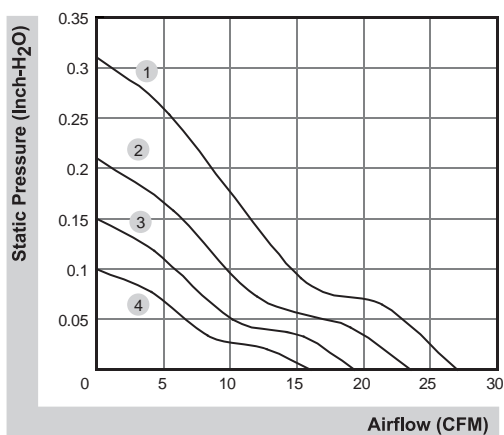

External dimensions(mm)

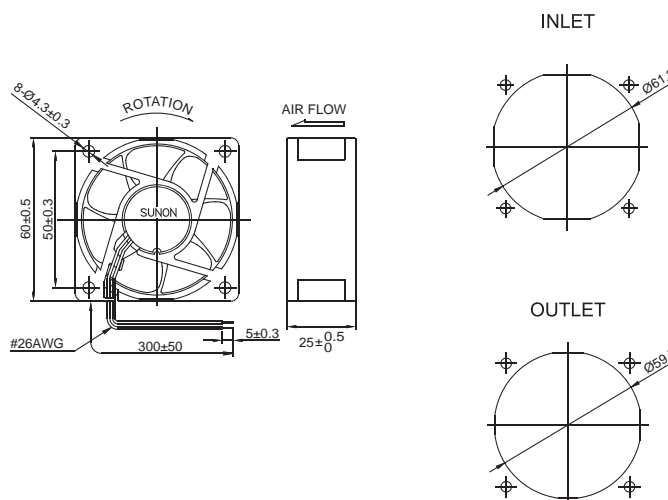

*All model could be customized. Please contact with Sunon Sales.

*Specifications are subject to change without notice. Please Visit SUNON website at <http://www.sunon.com> for update information.