



# MC4558

## LINEAR INTEGRATED CIRCUIT

### DUAL OPERATIONAL AMPLIFIER

■ DESCRIPTION

The UTC **MC4558** is a monolithic integrated circuit designed for dual operational amplifier.

■ FEATURES

- \* No frequency compensation required
- \* No latch-up
- \* Large common mode and differential voltage range
- \* Parameter tracking over temperature range
- \* Gain and phase match between amplifiers
- \* Internally frequency compensated
- \* Low noise input transistors

■ ORDERING INFORMATION

Ordering Number		Package	Packing
Lead Free	Halogen Free		
MC4558L-D08-T	MC4558G-D08-T	DIP-8	Tube
MC4558L-G08-T	MC4558G-G08-T	SIP-8	Tube
MC4558L-L09-T	MC4558G-G09-T	SIP-9	Tube
MC4558L-P08-R	MC4558G-P08-R	TSSOP-8	Tape Reel
MC4558L-S08-R	MC4558G-S08-R	SOP-8	Tape Reel
MC4558L-SM1-R	MC4558G-SM1-R	MSOP-8	Tape Reel

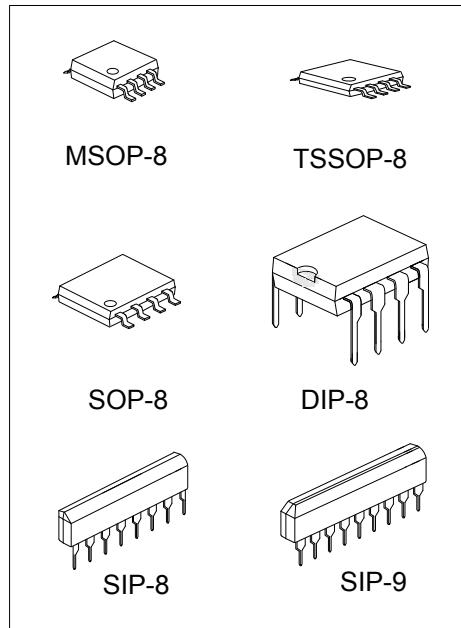

<p>MC4558G-D08-T</p> <p>(1) Packing Type (2) Package Type (3) Green Package</p>	<p>(1) T: Tube, R: Tape Reel (2) D08: DIP-8, G08: SIP-8, G09: SIP-9, P08: TSSOP-8, S08: SOP-8, SM1: MSOP-8 (3) G: Halogen Free and Lead Free, L: Lead Free</p>
---	--

■ MARKING

<p>DIP-8</p> <p>Date Code L: Lead Free G: Halogen Free Lot Code</p>	<p>SOP-8/MSOP-8</p> <p>Date Code L: Lead Free G: Halogen Free Lot Code</p>
<p>TSSOP-8</p> <p>Date Code L: Lead Free G: Halogen Free Lot Code</p>	<p>SIP-8 / SIP-9</p> <p>Date Code L: Lead Free G: Halogen Free Lot Code</p>

## ■ PIN CONFIGURATIONS

SOP-8/DIP-8/MSOP-8/TSSOP-8

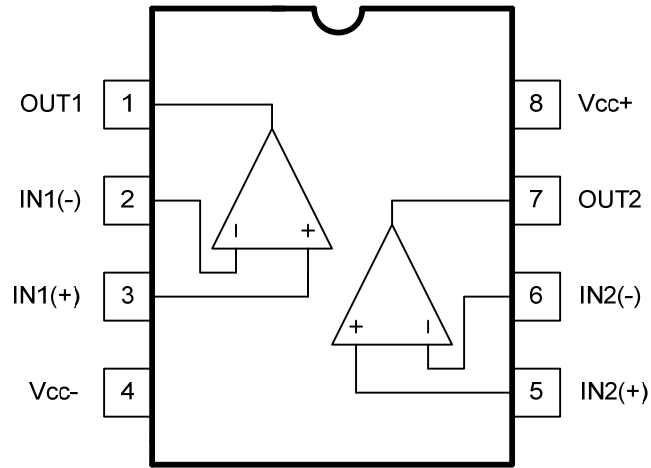

SIP-8

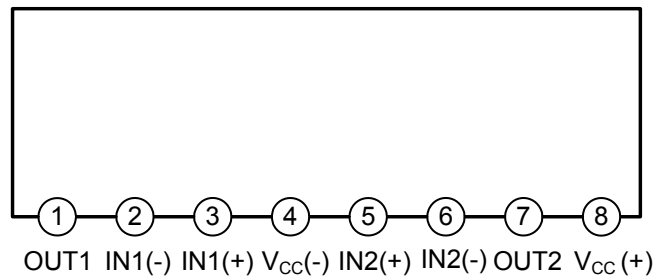

SIP-9

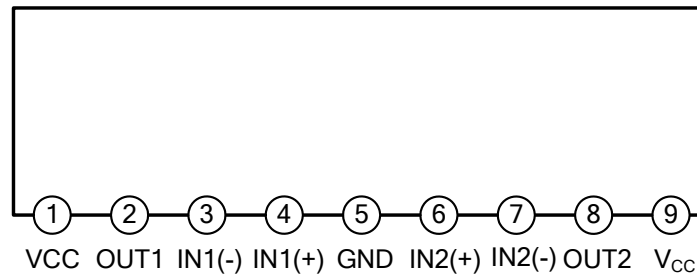

## ■ BLOCK DIAGRAM

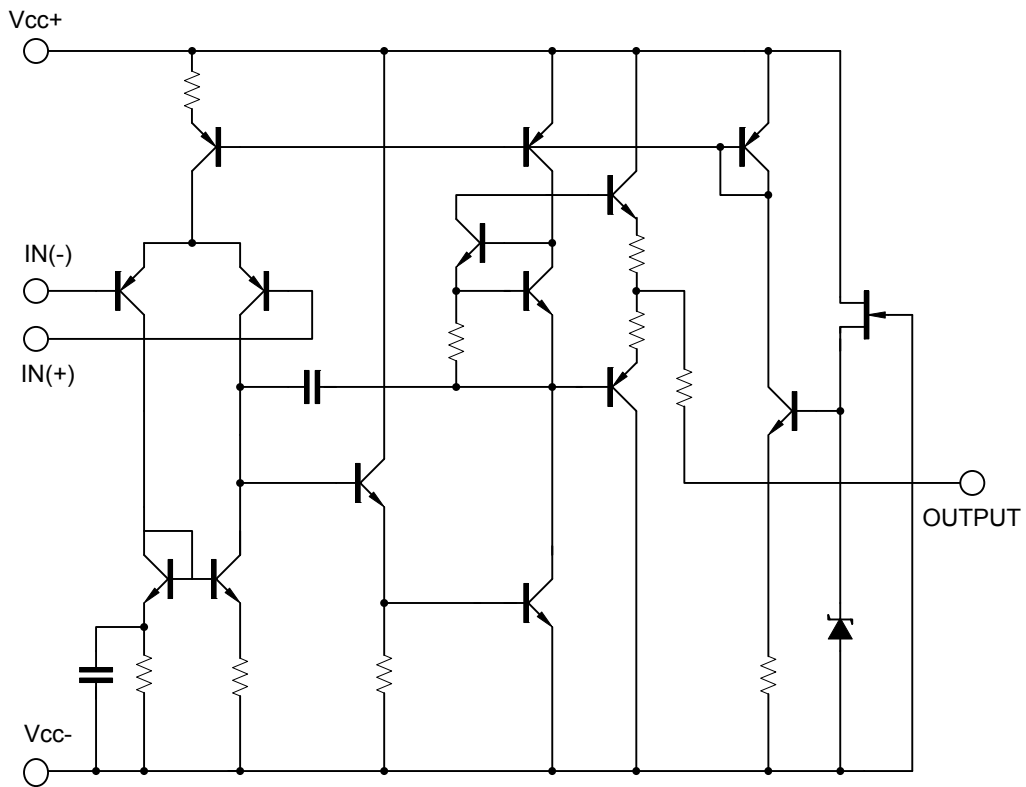

### ■ ABSOLUTE MAXIMUM RATINGS

PARAMETER		SYMBOL	RATING	UNIT
Supply Voltage		$V_{CC}$	$\pm 22$	V
Differential input voltage		$V_{I(DIFF)}$	$\pm 18$	V
Power Dissipation	DIP-8	$P_D$	600	mW
	SOP-8		400	mW
	TSSOP-8		300	mW
	SIP-8		750	mW
	SIP-9			
	MSOP-8		250	mW
Input Voltage		$V_{IN}$	$\pm 15$	V
Junction Temperature		$T_J$	+125	°C
Operating Temperature		$T_{OPR}$	-20 ~ +85	°C
Storage Temperature		$T_{STG}$	-40 ~ +150	°C

Note 1. Absolute maximum ratings are those values beyond which the device could be permanently damaged. Absolute maximum ratings are stress ratings only and functional device operation is not implied.

2. The device is guaranteed to meet performance specification within 0°C ~ +70°C operating temperature range and assured by design from -20°C ~ +85°C.

### ■ ELECTRICAL CHARACTERISTICS ( $T_A=25^\circ\text{C}$ , $V_{CC}=15\text{V}$ , $V_{EE}=-15\text{V}$ )

PARAMETER	SYMBOL	TEST CONDITIONS	MIN	TYP	MAX	UNIT
Supply Current, all Amp, no load	$I_{CC}$			2.3	4.5	mA
Input offset voltage	$V_{I(OFF)}$	$R_S < 10\text{k}\Omega$		2	6	mV
Input offset current	$I_{I(OFF)}$			5	200	nA
Input bias current	$I_{I(BIAS)}$			30	500	nA
Large signal voltage gain	$G_V$	$V_o(p-p) = \pm 10\text{V}$ , $R_L \cong 2\text{k}\Omega$	20	200		V/mV
Common Mode Input Voltage Range	$V_{I(COM)}$		$\pm 12$	$\pm 13$		V
Common Mode Rejection Ratio	$RR_{(COM)}$	$R_S \cong 10\text{k}\Omega$	70	90		dB
Supply Voltage Rejection Ratio	$RR_{(VCC)}$	$R_S \cong 10\text{k}\Omega$	76	90		dB
Output Voltage swing	$V_{O(p-p)}$	$R_L \geq 10\text{k}\Omega$	$\pm 12$	$\pm 14$		V
Power Consumption	$P_C$			70	170	mW
Slew Rate	SR	$V_{IN} = \pm 10\text{V}$ , $R_L \cong 2\text{k}\Omega$ , $C_L \cong 100\text{pF}$	1.2	2.2		V/ $\mu\text{s}$
Rise Time	$T_{RIS}$	$V_{IN} = \pm 20\text{mV}$ , $R_L \cong 2\text{k}\Omega$ , $C_L \cong 100\text{pF}$		0.3		$\mu\text{s}$
Overshoot	OS	$V_{IN} = \pm 20\text{mV}$ , $R_L \cong 2\text{k}\Omega$ , $C_L \cong 100\text{pF}$		15		%
Input Resistance	$R_{IN}$		0.3	2		M $\Omega$
Output Resistance	$R_{OUT}$			75		$\Omega$
Total Harmonic Distortion	THD	$f=1\text{kHz}$ , $A_v=20\text{dB}$ , $R_L=2\text{k}\Omega$ , $V_{OUT}=2\text{Vpp}$ , $C_L=100\text{pF}$		0.008		%
Channel Separation	$V_{O1}/V_{O2}$			120		dB
<b>FREQUENCY CHARACTERISTIC</b>						
Unity Gain Bandwidth	BW		2.0	2.8		MHz

## ■ TYPICAL CHARACTERISTICS

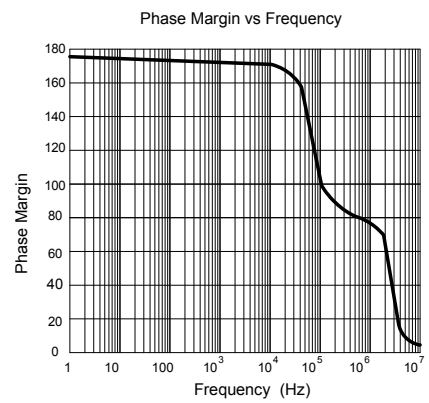
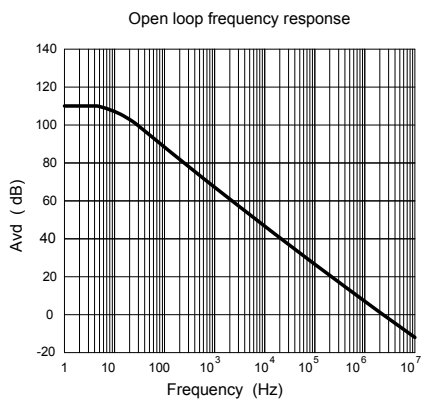
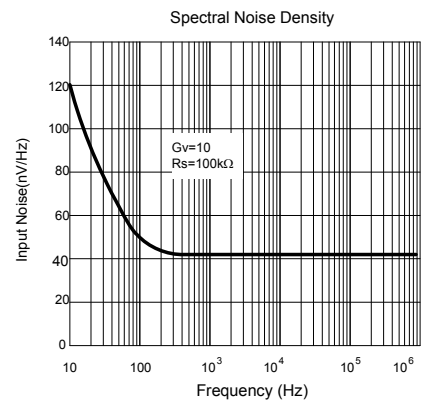
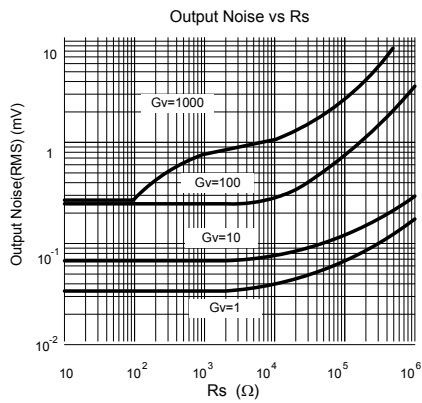
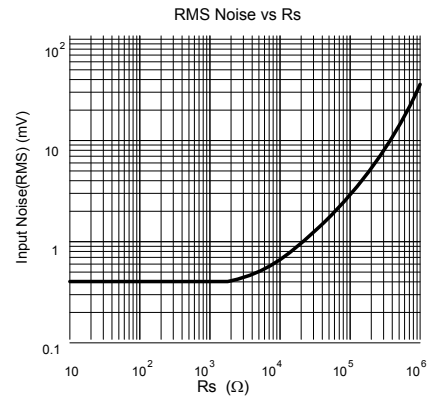
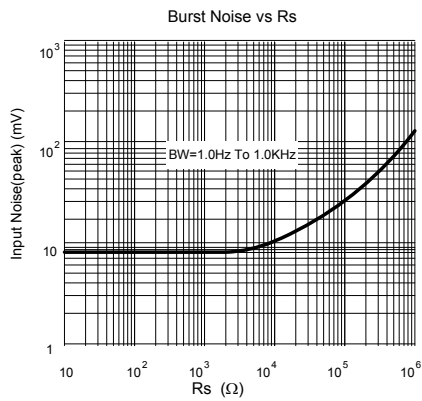

## ■ TYPICAL CHARACTERISTICS(Cont.)

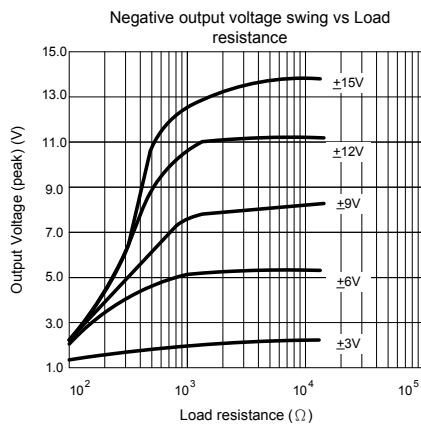
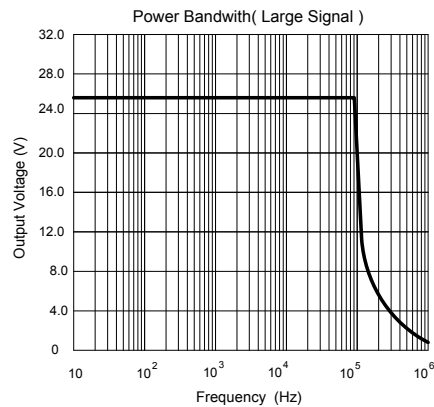
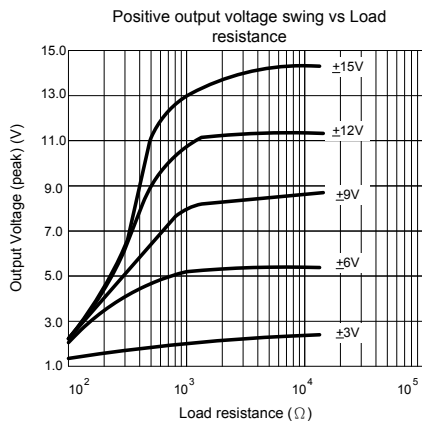

UTC assumes no responsibility for equipment failures that result from using products at values that exceed, even momentarily, rated values (such as maximum ratings, operating condition ranges, or other parameters) listed in products specifications of any and all UTC products described or contained herein. UTC products are not designed for use in life support appliances, devices or systems where malfunction of these products can be reasonably expected to result in personal injury. Reproduction in whole or in part is prohibited without the prior written consent of the copyright owner. UTC reserves the right to make changes to information published in this document, including without limitation specifications and product descriptions, at any time and without notice. This document supersedes and replaces all information supplied prior to the publication hereof.