

## AD8541/AD8542/AD8544

### FEATURES

- Single-supply operation: 2.7 V to 5.5 V**
- Low supply current: 45  $\mu$ A/amplifier**
- Wide bandwidth: 1 MHz**
- No phase reversal**
- Low input currents: 4 pA**
- Unity gain stable**
- Rail-to-rail input and output**
- Qualified for automotive applications**

### APPLICATIONS

- ASIC input or output amplifiers**
- Sensor interfaces**
- Piezoelectric transducer amplifiers**
- Medical instrumentation**
- Mobile communications**
- Audio outputs**
- Portable systems**

### GENERAL DESCRIPTION

The AD8541/AD8542/AD8544 are single, dual, and quad rail-to-rail input and output, single-supply amplifiers featuring very low supply current and 1 MHz bandwidth. All are guaranteed to operate from a 2.7 V single supply as well as a 5 V supply. These parts provide 1 MHz bandwidth at a low current consumption of 45  $\mu$ A per amplifier.

Very low input bias currents enable the AD8541/AD8542/AD8544 to be used for integrators, photodiode amplifiers, piezoelectric sensors, and other applications with high source impedance. The supply current is only 45  $\mu$ A per amplifier, ideal for battery operation.

Rail-to-rail inputs and outputs are useful to designers buffering ASICs in single-supply systems. The AD8541/AD8542/AD8544 are optimized to maintain high gains at lower supply voltages, making them useful for active filters and gain stages.

The AD8541/AD8542/AD8544 are specified over the extended industrial temperature range ( $-40^{\circ}\text{C}$  to  $+125^{\circ}\text{C}$ ). The AD8541 is available in 5-lead SOT-23, 5-lead SC70, and 8-lead SOIC packages. The AD8542 is available in 8-lead SOIC, 8-lead MSOP, and 8-lead TSSOP surface-mount packages. The AD8544 is available in 14-lead narrow SOIC and 14-lead TSSOP surface-mount packages. All MSOP, SC70, and SOT versions are available in tape and reel only. See the Ordering Guide for automotive models.

#### Rev. G

Information furnished by Analog Devices is believed to be accurate and reliable. However, no responsibility is assumed by Analog Devices for its use, nor for any infringements of patents or other rights of third parties that may result from its use. Specifications subject to change without notice. No license is granted by implication or otherwise under any patent or patent rights of Analog Devices. Trademarks and registered trademarks are the property of their respective owners.

### PIN CONFIGURATIONS

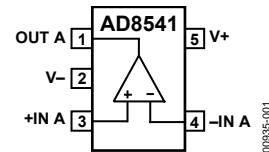

Figure 1. 5-Lead SC70 and 5-Lead SOT-23 (KS and RJ Suffixes)

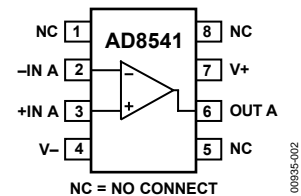

Figure 2. 8-Lead SOIC (R Suffix)



Figure 3. 8-Lead SOIC, 8-Lead MSOP, and 8-Lead TSSOP (R, RM, and RU Suffixes)

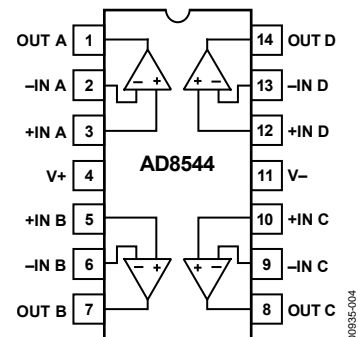

Figure 4. 14-Lead SOIC and 14-Lead TSSOP (R and RU Suffixes)

## TABLE OF CONTENTS

|   |   |                                     |    |
|---|---|-------------------------------------|----|
| Features .....                            | 1 | Theory of Operation .....           | 13 |
| Applications.....                         | 1 | Notes on the AD854x Amplifiers..... | 13 |
| General Description .....                 | 1 | Applications.....                   | 14 |
| Pin Configurations .....                  | 1 | Notch Filter .....                  | 14 |
| Revision History .....                    | 2 | Comparator Function .....           | 14 |
| Specifications.....                       | 3 | Photodiode Application .....        | 15 |
| Electrical Characteristics .....          | 3 | Outline Dimensions .....            | 16 |
| Absolute Maximum Ratings.....             | 6 | Ordering Guide .....                | 19 |
| Thermal Resistance .....                  | 6 | Automotive Products.....            | 19 |
| ESD Caution.....                          | 6 |                                     |    |
| Typical Performance Characteristics ..... | 7 |                                     |    |

## REVISION HISTORY

### 6/11—Rev. F to Rev. G

|  |    |
|--|----|
| Changes to Features Section and General Description Section..... | 1  |
| Changes to Table 5.....  | 6  |
| Updated Outline Dimensions .....                                 | 16 |
| Changes to Ordering Guide .....                                  | 19 |
| Added Automotive Products Section .....                          | 19 |

### 1/08—Rev. E to Rev. F

|  |    |
|--|----|
| Inserted Figure 21; Renumbered Sequentially.....                           | 9  |
| Changes to Figure 22 Caption.....  | 9  |
| Changes to Notch Filter Section, Figure 35, Figure 36, and Figure 37 ..... | 13 |
| Updated Outline Dimensions .....   | 16 |

### 1/07—Rev. D to Rev. E

|   |           |
|---|-----------|
| Updated Format.....                             | Universal |
| Changes to Photodiode Application Section ..... | 14        |
| Changes to Ordering Guide .....                 | 17        |

### 8/04—Rev. C to Rev. D

|                                  |    |
|----------------------------------|----|
| Changes to Ordering Guide .....  | 5  |
| Changes to Figure 3.....         | 10 |
| Updated Outline Dimensions ..... | 12 |

### 1/03—Rev. B to Rev. C

|                                      |           |
|--------------------------------------|-----------|
| Updated Format.....                  | Universal |
| Changes to General Description ..... | 1         |
| Changes to Ordering Guide .....      | 5         |
| Changes to Outline Dimensions .....  | 12        |

# SPECIFICATIONS

## ELECTRICAL CHARACTERISTICS

$V_S = 2.7\text{ V}$ ,  $V_{CM} = 1.35\text{ V}$ ,  $T_A = 25^\circ\text{C}$ , unless otherwise noted.

Table 1.

| Parameter                     | Symbol                   | Conditions  | Min   | Typ      | Max  | Unit                         |
|-------------------------------|--------------------------|---|-------|----------|------|------------------------------|
| <b>INPUT CHARACTERISTICS</b>  |                          |   |       |          |      |                              |
| Offset Voltage                | $V_{OS}$                 | $-40^\circ\text{C} \leq T_A \leq +125^\circ\text{C}$  |       | 1        | 6    | mV                           |
| Input Bias Current            | $I_B$                    | $-40^\circ\text{C} \leq T_A \leq +85^\circ\text{C}$   |       | 4        | 60   | pA                           |
|                               |                          | $-40^\circ\text{C} \leq T_A \leq +125^\circ\text{C}$  |       |          | 100  | pA                           |
| Input Offset Current          | $I_{OS}$                 | $-40^\circ\text{C} \leq T_A \leq +125^\circ\text{C}$  |       |          | 1000 | pA                           |
|                               |                          | $-40^\circ\text{C} \leq T_A \leq +85^\circ\text{C}$   |       | 0.1      | 30   | pA                           |
|                               |                          | $-40^\circ\text{C} \leq T_A \leq +125^\circ\text{C}$  |       |          |      | 50                           |
| Input Voltage Range           |                          |   | 0     |          | 2.7  | V                            |
| Common-Mode Rejection Ratio   | CMRR                     | $V_{CM} = 0\text{ V to } 2.7\text{ V}$<br>$-40^\circ\text{C} \leq T_A \leq +125^\circ\text{C}$                            | 40    | 45       |      | dB                           |
| Large Signal Voltage Gain     | $A_{VO}$                 | $R_L = 100\text{ k}\Omega$ , $V_O = 0.5\text{ V to } 2.2\text{ V}$<br>$-40^\circ\text{C} \leq T_A \leq +85^\circ\text{C}$ | 38    |          |      | dB                           |
|                               |                          | $-40^\circ\text{C} \leq T_A \leq +125^\circ\text{C}$  | 100   | 500      |      | V/mV                         |
|                               |                          | $-40^\circ\text{C} \leq T_A \leq +125^\circ\text{C}$  | 50    |          |      | V/mV                         |
| Offset Voltage Drift          | $\Delta V_{OS}/\Delta T$ | $-40^\circ\text{C} \leq T_A \leq +125^\circ\text{C}$  |       | 4        |      | $\mu\text{V}/^\circ\text{C}$ |
| Bias Current Drift            | $\Delta I_B/\Delta T$    | $-40^\circ\text{C} \leq T_A \leq +85^\circ\text{C}$   |       | 100      |      | fA/ $^\circ\text{C}$         |
| Offset Current Drift          | $\Delta I_{OS}/\Delta T$ | $-40^\circ\text{C} \leq T_A \leq +125^\circ\text{C}$  |       | 2000     |      | fA/ $^\circ\text{C}$         |
|                               |                          | $-40^\circ\text{C} \leq T_A \leq +125^\circ\text{C}$  |       | 25       |      | fA/ $^\circ\text{C}$         |
| <b>OUTPUT CHARACTERISTICS</b> |                          |   |       |          |      |                              |
| Output Voltage High           | $V_{OH}$                 | $I_L = 1\text{ mA}$<br>$-40^\circ\text{C} \leq T_A \leq +125^\circ\text{C}$   | 2.575 | 2.65     |      | V                            |
| Output Voltage Low            | $V_{OL}$                 | $I_L = 1\text{ mA}$<br>$-40^\circ\text{C} \leq T_A \leq +125^\circ\text{C}$   | 2.550 |          |      | V                            |
|                               |                          | $-40^\circ\text{C} \leq T_A \leq +125^\circ\text{C}$  |       | 35       | 100  | mV                           |
| Output Current                | $I_{OUT}$                | $V_{OUT} = V_S - 1\text{ V}$  |       | 15       |      | mA                           |
|                               | $I_{SC}$                 |   |       | $\pm 20$ |      | mA                           |
| Closed-Loop Output Impedance  | $Z_{OUT}$                | $f = 200\text{ kHz}$ , $A_V = 1$  |       | 50       |      | $\Omega$                     |
| <b>POWER SUPPLY</b>           |                          |   |       |          |      |                              |
| Power Supply Rejection Ratio  | PSRR                     | $V_S = 2.5\text{ V to } 6\text{ V}$<br>$-40^\circ\text{C} \leq T_A \leq +125^\circ\text{C}$                               | 65    | 76       |      | dB                           |
| Supply Current/Amplifier      | $I_{SY}$                 | $V_O = 0\text{ V}$<br>$-40^\circ\text{C} \leq T_A \leq +125^\circ\text{C}$  | 60    |          |      | dB                           |
|                               |                          | $-40^\circ\text{C} \leq T_A \leq +125^\circ\text{C}$  |       | 38       | 55   | $\mu\text{A}$                |
|                               |                          |   |       |          | 75   | $\mu\text{A}$                |
| <b>DYNAMIC PERFORMANCE</b>    |                          |   |       |          |      |                              |
| Slew Rate                     | SR                       | $R_L = 100\text{ k}\Omega$  | 0.4   | 0.75     |      | V/ $\mu\text{s}$             |
| Settling Time                 | $t_s$                    | To 0.1% (1 V step)  |       | 5        |      | $\mu\text{s}$                |
| Gain Bandwidth Product        | GBP                      |   |       | 980      |      | kHz                          |
| Phase Margin                  | $\Phi_M$                 |   |       | 63       |      | Degrees                      |
| <b>NOISE PERFORMANCE</b>      |                          |   |       |          |      |                              |
| Voltage Noise Density         | $e_n$                    | $f = 1\text{ kHz}$  |       | 40       |      | nV/ $\sqrt{\text{Hz}}$       |
|                               |                          | $f = 10\text{ kHz}$   |       | 38       |      | nV/ $\sqrt{\text{Hz}}$       |
| Current Noise Density         | $i_n$                    |   |       | <0.1     |      | pA/ $\sqrt{\text{Hz}}$       |

# AD8541/AD8542/AD8544

$V_S = 3.0\text{ V}$ ,  $V_{CM} = 1.5\text{ V}$ ,  $T_A = 25^\circ\text{C}$ , unless otherwise noted.

**Table 2.**

| Parameter                     | Symbol                      | Conditions   | Min   | Typ      | Max  | Unit                         |
|-------------------------------|-----------------------------|--|-------|----------|------|------------------------------|
| <b>INPUT CHARACTERISTICS</b>  |                             |  |       |          |      |                              |
| Offset Voltage                | $V_{OS}$                    | $-40^\circ\text{C} \leq T_A \leq +125^\circ\text{C}$   |       | 1        | 6    | mV                           |
| Input Bias Current            | $I_B$                       | $-40^\circ\text{C} \leq T_A \leq +125^\circ\text{C}$   |       | 4        | 7    | pA                           |
| Input Offset Current          | $I_{OS}$                    | $-40^\circ\text{C} \leq T_A \leq +85^\circ\text{C}$  |       |          | 100  | pA                           |
|                               |                             | $-40^\circ\text{C} \leq T_A \leq +125^\circ\text{C}$   |       | 0.1      | 1000 | pA                           |
| Input Voltage Range           | Common-Mode Rejection Ratio | $V_{CM} = 0\text{ V to }3\text{ V}$<br>$-40^\circ\text{C} \leq T_A \leq +125^\circ\text{C}$  | 0     |          | 3    | V                            |
|                               |                             |  | 40    | 45       |      | dB                           |
| Large Signal Voltage Gain     | $A_{VO}$                    | $R_L = 100\text{ k}\Omega$ , $V_O = 0.5\text{ V to }2.2\text{ V}$<br>$-40^\circ\text{C} \leq T_A \leq +85^\circ\text{C}$<br>$-40^\circ\text{C} \leq T_A \leq +125^\circ\text{C}$ | 38    |          |      | dB                           |
|                               |                             |  | 100   | 500      |      | V/mV                         |
| Offset Voltage Drift          | $\Delta V_{OS}/\Delta T$    | $-40^\circ\text{C} \leq T_A \leq +125^\circ\text{C}$   |       | 50       |      | V/mV                         |
| Bias Current Drift            | $\Delta I_B/\Delta T$       | $-40^\circ\text{C} \leq T_A \leq +85^\circ\text{C}$  |       | 2        |      | V/mV                         |
| Offset Current Drift          | $\Delta I_{OS}/\Delta T$    | $-40^\circ\text{C} \leq T_A \leq +125^\circ\text{C}$   |       | 4        |      | $\mu\text{V}/^\circ\text{C}$ |
|                               |                             | $-40^\circ\text{C} \leq T_A \leq +125^\circ\text{C}$   |       | 100      |      | $\text{fA}/^\circ\text{C}$   |
| <b>OUTPUT CHARACTERISTICS</b> |                             |  |       |          |      |                              |
| Output Voltage High           | $V_{OH}$                    | $I_L = 1\text{ mA}$<br>$-40^\circ\text{C} \leq T_A \leq +125^\circ\text{C}$  | 2.875 | 2.955    |      | V                            |
| Output Voltage Low            | $V_{OL}$                    | $I_L = 1\text{ mA}$<br>$-40^\circ\text{C} \leq T_A \leq +125^\circ\text{C}$  | 2.850 |          | 100  | V                            |
| Output Current                | $I_{OUT}$                   | $V_{OUT} = V_S - 1\text{ V}$   |       | 18       | 125  | mV                           |
|                               | $I_{SC}$                    |  |       | $\pm 25$ |      | mV                           |
| Closed-Loop Output Impedance  | $Z_{OUT}$                   | $f = 200\text{ kHz}$ , $A_V = 1$   |       | 50       |      | $\Omega$                     |
| <b>POWER SUPPLY</b>           |                             |  |       |          |      |                              |
| Power Supply Rejection Ratio  | PSRR                        | $V_S = 2.5\text{ V to }6\text{ V}$<br>$-40^\circ\text{C} \leq T_A \leq +125^\circ\text{C}$   | 65    | 76       |      | dB                           |
| Supply Current/Amplifier      | $I_{SY}$                    | $V_O = 0\text{ V}$<br>$-40^\circ\text{C} \leq T_A \leq +125^\circ\text{C}$   | 60    |          |      | dB                           |
|                               |                             |  |       | 40       | 60   | $\mu\text{A}$                |
| <b>DYNAMIC PERFORMANCE</b>    |                             |  |       |          |      |                              |
| Slew Rate                     | SR                          | $R_L = 100\text{ k}\Omega$   | 0.4   | 0.8      |      | $\text{V}/\mu\text{s}$       |
| Settling Time                 | $t_s$                       | To 0.01% (1 V step)  |       | 5        |      | $\mu\text{s}$                |
| Gain Bandwidth Product        | GBP                         |  |       | 980      |      | kHz                          |
| Phase Margin                  | $\Phi_M$                    |  |       | 64       |      | Degrees                      |
| <b>NOISE PERFORMANCE</b>      |                             |  |       |          |      |                              |
| Voltage Noise Density         | $e_n$                       | $f = 1\text{ kHz}$   |       | 42       |      | $\text{nV}/\sqrt{\text{Hz}}$ |
|                               |                             | $f = 10\text{ kHz}$  |       | 38       |      | $\text{nV}/\sqrt{\text{Hz}}$ |
| Current Noise Density         | $i_n$                       |  |       | <0.1     |      | $\text{pA}/\sqrt{\text{Hz}}$ |

$V_S = 5.0\text{ V}$ ,  $V_{CM} = 2.5\text{ V}$ ,  $T_A = 25^\circ\text{C}$ , unless otherwise noted.

Table 3.

| Parameter                     | Symbol                   | Conditions   | Min   | Typ      | Max | Unit                         |
|-------------------------------|--------------------------|--|-------|----------|-----|------------------------------|
| <b>INPUT CHARACTERISTICS</b>  |                          |  |       |          |     |                              |
| Offset Voltage                | $V_{OS}$                 | $-40^\circ\text{C} \leq T_A \leq +125^\circ\text{C}$               |       | 1        | 6   | mV                           |
| Input Bias Current            | $I_B$                    | $-40^\circ\text{C} \leq T_A \leq +85^\circ\text{C}$                |       | 4        | 60  | pA                           |
|                               |                          | $-40^\circ\text{C} \leq T_A \leq +125^\circ\text{C}$               |       |          | 100 | pA                           |
| Input Offset Current          | $I_{OS}$                 | $-40^\circ\text{C} \leq T_A \leq +85^\circ\text{C}$                |       | 0.1      | 30  | pA                           |
|                               |                          | $-40^\circ\text{C} \leq T_A \leq +125^\circ\text{C}$               |       |          | 50  | pA                           |
|                               |                          | $-40^\circ\text{C} \leq T_A \leq +125^\circ\text{C}$               |       |          | 500 | pA                           |
| Input Voltage Range           |                          |  | 0     |          | 5   | V                            |
| Common-Mode Rejection Ratio   | CMRR                     | $V_{CM} = 0\text{ V to } 5\text{ V}$                               | 40    | 48       |     | dB                           |
|                               |                          | $-40^\circ\text{C} \leq T_A \leq +125^\circ\text{C}$               | 38    |          |     | dB                           |
| Large Signal Voltage Gain     | $A_{VO}$                 | $R_L = 100\text{ k}\Omega$ , $V_O = 0.5\text{ V to } 2.2\text{ V}$ | 20    | 40       |     | V/mV                         |
|                               |                          | $-40^\circ\text{C} \leq T_A \leq +85^\circ\text{C}$                | 10    |          |     | V/mV                         |
|                               |                          | $-40^\circ\text{C} \leq T_A \leq +125^\circ\text{C}$               | 2     |          |     | V/mV                         |
| Offset Voltage Drift          | $\Delta V_{OS}/\Delta T$ | $-40^\circ\text{C} \leq T_A \leq +125^\circ\text{C}$               |       | 4        |     | $\mu\text{V}/^\circ\text{C}$ |
| Bias Current Drift            | $\Delta I_B/\Delta T$    | $-40^\circ\text{C} \leq T_A \leq +85^\circ\text{C}$                |       | 100      |     | fA/°C                        |
|                               |                          | $-40^\circ\text{C} \leq T_A \leq +125^\circ\text{C}$               |       | 2000     |     | fA/°C                        |
| Offset Current Drift          | $\Delta I_{OS}/\Delta T$ | $-40^\circ\text{C} \leq T_A \leq +125^\circ\text{C}$               |       | 25       |     | fA/°C                        |
| <b>OUTPUT CHARACTERISTICS</b> |                          |  |       |          |     |                              |
| Output Voltage High           | $V_{OH}$                 | $I_L = 1\text{ mA}$  | 4.9   | 4.965    |     | V                            |
|                               |                          | $-40^\circ\text{C} \leq T_A \leq +125^\circ\text{C}$               | 4.875 |          |     | V                            |
| Output Voltage Low            | $V_{OL}$                 | $I_L = 1\text{ mA}$  |       | 25       | 100 | mV                           |
|                               |                          | $-40^\circ\text{C} \leq T_A \leq +125^\circ\text{C}$               |       |          | 125 | mV                           |
| Output Current                | $I_{OUT}$                | $V_{OUT} = V_S - 1\text{ V}$                                       |       | 30       |     | mA                           |
|                               | $I_{SC}$                 |  |       | $\pm 60$ |     | mA                           |
| Closed-Loop Output Impedance  | $Z_{OUT}$                | $f = 200\text{ kHz}$ , $A_V = 1$                                   |       | 45       |     | $\Omega$                     |
| <b>POWER SUPPLY</b>           |                          |  |       |          |     |                              |
| Power Supply Rejection Ratio  | PSRR                     | $V_S = 2.5\text{ V to } 6\text{ V}$                                | 65    | 76       |     | dB                           |
|                               |                          | $-40^\circ\text{C} \leq T_A \leq +125^\circ\text{C}$               | 60    |          |     | dB                           |
| Supply Current/Amplifier      | $I_{SY}$                 | $V_O = 0\text{ V}$   |       | 45       | 65  | $\mu\text{A}$                |
|                               |                          | $-40^\circ\text{C} \leq T_A \leq +125^\circ\text{C}$               |       |          | 85  | $\mu\text{A}$                |
| <b>DYNAMIC PERFORMANCE</b>    |                          |  |       |          |     |                              |
| Slew Rate                     | SR                       | $R_L = 100\text{ k}\Omega$ , $C_L = 200\text{ pF}$                 | 0.45  | 0.92     |     | V/ $\mu\text{s}$             |
| Full Power Bandwidth          | $BW_P$                   | 1% distortion  |       | 70       |     | kHz                          |
| Settling Time                 | $t_S$                    | To 0.1% (1 V step)   |       | 6        |     | $\mu\text{s}$                |
| Gain Bandwidth Product        | GBP                      |  |       | 1000     |     | kHz                          |
| Phase Margin                  | $\Phi_M$                 |  |       | 67       |     | Degrees                      |
| <b>NOISE PERFORMANCE</b>      |                          |  |       |          |     |                              |
| Voltage Noise Density         | $e_n$                    | $f = 1\text{ kHz}$   |       | 42       |     | nV/ $\sqrt{\text{Hz}}$       |
|                               | $e_n$                    | $f = 10\text{ kHz}$  |       | 38       |     | nV/ $\sqrt{\text{Hz}}$       |
| Current Noise Density         | $i_n$                    |  |       | <0.1     |     | pA/ $\sqrt{\text{Hz}}$       |

## ABSOLUTE MAXIMUM RATINGS

Table 4.

| Parameter                               | Rating                                      |
|---|---|
| Supply Voltage ( $V_s$ )                | 6 V   |
| Input Voltage                           | GND to $V_s$                                |
| Differential Input Voltage <sup>1</sup> | $\pm 6$ V                                   |
| Storage Temperature Range               | $-65^\circ\text{C}$ to $+150^\circ\text{C}$ |
| Operating Temperature Range             | $-40^\circ\text{C}$ to $+125^\circ\text{C}$ |
| Junction Temperature Range              | $-65^\circ\text{C}$ to $+150^\circ\text{C}$ |
| Lead Temperature (Soldering, 60 sec)    | $300^\circ\text{C}$                         |

<sup>1</sup> For supplies less than 6 V, the differential input voltage is equal to  $\pm V_s$ .

Stresses above those listed under Absolute Maximum Ratings may cause permanent damage to the device. This is a stress rating only; functional operation of the device at these or any other conditions above those indicated in the operational section of this specification is not implied. Exposure to absolute maximum rating conditions for extended periods may affect device reliability.

## THERMAL RESISTANCE

$\theta_{JA}$  is specified for the worst-case conditions, that is, a device soldered in a circuit board for surface-mount packages and measured using a standard 4-layer board, unless otherwise specified.

Table 5.

| Package Type       | $\theta_{JA}$ | $\theta_{JC}$ | Unit                      |
|--------------------|---------------|---------------|---------------------------|
| 5-Lead SC70 (KS)   | 376           | 126           | $^\circ\text{C}/\text{W}$ |
| 5-Lead SOT-23 (RJ) | 190           | 92            | $^\circ\text{C}/\text{W}$ |
| 8-Lead SOIC (R)    | 120           | 45            | $^\circ\text{C}/\text{W}$ |
| 8-Lead MSOP (RM)   | 142           | 45            | $^\circ\text{C}/\text{W}$ |
| 8-Lead TSSOP (RU)  | 240           | 43            | $^\circ\text{C}/\text{W}$ |
| 14-Lead SOIC (R)   | 115           | 36            | $^\circ\text{C}/\text{W}$ |
| 14-Lead TSSOP (RU) | 112           | 35            | $^\circ\text{C}/\text{W}$ |

## ESD CAUTION



**ESD (electrostatic discharge) sensitive device.** Charged devices and circuit boards can discharge without detection. Although this product features patented or proprietary protection circuitry, damage may occur on devices subjected to high energy ESD. Therefore, proper ESD precautions should be taken to avoid performance degradation or loss of functionality.

# TYPICAL PERFORMANCE CHARACTERISTICS

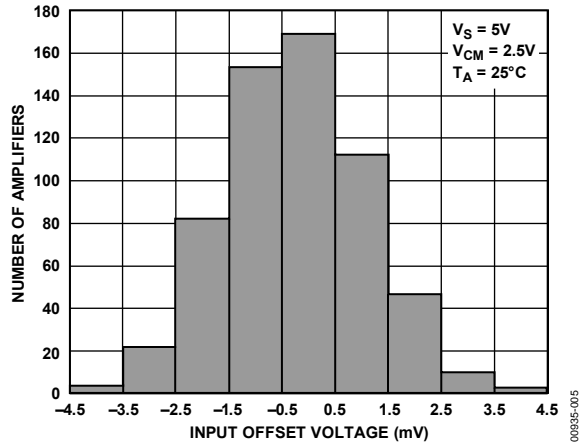

Figure 5. Input Offset Voltage Distribution

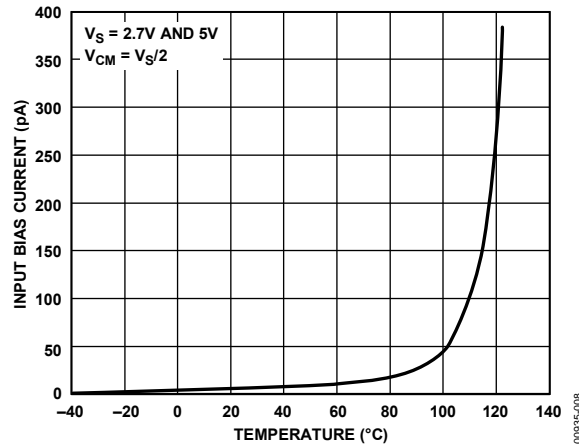

Figure 8. Input Bias Current vs. Temperature

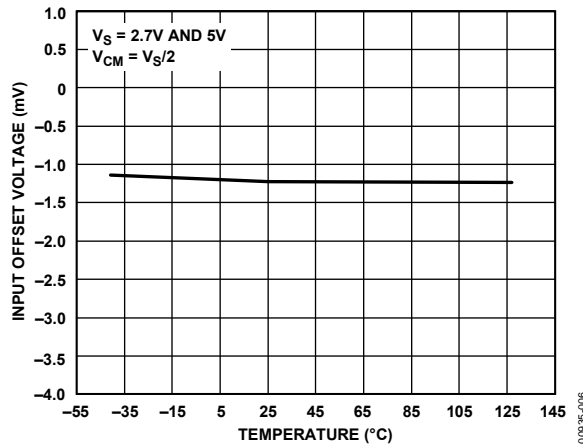

Figure 6. Input Offset Voltage vs. Temperature

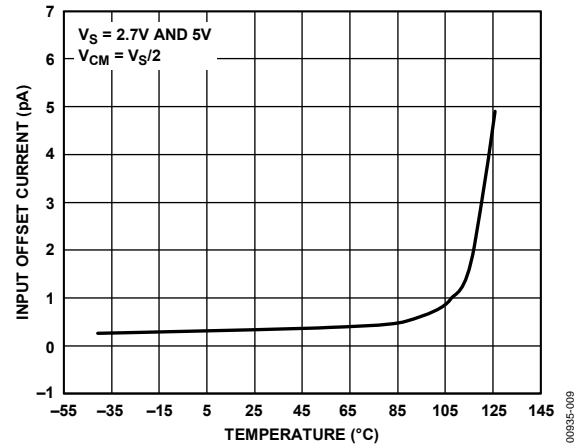

Figure 9. Input Offset Current vs. Temperature

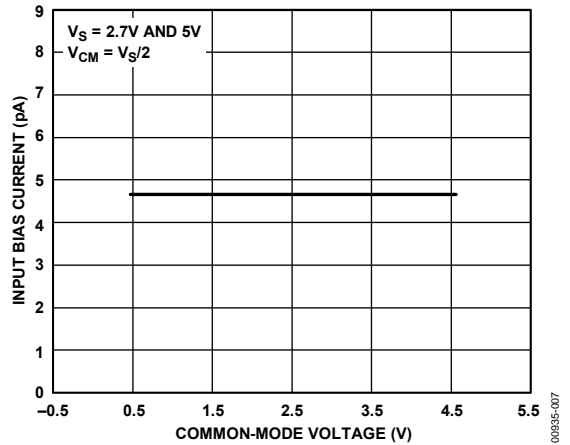

Figure 7. Input Bias Current vs. Common-Mode Voltage

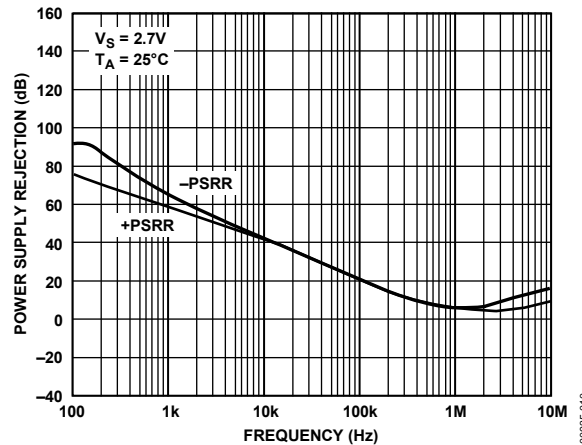

Figure 10. Power Supply Rejection vs. Frequency

# AD8541/AD8542/AD8544



Figure 11. Output Voltage to Supply Rail vs. Load Current



Figure 14. Small Signal Overshoot vs. Load Capacitance



Figure 12. Closed-Loop Output Voltage Swing vs. Frequency



Figure 15. Small Signal Overshoot vs. Load Capacitance



Figure 13. Small Signal Overshoot vs. Load Capacitance

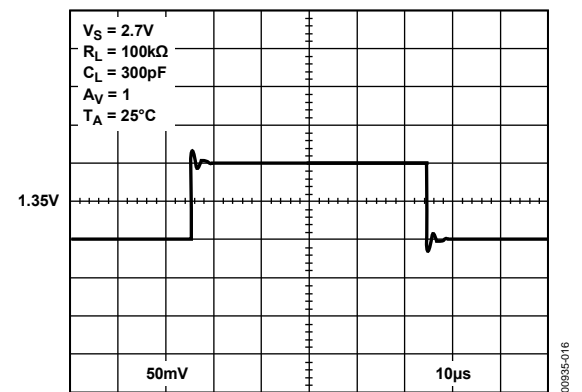

Figure 16. Small Signal Transient Response





Figure 17. Large Signal Transient Response

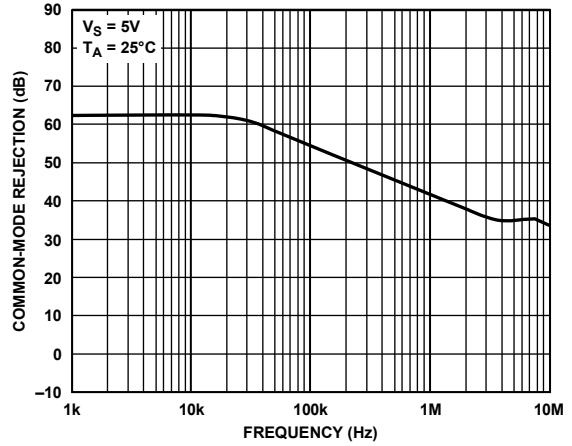

Figure 20. Common-Mode Rejection vs. Frequency



Figure 18. Open-Loop Gain and Phase vs. Frequency

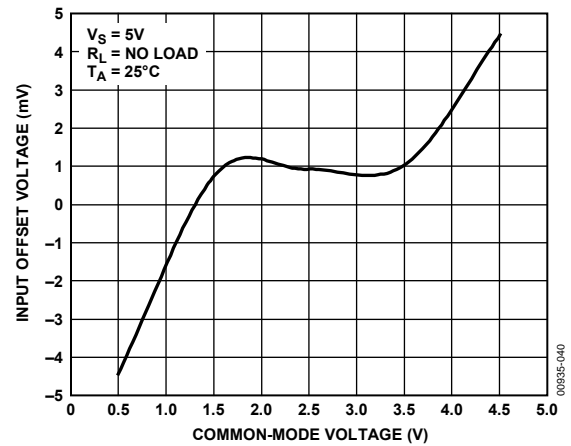

Figure 21. Input Offset Voltage vs. Common-Mode Voltage



Figure 19. Power Supply Rejection Ratio vs. Frequency

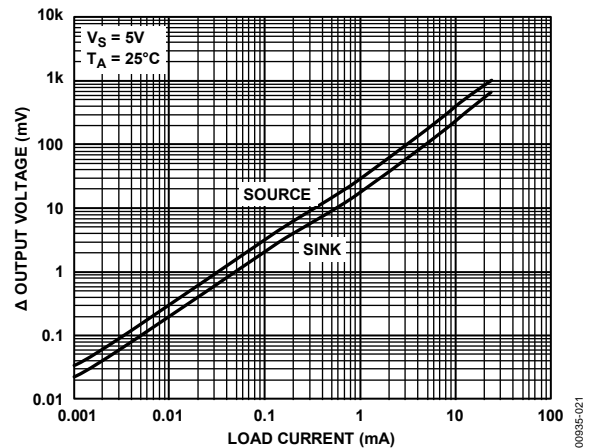

Figure 22. Output Voltage to Supply Rail vs. Load Current

# AD8541/AD8542/AD8544

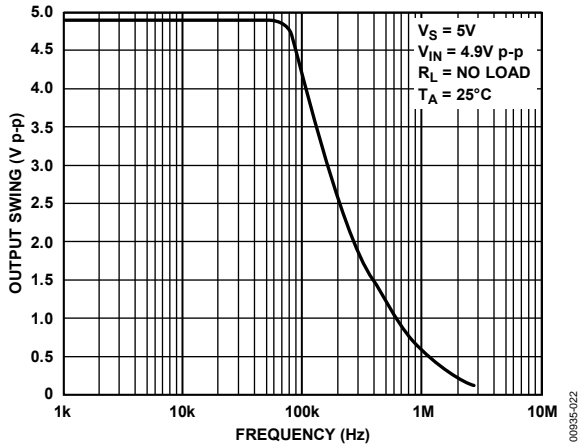

Figure 23. Closed-Loop Output Voltage Swing vs. Frequency,

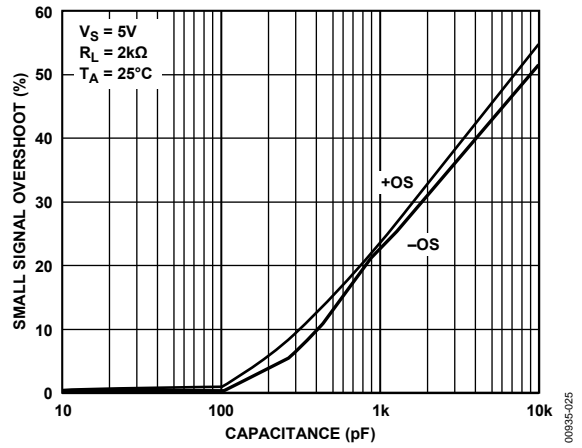

Figure 26. Small Signal Overshoot vs. Load Capacitance

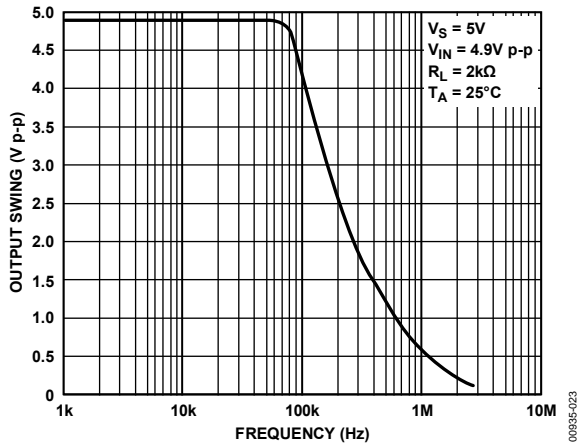

Figure 24. Closed-Loop Output Voltage Swing vs. Frequency

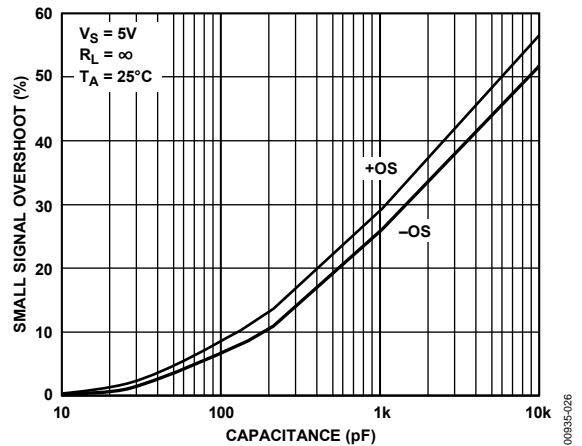

Figure 27. Small Signal Overshoot vs. Load Capacitance

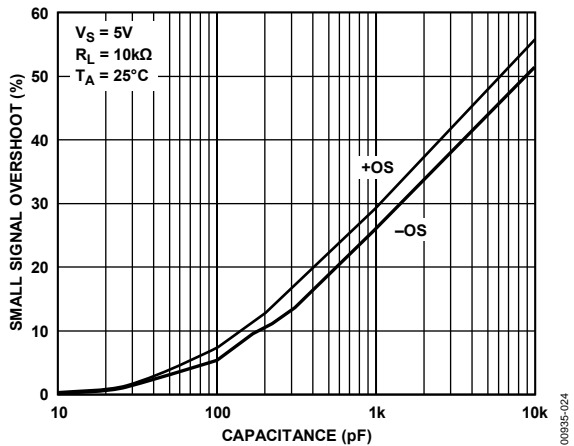

Figure 25. Small Signal Overshoot vs. Load Capacitance

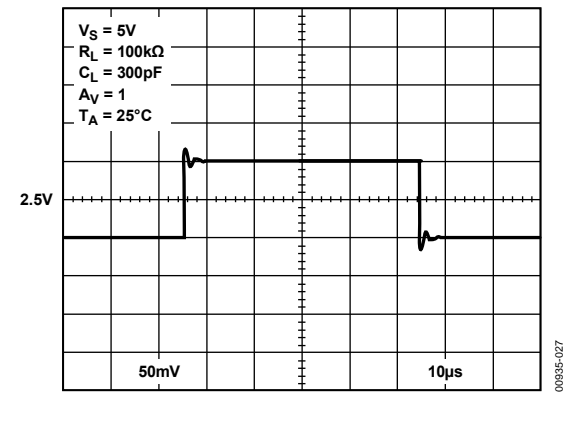

Figure 28. Small Signal Transient Response



Figure 29. Large Signal Transient Response

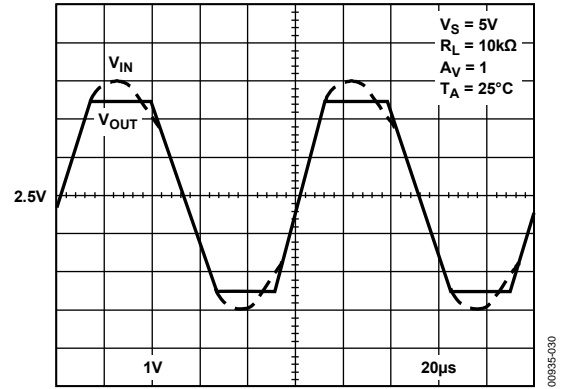

Figure 31. No Phase Reversal

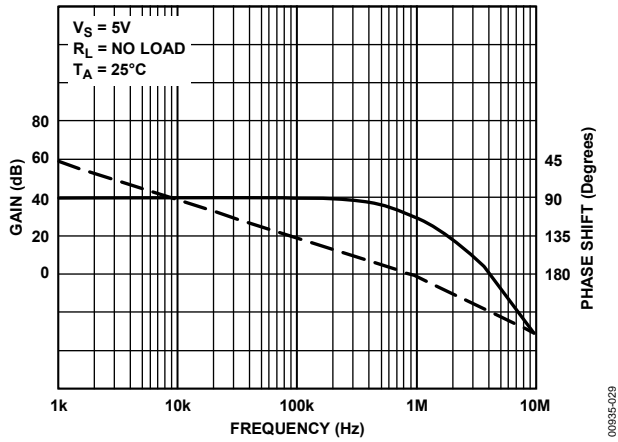

Figure 30. Open-Loop Gain and Phase vs. Frequency

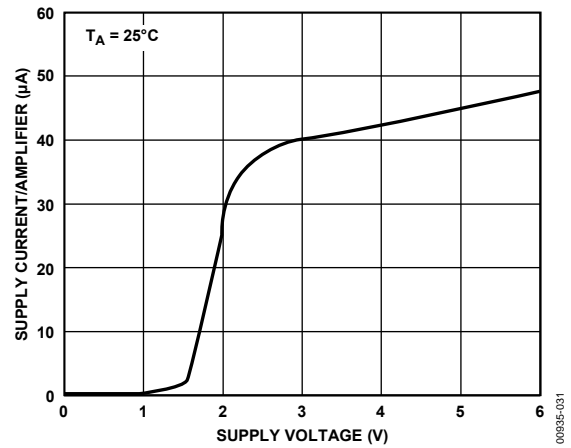

Figure 32. Supply Current per Amplifier vs. Supply Voltage

# AD8541/AD8542/AD8544

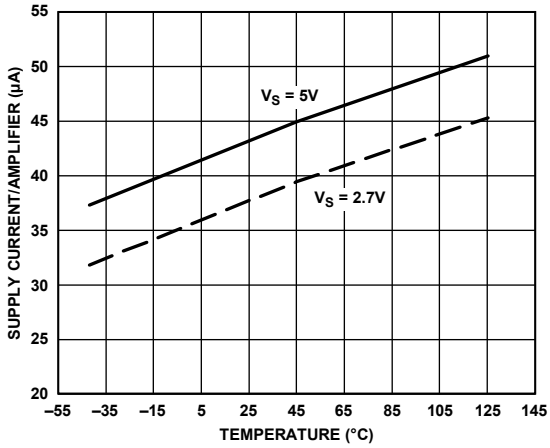

Figure 33. Supply Current per Amplifier vs. Temperature

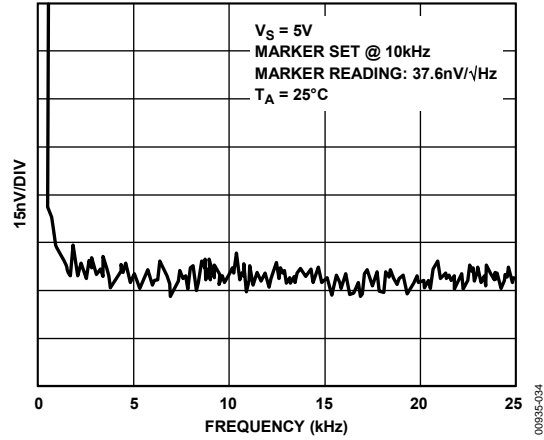

Figure 35. Voltage Noise

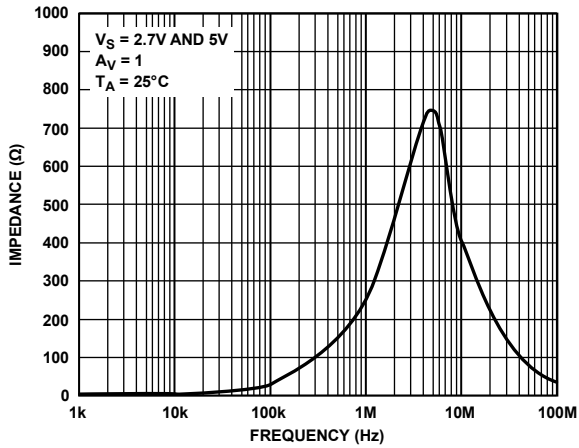

Figure 34. Closed-Loop Output Impedance vs. Frequency

## THEORY OF OPERATION

### NOTES ON THE AD854X AMPLIFIERS

The AD8541/AD8542/AD8544 amplifiers are improved performance, general-purpose operational amplifiers. Performance has been improved over previous amplifiers in several ways, including lower supply current for 1 MHz gain bandwidth, higher output current, and better performance at lower voltages.

#### **Lower Supply Current for 1 MHz Gain Bandwidth**

The AD854x series typically uses 45  $\mu\text{A}$  of current per amplifier, which is much less than the 200  $\mu\text{A}$  to 700  $\mu\text{A}$  used in earlier generation parts with similar performance. This makes the AD854x series a good choice for upgrading portable designs for longer battery life. Alternatively, additional functions and performance can be added at the same current drain.

#### **Higher Output Current**

At 5 V single supply, the short-circuit current is typically 60  $\mu\text{A}$ . Even 1 V from the supply rail, the AD854x amplifiers can provide a 30 mA output current, sourcing, or sinking.

Sourcing and sinking are strong at lower voltages, with 15 mA available at 2.7 V and 18 mA at 3.0 V. For even higher output currents, see the [AD8531/AD8532/AD8534](#) parts for output currents to 250 mA. Information on these parts is available from your Analog Devices, Inc. representative, and data sheets are available at [www.analog.com](http://www.analog.com).

#### **Better Performance at Lower Voltages**

The AD854x family of parts was designed to provide better ac performance at 3.0 V and 2.7 V than previously available parts. Typical gain bandwidth product is close to 1 MHz at 2.7 V. Voltage gain at 2.7 V and 3.0 V is typically 500,000. Phase margin is typically over 60°C, making the part easy to use.

## APPLICATIONS

### NOTCH FILTER

The AD854x have very high open-loop gain (especially with a supply voltage below 4 V), which makes it useful for active filters of all types. For example, Figure 36 illustrates the AD8542 in the classic twin-T notch filter design. The twin-T notch is desired for simplicity, low output impedance, and minimal use of op amps. In fact, this notch filter can be designed with only one op amp if Q adjustment is not required. Simply remove U2 as illustrated in Figure 37. However, a major drawback to this circuit topology is ensuring that all the Rs and Cs closely match. The components must closely match or notch frequency offset and drift causes the circuit to no longer attenuate at the ideal notch frequency. To achieve desired performance, 1% or better component tolerances or special component screens are usually required. One method to desensitize the circuit-to-component mismatch is to increase R2 with respect to R1, which lowers Q. A lower Q increases attenuation over a wider frequency range but reduces attenuation at the peak notch frequency.



Figure 36. 60 Hz Twin-T Notch Filter, Q = 10

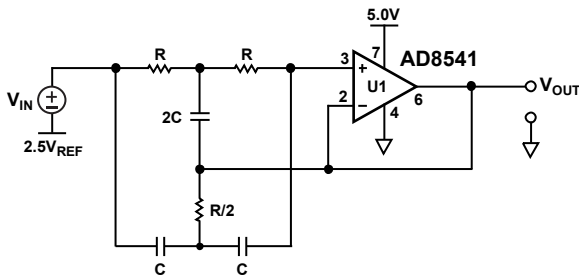

Figure 37. 60 Hz Twin-T Notch Filter, Q = ∞ (Ideal)

Figure 38 is an example of the AD8544 in a notch filter circuit. The frequency dependent negative resistance (FDNR) notch filter has fewer critical matching requirements than the twin-T notch, where as the Q of the FDNR is directly proportional to a single resistor R1. Although matching component values is still important, it is also much easier and/or less expensive to accomplish in the FDNR circuit. For example, the twin-T notch uses three capacitors with two unique values, whereas the FDNR circuit uses only two capacitors, which may be of the same value. U3 is simply a buffer that is added to lower the output impedance of the circuit.

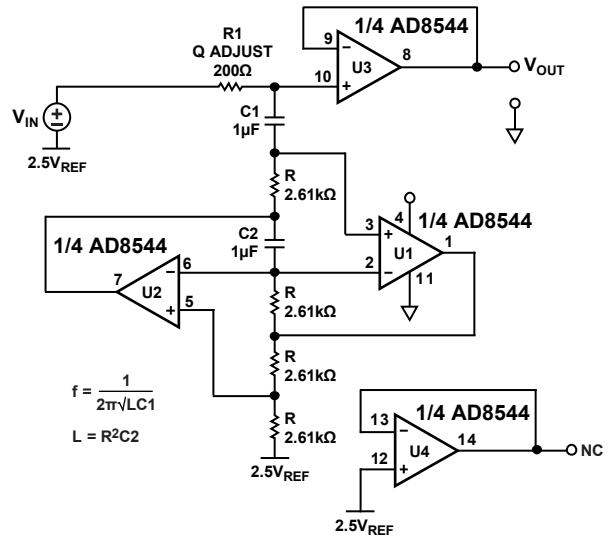

Figure 38. FDNR 60 Hz Notch Filter with Output Buffer

### COMPARATOR FUNCTION

A comparator function is a common application for a spare op amp in a quad package. Figure 39 illustrates ¼ of the AD8544 as a comparator in a standard overload detection application. Unlike many op amps, the AD854x family can double as comparators because this op amp family has a rail-to-rail differential input range, rail-to-rail output, and a great speed vs. power ratio. R2 is used to introduce hysteresis. The AD854x, when used as comparators, have 5 μs propagation delay at 5 V and 5 μs overload recovery time.

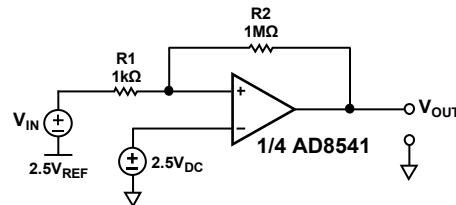

Figure 39. AD854x Comparator Application—Overload Detector

## PHOTODIODE APPLICATION

The AD854x family has very high impedance with an input bias current typically around 4 pA. This characteristic allows the AD854x op amps to be used in photodiode applications and other applications that require high input impedance. Note that the AD854x has significant voltage offset that can be removed by capacitive coupling or software calibration.

Figure 40 illustrates a photodiode or current measurement application. The feedback resistor is limited to 10 M $\Omega$  to avoid excessive output offset. In addition, a resistor is not needed on the noninverting input to cancel bias current offset because the bias current-related output offset is not significant when compared to the voltage offset contribution. For best performance, follow the standard high impedance layout techniques, which include the following:

- Shielding the circuit.
- Cleaning the circuit board.
- Putting a trace connected to the noninverting input around the inverting input.
- Using separate analog and digital power supplies.



Figure 40. High Input Impedance Application—Photodiode Amplifier

01895-039

OUTLINE DIMENSIONS



COMPLIANT TO JEDEC STANDARDS MO-178-AA

Figure 41. 5-Lead Small Outline Transistor Package [SOT-23] (RJ-5)

Dimensions shown in millimeters

11-012810-A

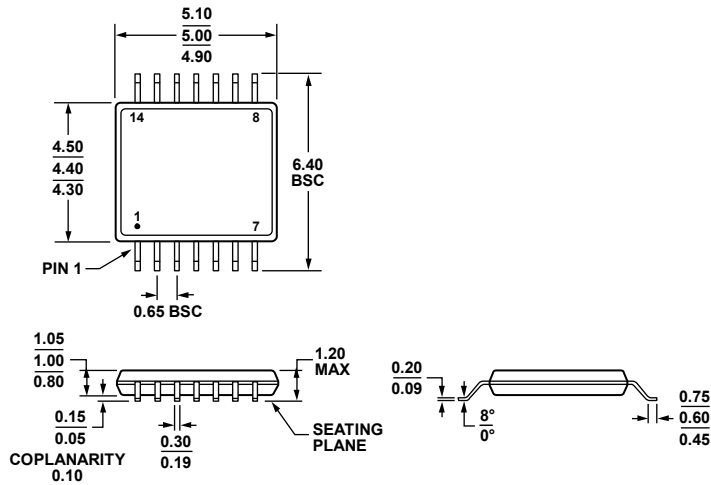

COMPLIANT TO JEDEC STANDARDS MO-153-AB-1

Figure 42. 14-Lead Thin Shrink Small Outline Package [TSSOP] (RU-14)

Dimensions shown in millimeters

061908-A



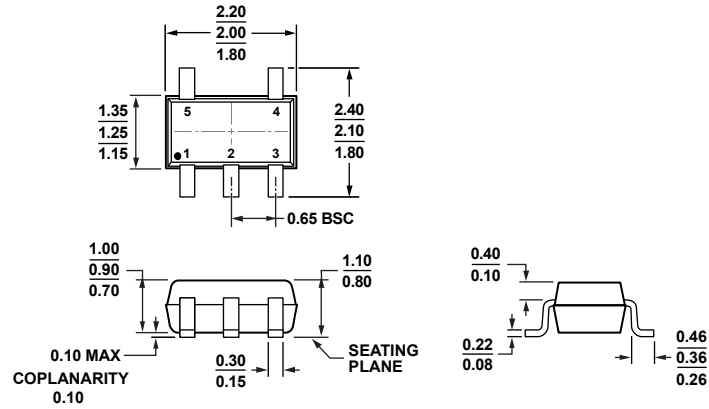

COMPLIANT TO JEDEC STANDARDS MO-203-AA

Figure 43. 5-Lead Thin Shrink Small Outline Transistor Package [SC70] (KS-5)

Dimensions shown in millimeters

072809-A

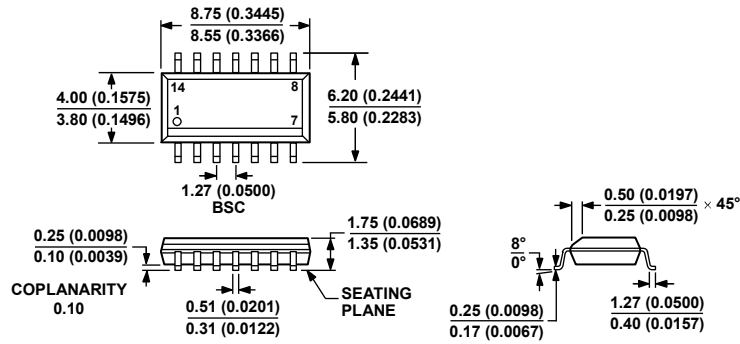

COMPLIANT TO JEDEC STANDARDS MS-012-AB

CONTROLLING DIMENSIONS ARE IN MILLIMETERS; INCH DIMENSIONS (IN PARENTHESES) ARE ROUNDED-OFF MILLIMETER EQUIVALENTS FOR REFERENCE ONLY AND ARE NOT APPROPRIATE FOR USE IN DESIGN.

Figure 44. 14-Lead Standard Small Outline Package [SOIC\_N] Narrow Body (R-14)

Dimensions shown in millimeters and (inches)

060606-A

# AD8541/AD8542/AD8544



COMPLIANT TO JEDEC STANDARDS MO-187-AA

Figure 45. 8-Lead Mini Small Outline Package [MSOP] (RM-8)

Dimensions shown in millimeters

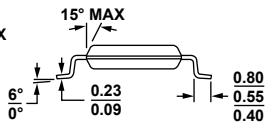

10-07-2009-B

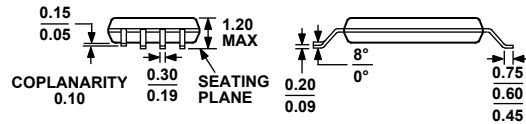
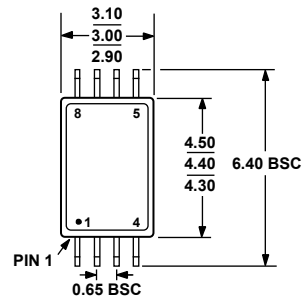

COMPLIANT TO JEDEC STANDARDS MO-153-AA

Figure 46. 8-Lead Thin Shrink Small Outline Package [TSSOP] (RU-8)

Dimensions shown in millimeters

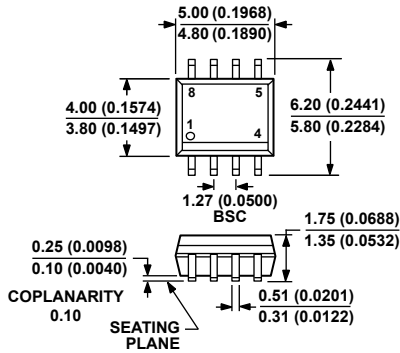

COMPLIANT TO JEDEC STANDARDS MS-012-AA

CONTROLLING DIMENSIONS ARE IN MILLIMETERS; INCH DIMENSIONS (IN PARENTHESES) ARE ROUNDED-OFF MILLIMETER EQUIVALENTS FOR REFERENCE ONLY AND ARE NOT APPROPRIATE FOR USE IN DESIGN.

Figure 47. 8-Lead Standard Small Outline Package [SOIC\_N] Narrow Body (R-8)

Dimensions shown in millimeters and (inches)

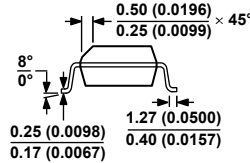

012407-A

**ORDERING GUIDE**

| Model <sup>1, 2</sup> | Temperature Range | Package Description | Package Option | Branding |
|-----------------------|-------------------|---------------------|----------------|----------|
| AD8541AKSZ-R2         | -40°C to +125°C   | 5-Lead SC70         | KS-5           | A12      |
| AD8541AKSZ-REEL7      | -40°C to +125°C   | 5-Lead SC70         | KS-5           | A12      |
| AD8541ARTZ-R2         | -40°C to +125°C   | 5-Lead SOT-23       | RJ-5           | A4A      |
| AD8541ARTZ-REEL       | -40°C to +125°C   | 5-Lead SOT-23       | RJ-5           | A4A      |
| AD8541ARTZ-REEL7      | -40°C to +125°C   | 5-Lead SOT-23       | RJ-5           | A4A      |
| AD8541ARZ             | -40°C to +125°C   | 8-Lead SOIC_N       | R-8            |          |
| AD8541ARZ-REEL        | -40°C to +125°C   | 8-Lead SOIC_N       | R-8            |          |
| AD8541ARZ-REEL7       | -40°C to +125°C   | 8-Lead SOIC_N       | R-8            |          |
| AD8542ARZ             | -40°C to +125°C   | 8-Lead SOIC_N       | R-8            |          |
| AD8542ARZ-REEL        | -40°C to +125°C   | 8-Lead SOIC_N       | R-8            |          |
| AD8542ARZ-REEL7       | -40°C to +125°C   | 8-Lead SOIC_N       | R-8            |          |
| AD8542ARM-REEL        | -40°C to +125°C   | 8-Lead MSOP         | RM-8           | AVA      |
| AD8542ARMZ            | -40°C to +125°C   | 8-Lead MSOP         | RM-8           | AVA      |
| AD8542ARMZ-REEL       | -40°C to +125°C   | 8-Lead MSOP         | RM-8           | AVA      |
| AD8542ARU-REEL        | -40°C to +125°C   | 8-Lead TSSOP        | RU-8           |          |
| AD8542ARUZ            | -40°C to +125°C   | 8-Lead TSSOP        | RU-8           |          |
| AD8542ARUZ-REEL       | -40°C to +125°C   | 8-Lead TSSOP        | RU-8           |          |
| AD8544ARZ             | -40°C to +125°C   | 14-Lead SOIC_N      | R-14           |          |
| AD8544ARZ-REEL        | -40°C to +125°C   | 14-Lead SOIC_N      | R-14           |          |
| AD8544ARZ-REEL7       | -40°C to +125°C   | 14-Lead SOIC_N      | R-14           |          |
| AD8544ARUZ            | -40°C to +125°C   | 14-Lead TSSOP       | RU-14          |          |
| AD8544ARUZ-REEL       | -40°C to +125°C   | 14-Lead TSSOP       | RU-14          |          |
| AD8544WARZ-RL         | -40°C to +125°C   | 14-Lead SOIC_N      | R-14           |          |
| AD8544WARZ-R7         | -40°C to +125°C   | 14-Lead SOIC_N      | R-14           |          |

<sup>1</sup> Z = RoHS Compliant Part.

<sup>2</sup> W = Qualified for Automotive Applications.

**AUTOMOTIVE PRODUCTS**

The AD8544W models are available with controlled manufacturing to support the quality and reliability requirements of automotive applications. Note that these automotive models may have specifications that differ from the commercial models; therefore, designers should review the Specifications section of this data sheet carefully. Only the automotive grade products shown are available for use in automotive applications. Contact your local Analog Devices account representative for specific product ordering information and to obtain the specific Automotive Reliability reports for these models.

**NOTES**