

HD Lötstift gewinkelt 90°, 7.9 mm

Gedrehte Kontakte

90° HD Solder pin, 7.9 mm

Machined contacts

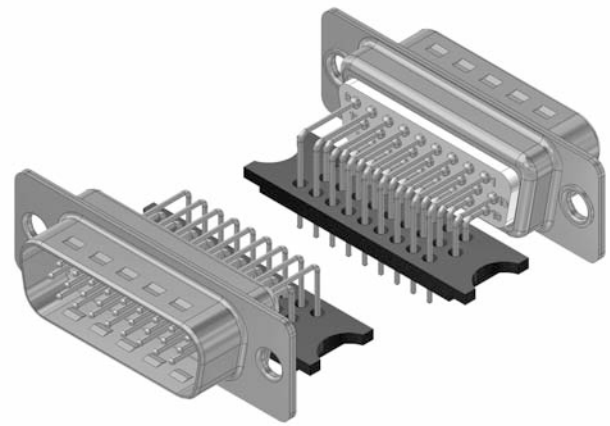

Stiftleiste

Plug connector

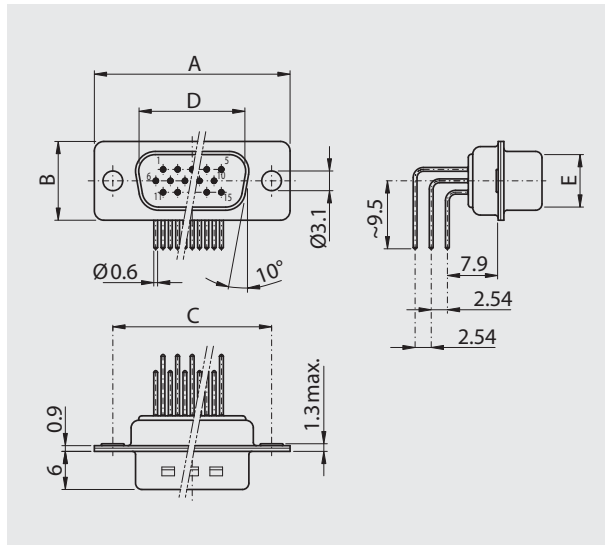

Buchsenleiste

Socket connector

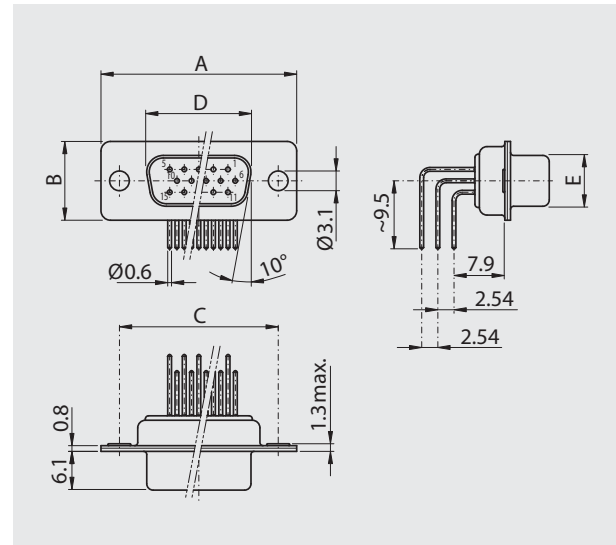

Polzahl

No. of pos.	A	B	C	D	E
15	30.80	12.40	25.00	16.79	08.23
26	39.20	12.40	33.30	25.12	08.23
44	53.10	12.40	47.04	38.84	08.23
62	69.50	12.40	63.50	55.30	08.23

Polzahl

No. of pos.	A	B	C	D	E
15	30.80	12.40	25.00	16.46	08.02
26	39.20	12.40	33.30	24.79	08.02
44	53.10	12.40	47.04	38.50	08.02
62	69.50	12.40	63.50	54.96	08.02

Bestellbezeichnung

Polzahl	Gehäuse chromatiert	Gehäuse verzinkt
No. of pos.	Chromated shell	Tinned shell
15		HD-D 15 PYC x
26		HD-D 26 PYC x
44		HD-D 44 PYC x
62		HD-D 62 PYC x

Anstelle des x am Ende der Artikelbezeichnung die gewünschte Güteklasse 1 oder 2 einfügen.
Andere Vergoldungen auf Anfrage.

Order information

Polzahl	Gehäuse chromatiert	Gehäuse verzinkt
No. of pos.	Chromated shell	Tinned shell
15		HD-D 15 SYC x
26		HD-D 26 SYC x
44		HD-D 44 SYC x
62		HD-D 62 SYC x

To request class 1 or 2 quality, replace the x at the end of the part no.
Other gold platings on request.

Montagearten; Bauhöhe 6.3 mm

Für Lötstift 90°, 7.9 mm (YC)

Assemblies; mounting height 6.3 mm

For solder pin 90°, 7.9 mm (YC)

M46H x

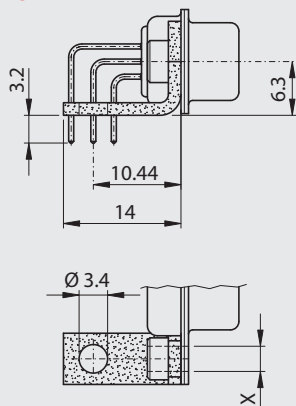

Metallwinkel / Metal bracket

M46H D3 Niete / rivet \varnothing 3.1 mm

M46H UN Niete / back nut UNC4-40

M46H M3 Niete / back nut M3

M46H xx

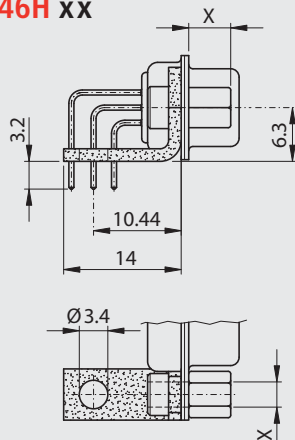

Metallwinkel / Metal bracket

M46H UN B5 Niete / back nut UNC4-40

Schraube / screw 5 mm

M46H UN B6 Niete / back nut UNC4-40

Schraube / screw 6 mm

M46H M3 B5 Niete / back nut M3

Schraube / screw 5 mm

M46H M3 B6 Niete / back nut M3

Schraube / screw 6 mm

M47H x

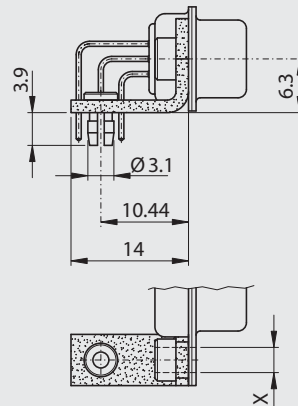

Metallwinkel mit P.o.F.
Metal bracket with P.o.F.

M47H D3 Niete / rivet \varnothing 3.1 mm

M47H UN Niete / back nut UNC4-40

M47H M3 Niete / back nut M3

M47H xx

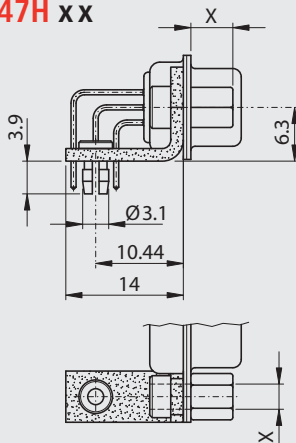

Metallwinkel mit P.o.F.
Metal bracket with P.o.F.

M47H UN B5 Niete / back nut UNC4-40

Schraube / screw 5 mm

M47H UN B6 Niete / back nut UNC4-40

Schraube / screw 6 mm

M47H M3 B5 Niete / back nut M3

Schraube / screw 5 mm

M47H M3 B6 Niete / back nut M3

Schraube / screw 6 mm

YC

Stiftleiste
Plug connector

Buchsenleiste
Socket connector

15 Kontakte
Contacts

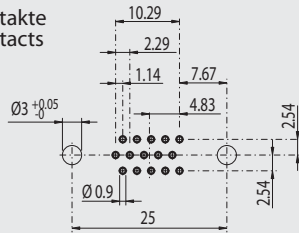

15 Kontakte
Contacts

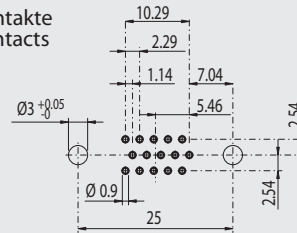

26 Kontakte
Contacts

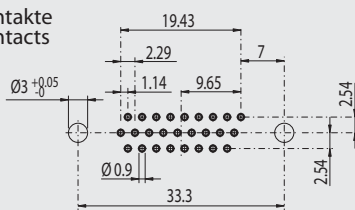

26 Kontakte
Contacts

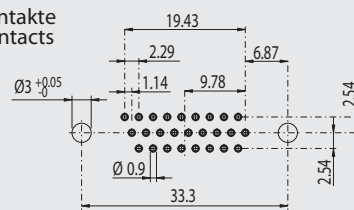

44 Kontakte
Contacts

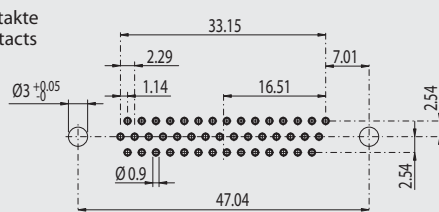

44 Kontakte
Contacts

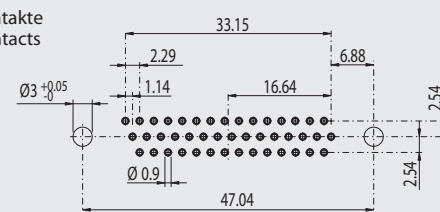

62 Kontakte
Contacts

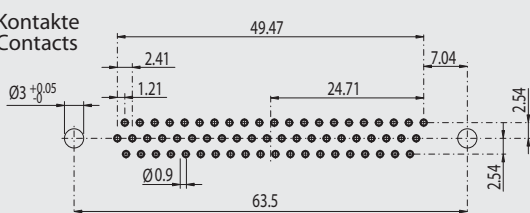

62 Kontakte
Contacts

