

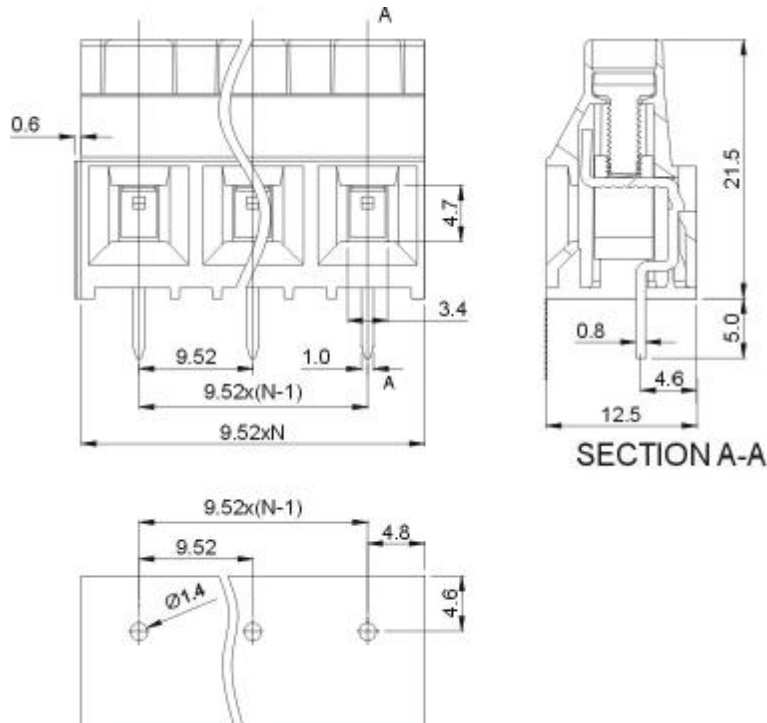



**DG636-9.52**





APPROVAL		
Electrical		
Standard	UL	IEC
Rated voltage	300V	1000V
Rated current	30A	24A
Wire range	26-10AWG	4.0mm <sup>2</sup>
Withstanding voltage	AC3500V/1Min	

Mechanical		
Torque	0.5Nm(4.4Lb-In)	
Ambient temperature	-40°C ~+105 °C	
Strip length	8mm	
Dimensions		
pitch	9.52mm(.375" )	
Poles	2P,3P-24P	

Material		
Housing	PA66,UL94V-0	
Screws	M3,Steel, Cr <sup>3+</sup> Znplated	
Pin header	Copper, Tin-plated	
Cage	Brass, Ni-plated	

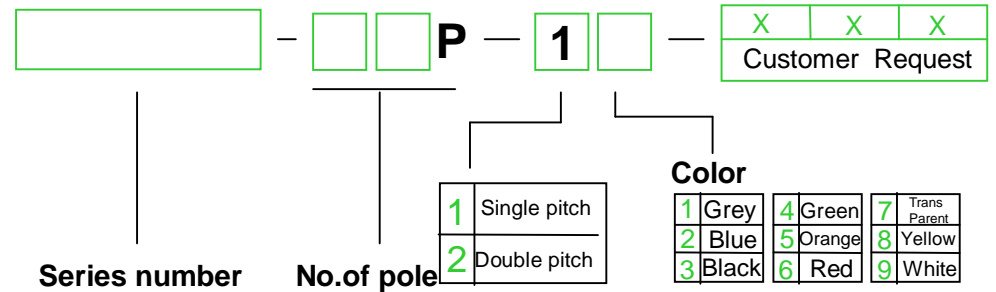
### HOW TO ORDER :

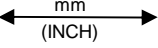

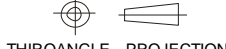
 mm (INCH)	 <b>DEGSON ELECTRONICS CO., LTD.</b>
 THROANGLE PROJECTION	<b>NAME</b> <span style="float: right;"><b>DG636-9.52</b></span>