

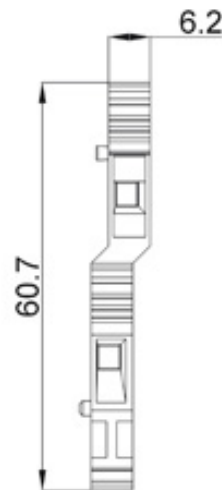

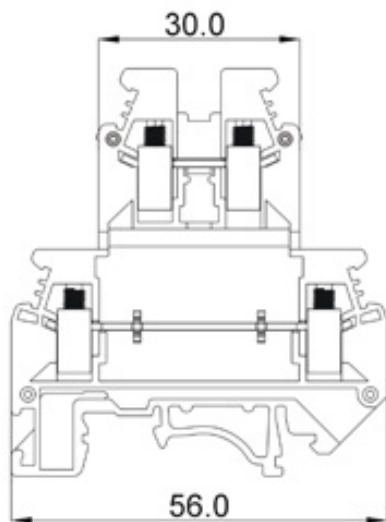







PCKK4

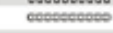

Capability		
Approval		
Standard	UL	IEC
Rated Voltage	600V	500V
Rated Current	30A	32A
Wire size	24-12AWG	0.2-4mm ²
T/W/End plate		6.2/56/2.6mm
Height _{mm} (NS35:7.5/NS35:15/NS32)		62/69.5/67mm
Rated Surge Voltage/Contamination Class		6KV/3
Stripping Length		8mm
Screw Thread/Tightening Torque		M3/0.5N.m/4.5Lb-in
Internal Cylindrical Gage		A4
Insulating Material/Inflammability Class		PAV-0

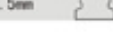
Specification	Model	Pieces		
(1) Terminal Block	PCKK4	50		
(2) End Cover	D-PCKK2.5/4	50		
(3) Fixed Bridge	2-P 3-P 5-P 10-P	 FBI 10-6	10	
(4) Step Bracket				
(5) Insertion Bridge	2-P 3-P 10-P		EB 2-6 EB 3-6 EB 10-6	100 100 10
(6) Isolator Bridge Bar, 10 P		DG-PCKK 2.5/4	50	
(7) Bridge Bar Isolator		DP-PCKK 2.5/4	50	
(8) Switching Bridge		PCKK 4-PV	50	
(9) Separating Plate		TS-KK3	50	
(10) Separating Plate, Width:1.5mm		ATP-PCKK 2.5/4	50	
(11) Test Plug Socket		ISSBI 10-6	1	
(12) Test Plug Socket, Insulated		IS-K4	100	
(13) Zack Strip		ZB6		

HOW TO ORDER:

PCKK4 — P — — —

X	X	X
Customer Request		

Series No. No. of Pole Color

1 Gray	4 Green	7 Trans-parent
2 Blue	5 Orange	8 Yellow
3 Black	6 Red	9 White

	 DEGSON ELECTRONICS CO., LTD.
	NAME PCKK4