

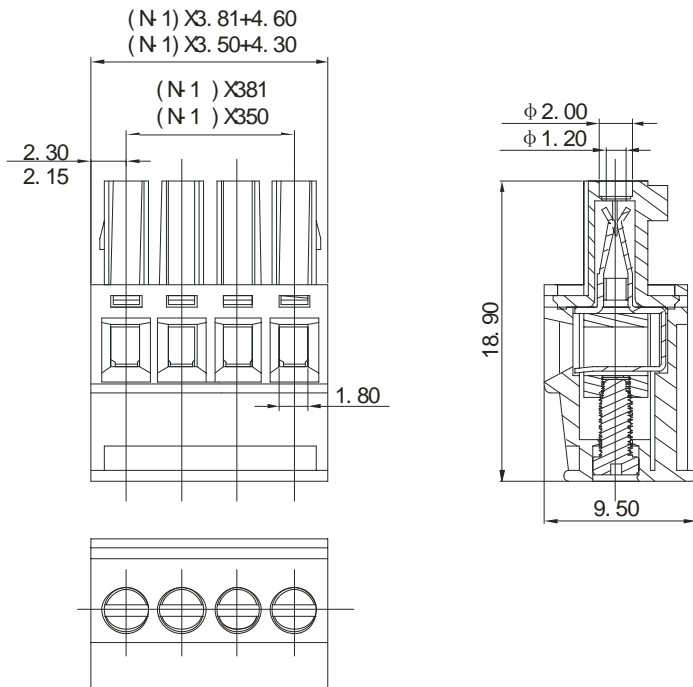





**15EDGKB-3.5**  
**15EDGKB-3.81**

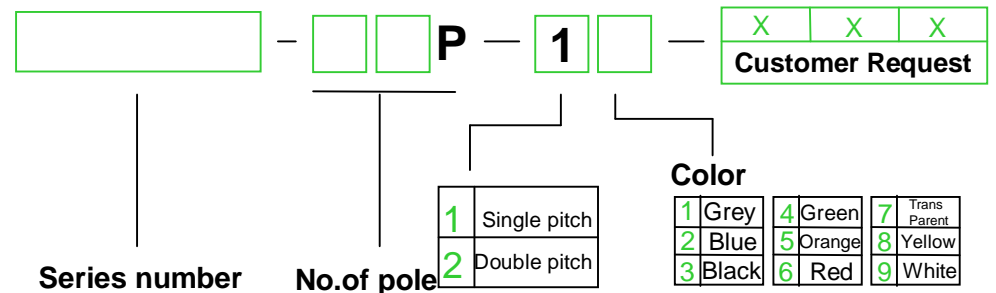

<b>APPROVAL</b>		
<b>Electrical</b>		
Standard	<b>UL</b>	<b>IEC</b>
Rated voltage	300V	250V
Rated current	8A	7A
Wire range	28-16AWG	0.5-1.5mm <sup>2</sup>
Withstanding voltage	AC2000V/1Min	
<b>Mechanical</b>		
Torque	0.2Nm(1.7Lb-In)	
Ambient temperature	-30℃~+120℃	
Strip length	7mm	
<b>Dimensions</b>		
Pitch	3.5mm(.138") 3.81mm(.150")	
Poles	2P-24P	
<b>Material</b>		
Housing	PBT,UL94V-0	
Screws	M2,Steel,Cr <sup>3+</sup> Zn-plated	
Contact	Phosphor bronze	
Cage	Brass,Ni-plated	

### HOW TO ORDER :

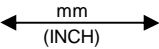

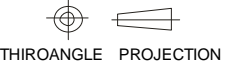
 mm (INCH)	 <b>DEGSON ELECTRONICS CO., LTD.</b>
 THROANGLE PROJECTION	<b>NAME</b> <b>15EDGKB-3.5, 15EDGKB-3.81</b>