

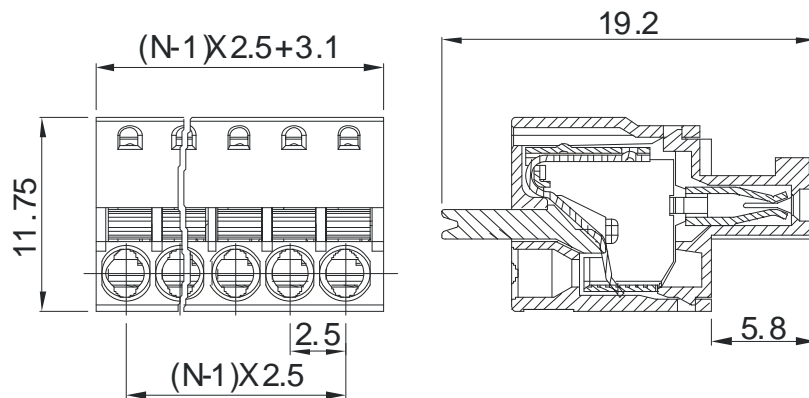





**15EDGKD-2.5**

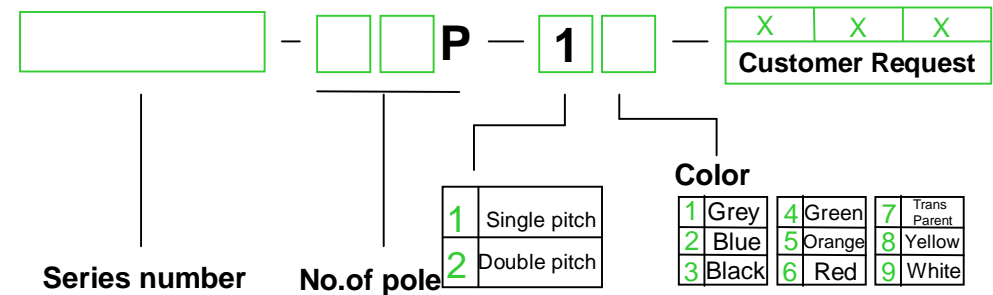

<b>APPROVAL</b>		
<b>Electrical</b>		
Standard	<b>UL</b>	<b>IEC</b>
Rated voltage	150V	250V
Rated current	4A	5A
Wire range	20AWG	0.2-0.5mm <sup>2</sup>
Withstanding voltage	AC1250V/1Min	
<b>Mechanical</b>		
Ambient temperature	-40°C~+105 °C	
Strip length	8mm	
<b>Dimensions</b>		
Pitch	2.5mm(.098" )	
Poles	2P-12P	
<b>Material</b>		
Housing	PA66,UL94V-0	
Contact	Phosphor bronze	
Wire guard	Stainless steel	

### HOW TO ORDER :

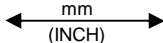

	 <b>DEGSON ELECTRONICS CO., LTD.</b>
	<b>NAME</b> <b>15EDGKD-2.5</b>