

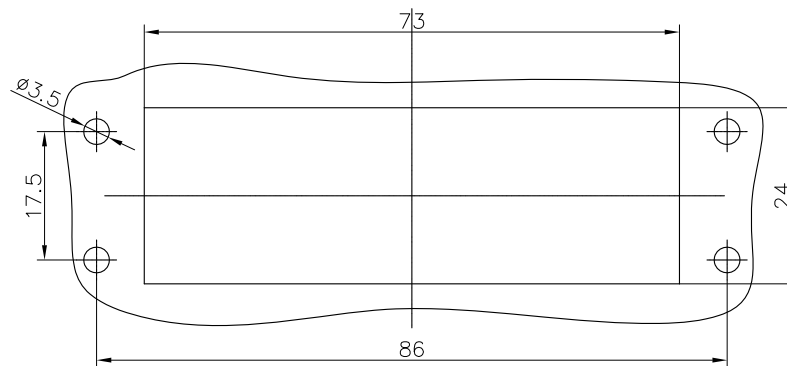

REVISION RECORD				
REV	ECN	DESCRIPTION	DRFT	DATE

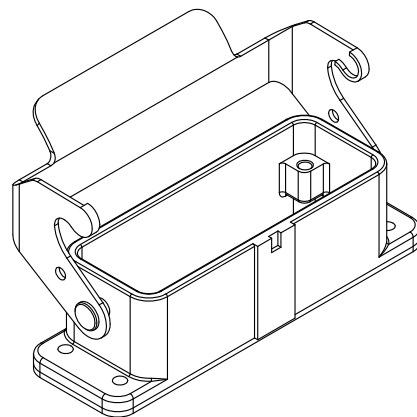
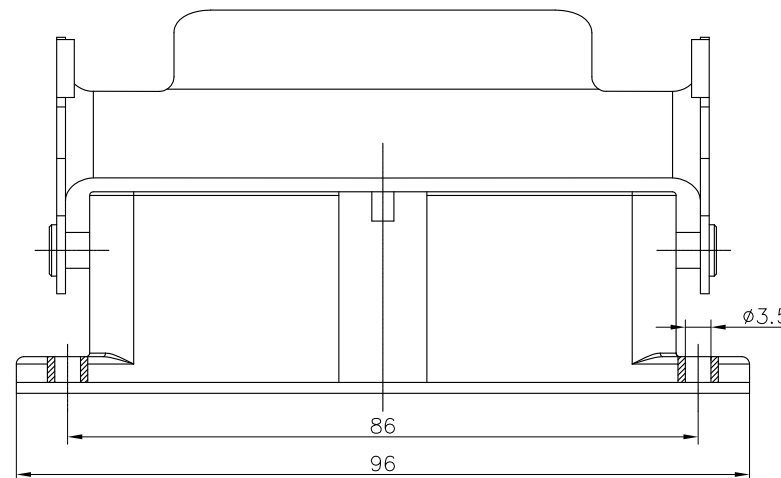
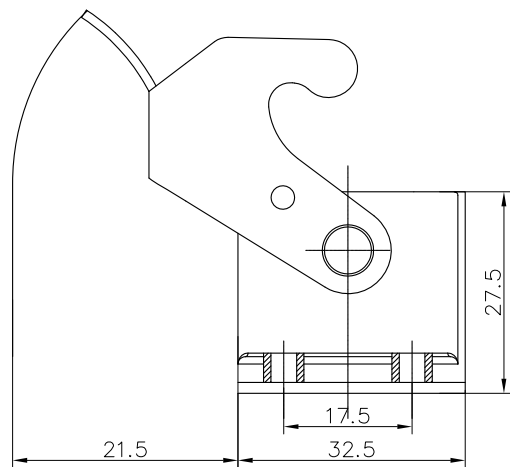

Panel cut out

Housings Feature:

1. Material: Aluminium alloy
2. Color: grey (RAL 7037)
3. Locking element, Lever type: Lever
4. Material: Metal zinc-plated (Lever)
5. Seal: NBR
6. Limiting temperatures: $-40^{\circ}\text{C} \sim +125^{\circ}\text{C}$
7. Flammability acc. to UL94: V0
8. Degree of protection acc. to EN60529 for coupled connector: IP65
9. Rohs Compliance

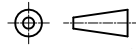
DETACHED LISTS	PART NO.:	/	 宁波高松电子有限公司 NINGBO DEGSON ELECTRICAL CO., LTD	
	APPD:		NAME: D16A-BK-1L	
	CHKD:		TITLE: CUSTOMER DRAWING	
	DRFT: Mr. Yang 2016.08.08		REV	DO
	 THIRD ANGLE PROJECTION		DRAWING NO.:	/
		MM (INCH)	DO NOT SCALE DRAWING	SCALE