

Góra

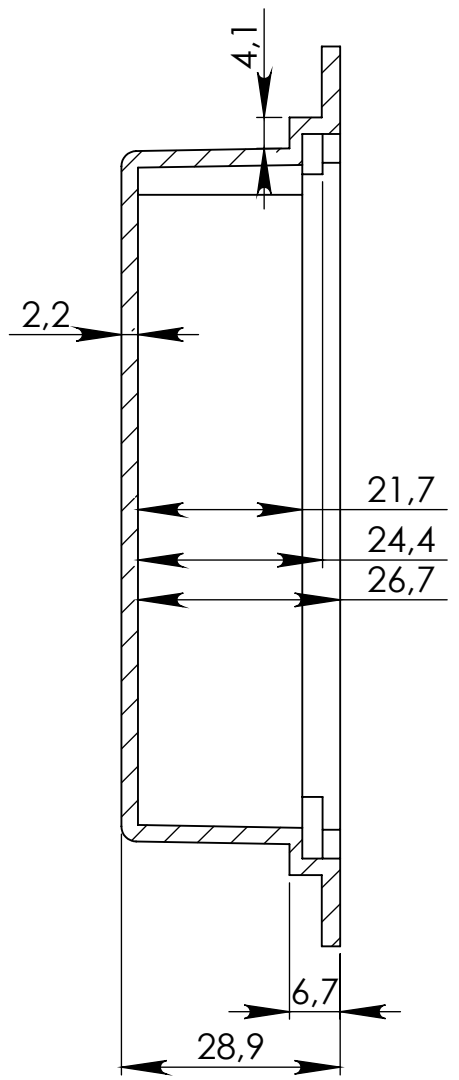

Dół

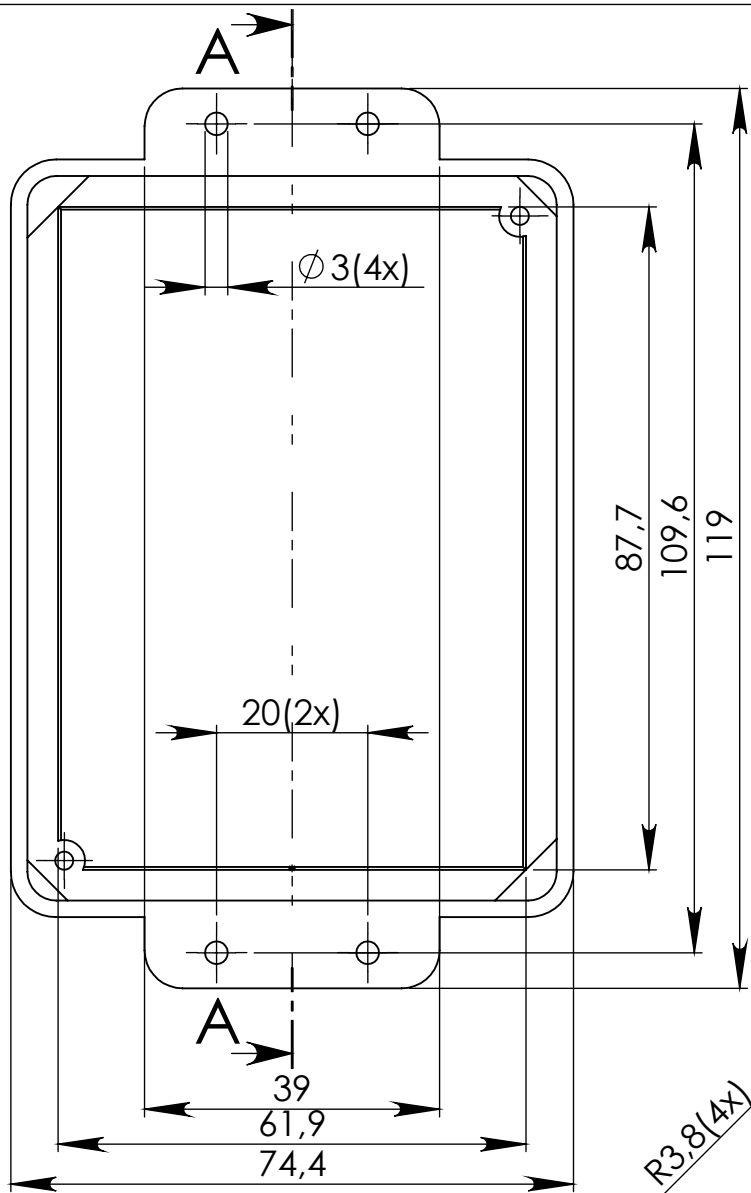
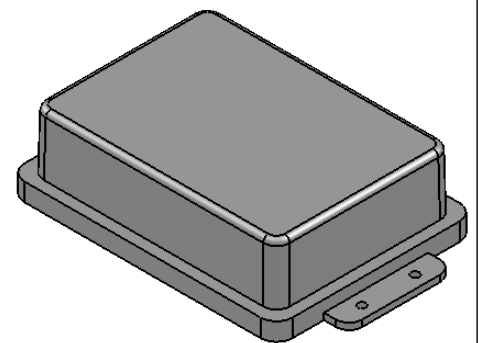
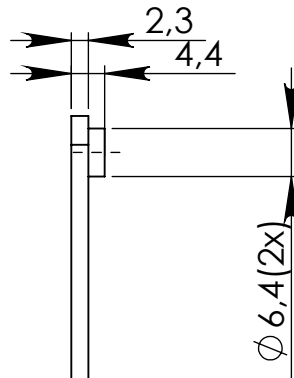
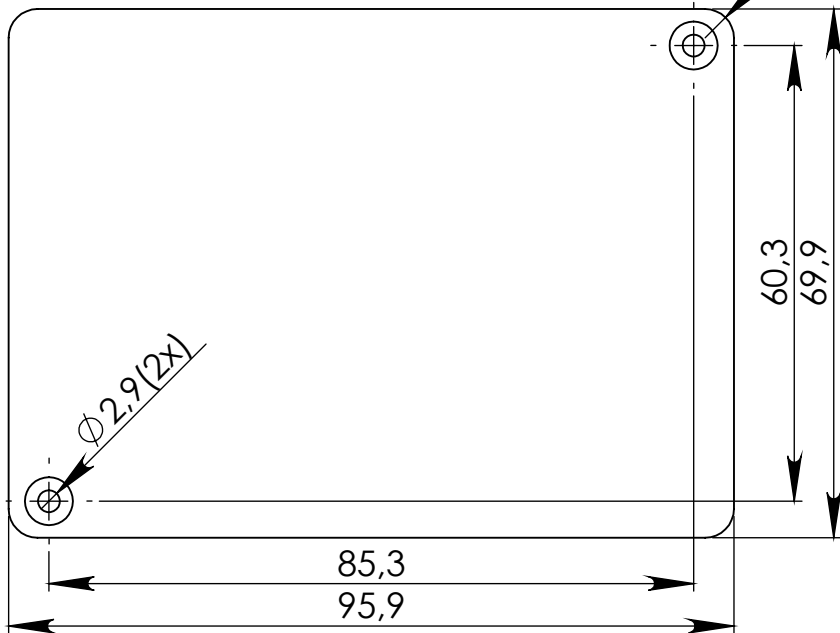

UWAGA: Wymiary w tolerancji $\pm 0,5\text{mm}$

Elementy składowe:
 - obudowa góra,
 - obudowa dół,
 - 2 wkręty,

Format	Skala
A4	1:1

Nr produktu
KM 29



MASZCZYK®

Krzysztof Maszczyk
 05-071 Sulejówek-Miłosna
 ul. Mickiewicza 10
 tel.: (022)783 45 20, fax.: (022)783 90 85
 kom: 0602 726 086